

Product Summary

V _{RRM} (V)	I _o (A)	V _F MAX (V)	I _R MAX (μA)
40	1	0.56	75

Description and Applications

The SDM1A40CP3 is a 40-volt 1A Schottky barrier rectifier that is optimized for low forward voltage drop and low leakage current, housed in a compact die size surface mounted package that occupies only 0.6mm² board-space. The low thermal resistance enables designers to meet design challenges of increasing efficiency while at the same time reducing board space. It is ideally suited for use in portable applications as a:

- Blocking Diode
- Boost Diode
- Switching Diode
- Reverse Protection Diode

Features and Benefits

- Off Board Profile of 0.275mm – More Than 30% Thinner Than DFN1006
- Low Forward Voltage (V_F) Minimizes Conduction Losses and Improves Efficiency
- Reduced High Temperature Reverse Leakage; Increased Reliability Against Thermal Runaway Failure in High Temperature Operation
- **Totally Lead-Free & Fully RoHS Compliant (Notes 1 & 2)**
- **Halogen and Antimony Free. "Green" Device (Note 3)**
- **For automotive applications requiring specific change control (i.e. parts qualified to AEC-Q100/101/200, PPAP capable, and manufactured in IATF 16949 certified facilities), please [contact us](#) or your local Diodes representative. <https://www.diodes.com/quality/product-definitions/>**

Mechanical Data

- Case: X3-DSN1006-2
- Moisture Sensitivity: Level 1 per J-STD-020
- Terminals: NiAu Bump. Solderable per MIL-STD-202, Method 208 **(e4)**
- Polarity: Cathode Dot
- Weight: 0.001 grams (Approximate)

Ordering Information (Note 4)

Part Number	Case	Packaging
SDM1A40CP3-7	X3-DSN1006-2	5,000/ Reel

- Notes:
1. No purposely added lead. Fully EU Directive 2002/95/EC (RoHS), 2011/65/EU (RoHS 2) & 2015/863/EU (RoHS 3) compliant.
 2. See <https://www.diodes.com/quality/lead-free/> for more information about Diodes Incorporated's definitions of Halogen- and Antimony-free, "Green" and Lead-free.
 3. Halogen- and Antimony-free "Green" products are defined as those which contain <900ppm bromine, <900ppm chlorine (<1500ppm total Br + Cl) and <1000ppm antimony compounds.
 4. For packaging details, go to our website at <https://www.diodes.com/design/support/packaging/diodes-packaging/>.

Marking Information

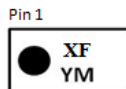

XF = Product Type Marking Code
 YM = Date Code Marking
 Y or \bar{Y} = Year (ex: G = 2019)
 M = Month (ex: 9 = September)
 Dot Denotes Cathode Pin

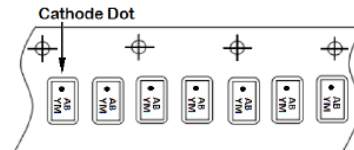

Date Code Key

Year	2016	2017	2018	2019	2020	2021	2022
Code	D	E	F	G	H	I	J

Month	Jan	Feb	Mar	Apr	May	Jun	Jul	Aug	Sep	Oct	Nov	Dec
Code	1	2	3	4	5	6	7	8	9	O	N	D

Maximum Ratings (@T_A = +25°C, unless otherwise specified.)

Single phase, half wave, 60Hz, resistive or inductive load.
For capacitive load, derate current by 20%.

Characteristic	Symbol	Value	Unit
Peak Repetitive Reverse Voltage	V _{RRM}	40	V
Reverse Voltage	V _R	40	V
Average Rectified Output Current	I _O	1	A
Repetitive Peak Forward Current (Pulse Wave = 1ms, Duty Cycle = 25%)	I _{FRM}	5	A
Non-Repetitive Peak Forward Surge Current 8.3ms Single Half Sine-Wave Superimposed on Rated Load	I _{FSM}	14	A

Thermal Characteristics

Characteristic	Symbol	Value	Unit
Typical Thermal Resistance Junction to Ambient (Note 5)	R _{θJA}	150	°C/W
Typical Thermal Resistance Junction to Ambient (Note 6)	R _{θJA}	60	°C/W
Operating and Storage Temperature Range	T _J , T _{STG}	-55 to +150	°C

Electrical Characteristics (@T_A = +25°C, unless otherwise specified.)

Characteristic	Symbol	Min	Typ	Max	Unit	Test Condition
Forward Voltage Drop	V _F	—	0.42	0.46	V	I _F = 0.5A, T _J = +25°C
		—	0.51	0.56		I _F = 1.0A, T _J = +25°C
		—	0.50	—		I _F = 1.0A, T _J = +125°C
Leakage Current (Note 7)	I _R	—	—	15	μA	V _R = 10V, T _J = +25°C
		—	—	75		V _R = 40V, T _J = +25°C
		—	9	—		V _R = 40V, T _J = +125°C
Junction Capacitance	C _T	—	35	—	pF	V _R = 4V, f = 1.0MHz

Notes: 5. Device mounted on FR-4 PCB, 2oz. Copper, minimum recommended pad layout per <http://www.diodes.com/package-outlines.html>.
6. Device mounted on FR-4 PCB, 2oz. 1 square inch Copper.
7. Short duration pulse test used to minimize self-heating effect.

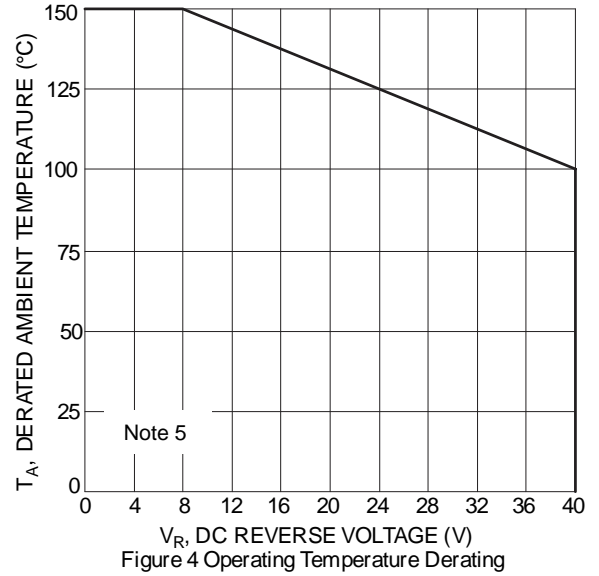
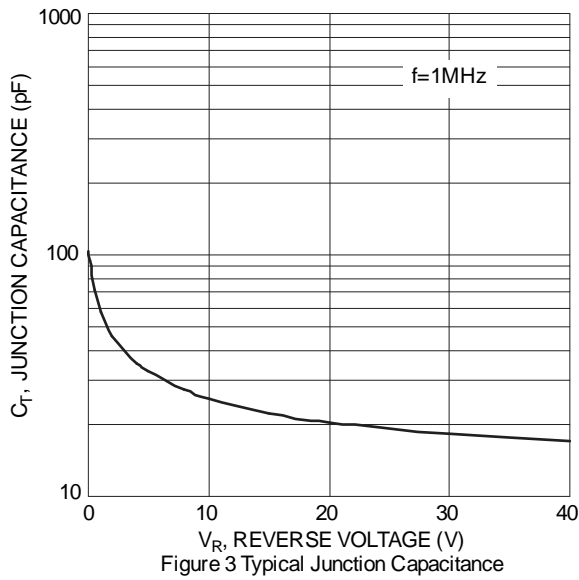
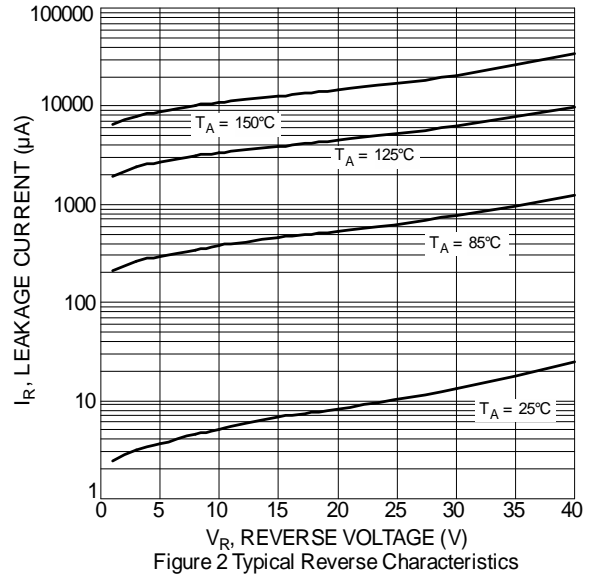
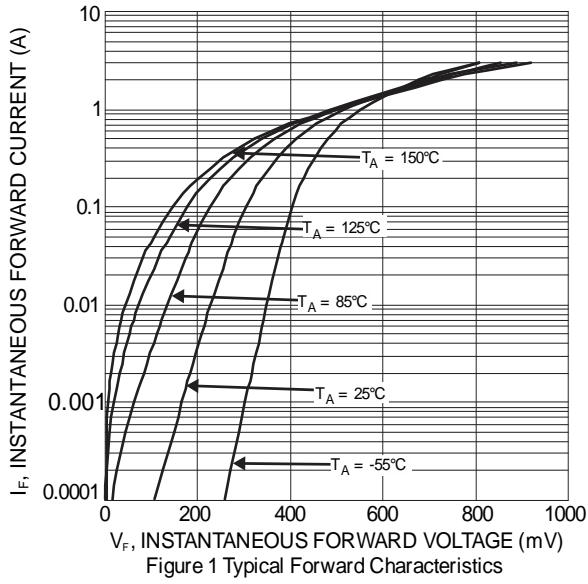

Package Outline Dimensions

Please see <http://www.diodes.com/package-outlines.html> for the latest version.

X3-DSN1006-2

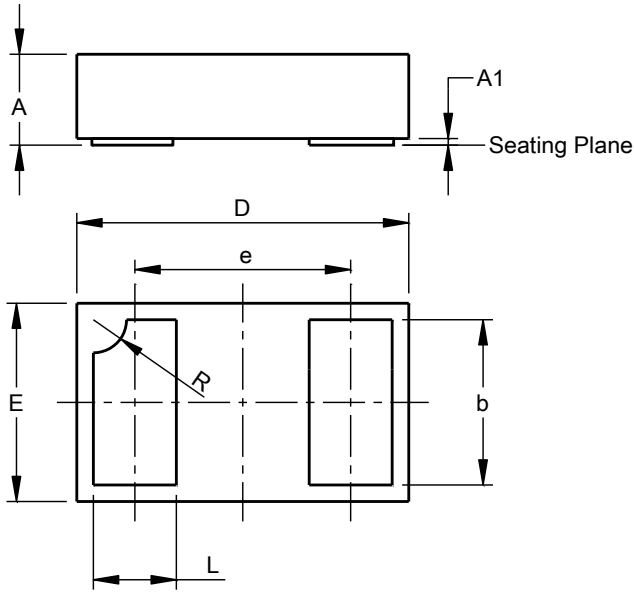

X3-DSN1006-2			
Dim	Min	Max	Typ
A	0.25	0.30	0.275
A1	0.00	0.02	-
b	0.48	0.52	0.50
D	0.95	1.05	1.00
E	0.55	0.65	0.60
e	-	-	0.65
L	0.23	0.27	0.25
R	-	-	0.10
All Dimensions in mm			

Suggested Pad Layout

Please see <http://www.diodes.com/package-outlines.html> for the latest version.

X3-DSN1006-2

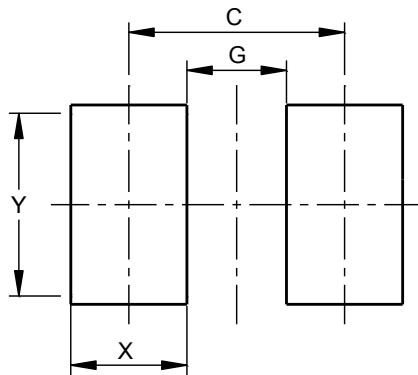

Dimensions	Value (in mm)
C	0.65
G	0.30
X	0.35
Y	0.60

IMPORTANT NOTICE

DIODES INCORPORATED MAKES NO WARRANTY OF ANY KIND, EXPRESS OR IMPLIED, WITH REGARDS TO THIS DOCUMENT, INCLUDING, BUT NOT LIMITED TO, THE IMPLIED WARRANTIES OF MERCHANTABILITY AND FITNESS FOR A PARTICULAR PURPOSE (AND THEIR EQUIVALENTS UNDER THE LAWS OF ANY JURISDICTION).

Diodes Incorporated and its subsidiaries reserve the right to make modifications, enhancements, improvements, corrections or other changes without further notice to this document and any product described herein. Diodes Incorporated does not assume any liability arising out of the application or use of this document or any product described herein; neither does Diodes Incorporated convey any license under its patent or trademark rights, nor the rights of others. Any Customer or user of this document or products described herein in such applications shall assume all risks of such use and will agree to hold Diodes Incorporated and all the companies whose products are represented on Diodes Incorporated website, harmless against all damages.

Diodes Incorporated does not warrant or accept any liability whatsoever in respect of any products purchased through unauthorized sales channel. Should Customers purchase or use Diodes Incorporated products for any unintended or unauthorized application, Customers shall indemnify and hold Diodes Incorporated and its representatives harmless against all claims, damages, expenses, and attorney fees arising out of, directly or indirectly, any claim of personal injury or death associated with such unintended or unauthorized application.

Products described herein may be covered by one or more United States, international or foreign patents pending. Product names and markings noted herein may also be covered by one or more United States, international or foreign trademarks.

This document is written in English but may be translated into multiple languages for reference. Only the English version of this document is the final and determinative format released by Diodes Incorporated.

LIFE SUPPORT

Diodes Incorporated products are specifically not authorized for use as critical components in life support devices or systems without the express written approval of the Chief Executive Officer of Diodes Incorporated. As used herein:

A. Life support devices or systems are devices or systems which:

1. are intended to implant into the body, or
2. support or sustain life and whose failure to perform when properly used in accordance with instructions for use provided in the labeling can be reasonably expected to result in significant injury to the user.

B. A critical component is any component in a life support device or system whose failure to perform can be reasonably expected to cause the failure of the life support device or to affect its safety or effectiveness.

Customers represent that they have all necessary expertise in the safety and regulatory ramifications of their life support devices or systems, and acknowledge and agree that they are solely responsible for all legal, regulatory and safety-related requirements concerning their products and any use of Diodes Incorporated products in such safety-critical, life support devices or systems, notwithstanding any devices- or systems-related information or support that may be provided by Diodes Incorporated. Further, Customers must fully indemnify Diodes Incorporated and its representatives against any damages arising out of the use of Diodes Incorporated products in such safety-critical, life support devices or systems.

Copyright © 2019, Diodes Incorporated

www.diodes.com

单击下面可查看定价，库存，交付和生命周期等信息

[>>Diodes Incorporated\(达达科技\(美台\)\)](#)