

Features

- Epitaxial Planar Die Construction
- Ideally Suited for Automated Assembly Processes
- Ideal for Medium Power Switching or Amplification Applications
- **Lead Free By Design/RoHS Compliant (Note 1)**
- **"Green" Device (Note 2)**

Mechanical Data

- Case: SOT-223
- Case Material: Molded Plastic, "Green" Molding Compound. UL Flammability Classification Rating 94V-0
- Moisture Sensitivity: Level 1 per J-STD-020D
- Terminals: Finish - Matte Tin annealed over Copper Leadframe (Lead Free Plating). Solderable per MIL-STD-202, Method 208
- Marking Information: See Page 4
- Ordering Information: See Page 4
- Weight: 0.115 grams (approximate)

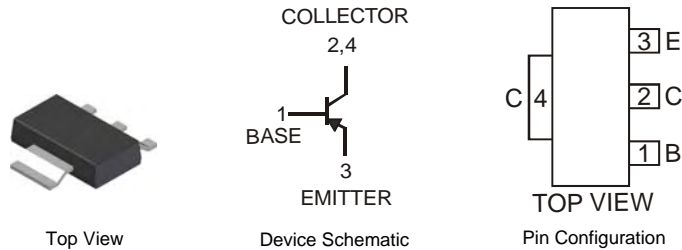

Maximum Ratings @ $T_A = 25^\circ\text{C}$ unless otherwise specified

Characteristic	Symbol	Value	Unit
Collector-Base Voltage	V_{CBO}	-180	V
Collector-Emitter Voltage	V_{CEO}	-140	V
Emitter-Base Voltage	V_{EBO}	-7	V
Continuous Collector Current	I_C	-4	A
Peak Pulse Current	I_{CM}	-10	A

Thermal Characteristics

Characteristic	Symbol	Value	Unit
Power Dissipation (Note 3) @ $T_A = 25^\circ\text{C}$	P_D	1	W
Thermal Resistance, Junction to Ambient Air (Note 3) @ $T_A = 25^\circ\text{C}$	$R_{\theta JA}$	125	$^\circ\text{C/W}$
Operating and Storage Temperature Range	T_J, T_{STG}	-55 to +150	$^\circ\text{C}$

- Notes:
1. No purposefully added lead.
 2. Diodes Inc.'s "Green" policy can be found on our website at http://www.diodes.com/products/lead_free/index.php.
 3. Device mounted on FR-4 PCB; pad layout as shown on page 4 or in Diodes Inc. suggested pad layout document AP02001, which can be found on our website at <http://www.diodes.com/datasheets/ap02001.pdf>.

Electrical Characteristics @ $T_A = 25^\circ\text{C}$ unless otherwise specified

Characteristic	Symbol	Min	Typ	Max	Unit	Test Condition
OFF CHARACTERISTICS (Note 4)						
Collector-Base Breakdown Voltage	$V_{(BR)CBO}$	-180	-230	—	V	$I_C = -100\mu\text{A}, I_E = 0$
Collector-Emitter Breakdown Voltage	$V_{(BR)CEO}$	-140	-190	—	V	$I_C = -10\text{mA}, I_B = 0$
Emitter-Base Breakdown Voltage	$V_{(BR)EBO}$	-7	-8.5	—	V	$I_E = -100\mu\text{A}, I_C = 0$
Collector Cutoff Current	I_{CBO}	—	—	-20 -0.5	nA μA	$V_{CB} = -150\text{V}, I_E = 0$ $V_{CB} = -150\text{V}, I_E = 0,$ $T_A = 100^\circ\text{C}$
Emitter Cutoff Current	I_{EBO}	—	—	-10	nA	$V_{EB} = -6\text{V}, I_C = 0$
ON CHARACTERISTICS (Note 4)						
Collector-Emitter Saturation Voltage	$V_{CE(SAT)}$	—	-40 -50 -75 -175	-60 -80 -120 -360	mV	$I_C = -0.1\text{A}, I_B = -5\text{mA}$ $I_C = -0.5\text{A}, I_B = -50\text{mA}$ $I_C = -1\text{A}, I_B = -100\text{mA}$ $I_C = -3\text{A}, I_B = -300\text{mA}$
Base-Emitter Saturation Voltage	$V_{BE(SAT)}$	—	-910	-1040	mV	$I_C = -3\text{A}, I_B = -300\text{mA}$
Base-Emitter Turn-On Voltage	$V_{BE(ON)}$	—	-810	-930	mV	$I_C = -3\text{A}, V_{CE} = -5\text{V}$
DC Current Gain	h_{FE}	100 100 45 —	— — — 12	— — 300 —	—	$I_C = -10\text{mA}, V_{CE} = -5\text{V}$ $I_C = -1\text{A}, V_{CE} = -5\text{V}$ $I_C = -3\text{A}, V_{CE} = -5\text{V}$ $I_C = -10\text{A}, V_{CE} = -5\text{V}$
SMALL SIGNAL CHARACTERISTICS						
Current Gain-Bandwidth Product	f_T	—	150	—	MHz	$I_C = -100\text{mA}, V_{CE} = -10\text{V},$ $f = 100\text{MHz}$
Output Capacitance	C_{obo}	—	55	—	pF	$V_{CB} = -10\text{V}, f = 1\text{MHz}$
SWITCHING CHARACTERISTICS						
Switching Times	t_{on} t_{off}	— —	85 430	— —	ns	$I_C = -1\text{A}, I_{B1} = -100\text{mA}$ $I_{B2} = 100\text{mA}, V_{CC} = -50\text{V}$

Notes: 4. Measured under pulsed conditions. Pulse width = 300 μs . Duty cycle $\leq 2\%$

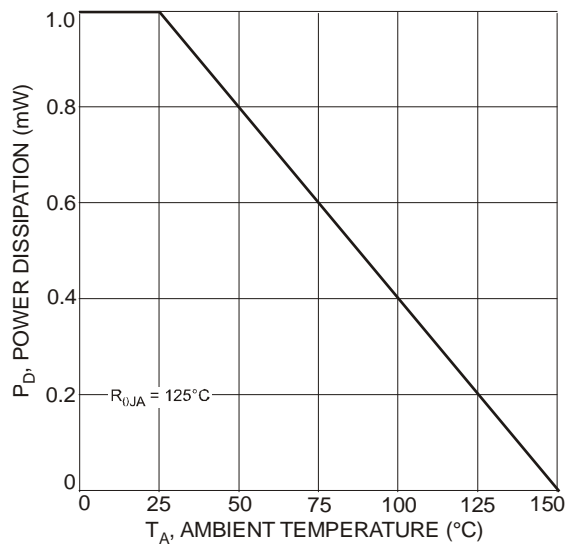

Fig. 1 Power Dissipation vs. Ambient Temperature (Note 3)

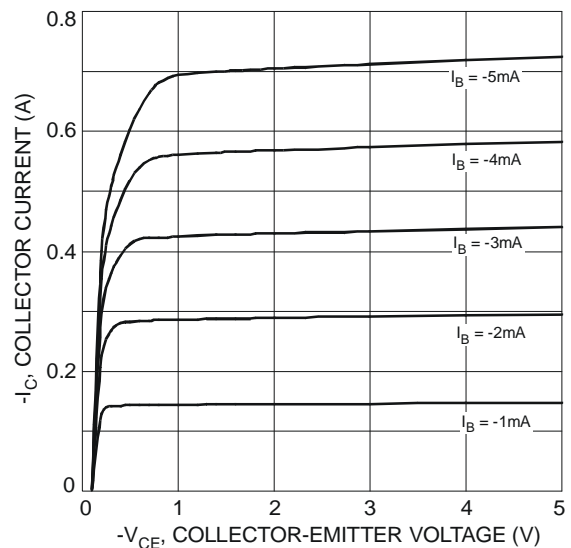

Fig. 2 Typical Collector Current vs. Collector-Emitter Voltage

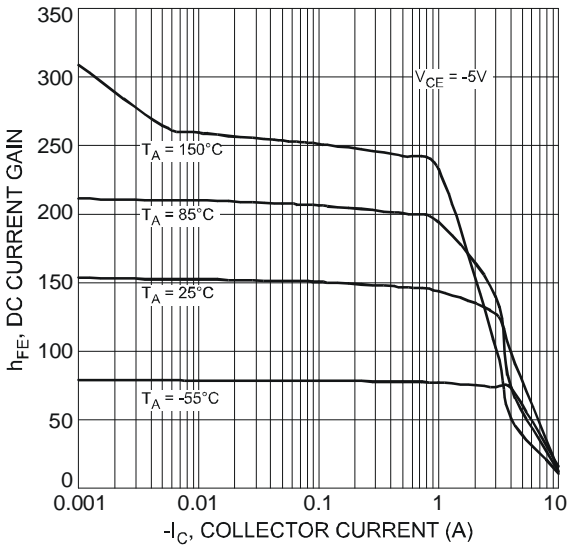

Fig. 3 Typical DC Current Gain vs. Collector Current

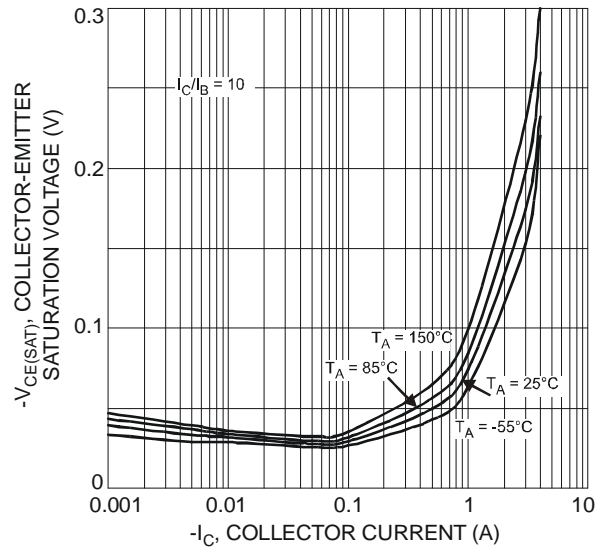

Fig. 4 Typical Collector-Emitter Saturation Voltage vs. Collector Current

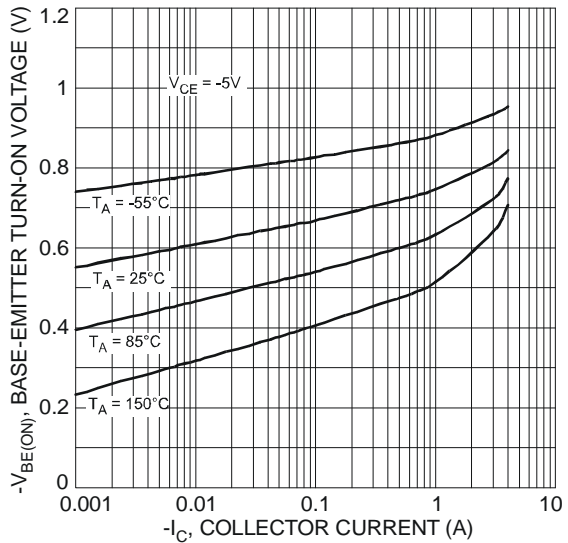

Fig. 5 Typical Base-Emitter Turn-On Voltage vs. Collector Current

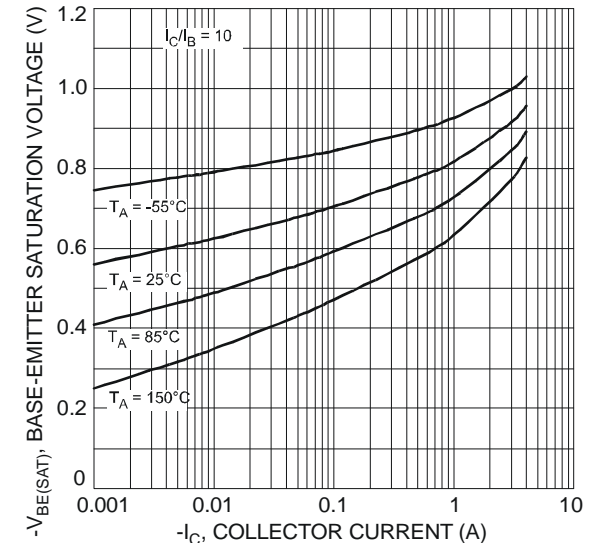

Fig. 6 Typical Base-Emitter Saturation Voltage vs. Collector Current

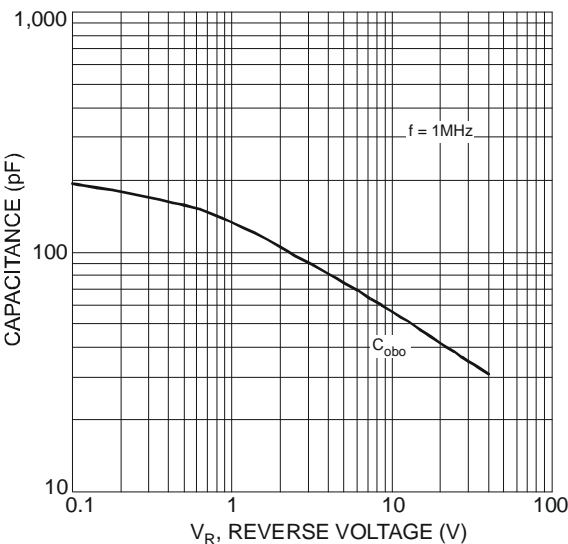

Fig. 7 Typical Capacitance Characteristics

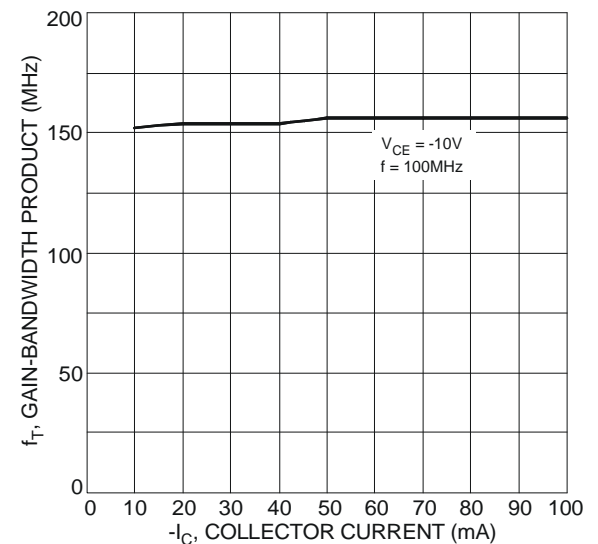

Fig. 8 Typical Gain-Bandwidth Product vs. Collector Current

Ordering Information (Note 5)

Part Number	Case	Packaging
DPLS4140E-13	SOT-223	2500/Tape & Reel

Notes: 5. For packaging details, go to our website at <http://www.diodes.com/datasheets/ap02007.pdf>.

Marking Information

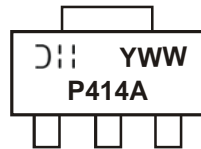

P414A = Product Type Marking Code
 YWW = Date Code Marking
 Y = Last digit of year (ex: 8 = 2008)
 WW = Week code 01 - 52

Package Outline Dimensions

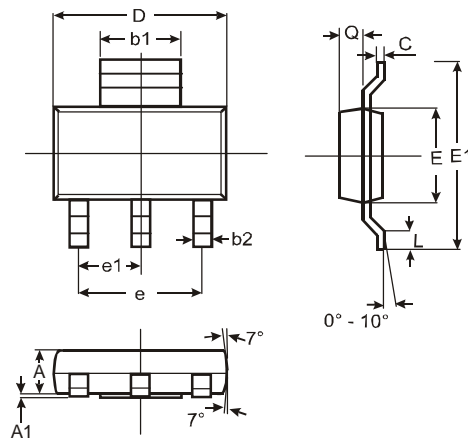

SOT-223			
Dim	Min	Max	Typ
A	1.55	1.65	1.60
A1	0.010	0.15	0.05
b1	2.90	3.10	3.00
b2	0.60	0.80	0.70
C	0.20	0.30	0.25
D	6.45	6.55	6.50
E	3.45	3.55	3.50
E1	6.90	7.10	7.00
e	—	—	4.60
e1	—	—	2.30
L	0.85	1.05	0.95
Q	0.84	0.94	0.89
All Dimensions in mm			

Suggested Pad Layout

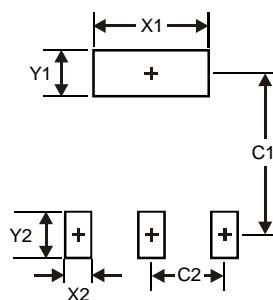

Dimensions	Value (in mm)
X1	3.3
X2	1.2
Y1	1.6
Y2	1.6
C1	6.4
C2	2.3

IMPORTANT NOTICE

Diodes Incorporated and its subsidiaries reserve the right to make modifications, enhancements, improvements, corrections or other changes without further notice to any product herein. Diodes Incorporated does not assume any liability arising out of the application or use of any product described herein; neither does it convey any license under its patent rights, nor the rights of others. The user of products in such applications shall assume all risks of such use and will agree to hold Diodes Incorporated and all the companies whose products are represented on our website, harmless against all damages.

LIFE SUPPORT

Diodes Incorporated products are not authorized for use as critical components in life support devices or systems without the expressed written approval of the President of Diodes Incorporated.

单击下面可查看定价，库存，交付和生命周期等信息

[>>Diodes Incorporated\(达尔科技\)](#)