

Description

The AP2120 series are positive voltage regulator ICs fabricated by CMOS process. Each of these ICs consists of a voltage reference, an error amplifier, a resistor network for setting output voltage, and a current limit circuit for current protection.

The AP2120 series feature high supply voltage ripple rejection, low dropout voltage, low noise, high output voltage accuracy, and low current consumption which make them ideal for use in various battery-powered devices.

The AP2120 series have 1.2V, 1.3V, 1.5V, 1.8V, 2.5V, 2.8V, 3.0V, 3.2V, 3.3V, 3.6V, 4.0V and 5.0V versions.

The AP2120 are available in standard SOT-23 packages.

Features

- Low Dropout Voltage at $I_{OUT} = 100\text{mA}$: 200mV Typical (Except 1.2V, 1.3V and 1.5V Versions)
- Low Quiescent Current: 25 μA Typical
- High Ripple Rejection: 65dB Typical ($f = 1\text{kHz}$)
- Output Current: More Than 150mA (250mA Limit)
- Extremely Low Noise: 15 $\mu\text{Vrms}@V_{OUT} = 1.2\text{V}, 1.3\text{V}, 1.5\text{V}$ (10Hz to 100kHz)
- Excellent Line Regulation: 4mV Typical
- Excellent Load Regulation: 12mV Typical
- High Output Voltage Accuracy: $\pm 2\%$
- Excellent Line Transient Response and Load Transient Response
- Compatible with Low ESR Ceramic Capacitor (as Low as 1 μF)
- Moisture Sensitivity: Level 1 per J-STD-020
- Terminals: Finish - Matte Tin Plated Leads, Solderable per MIL-STD-202, Method 208 [Ⓔ]
- Weight: 0.009 grams (Approximate)
- **Totally Lead-Free & Fully RoHS Compliant (Notes 1 & 2)**
- **Halogen and Antimony Free. "Green" Device (Note 3)**
- **For automotive applications requiring specific change control (i.e. parts qualified to AEC-Q100, PPAP capable, and manufactured in IATF 16949 certified facilities), please [contact us](mailto:contact@diodes.com) or your local Diodes representative. <https://www.diodes.com/quality/product-definitions/>**

Pin Assignments

(Top View)

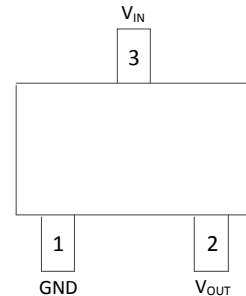

SOT-23 (N Package)

Applications

- Mobile Phones, Cordless Phones
- Wireless Communication Equipment
- Portable Games
- Cameras, Video Recorders
- Sub-Board Power Supplies for Telecom Equipment
- Battery Powered Equipment

- Notes:
1. No purposely added lead. Fully EU Directive 2002/95/EC (RoHS), 2011/65/EU (RoHS 2) & 2015/863/EU (RoHS 3) compliant.
 2. See <https://www.diodes.com/quality/lead-free/> for more information about Diodes Incorporated's definitions of Halogen- and Antimony-free, "Green" and Lead-free.
 3. Halogen- and Antimony-free "Green" products are defined as those which contain <900ppm bromine, <900ppm chlorine (<1500ppm total Br + Cl) and <1000ppm antimony compounds.

Typical Applications Circuit

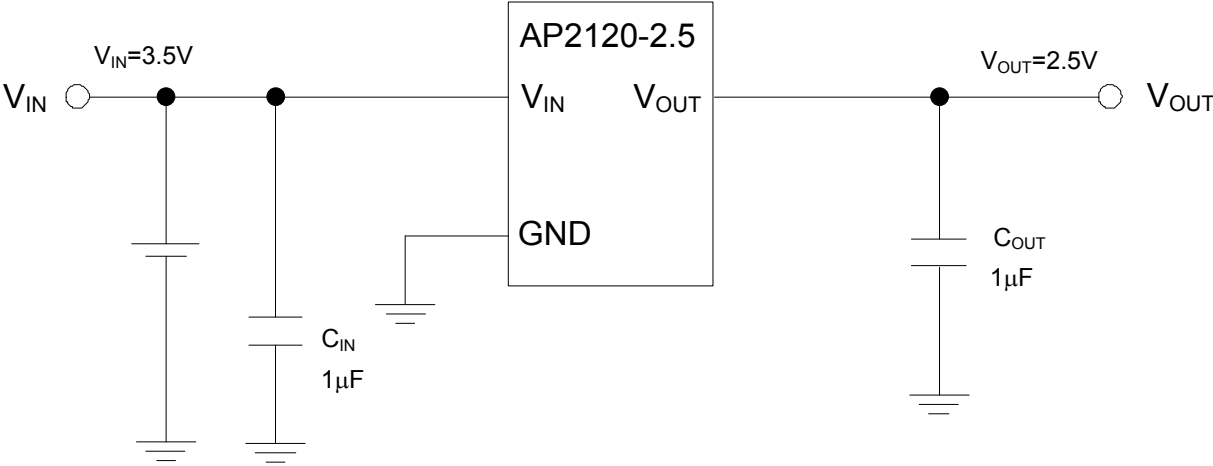

Note: Filter capacitors are required at the AP2120's input and output. 1µF capacitor is required at the input. The minimum output capacitance required for stability should be more than 1µF with ESR from 0.01Ω to 100Ω. Ceramic capacitors are recommended.

Pin Descriptions

Pin Number	Pin Name	Function
SOT-23 (N)		
1	GND	Ground
2	V _{OUT}	Regulated Output Voltage
3	V _{IN}	Input Voltage

Functional Block Diagram

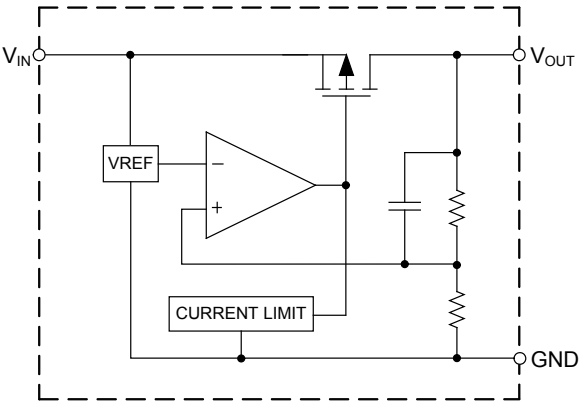

Absolute Maximum Ratings (Note 4)

Symbol	Parameter	Rating	Unit
V_{IN}	Input Voltage	6.5	V
V_{CE}	Enable Input Voltage	-0.3 to $V_{IN} + 0.3$	V
I_{OUT}	Output Current	300	mA
T_J	Junction Temperature	+150	°C
T_{STG}	Storage Temperature Range	-65 to +150	°C
T_{LEAD}	Lead Temperature (Soldering, 10s)	+260	°C
θ_{JA}	Thermal Resistance (Junction to Ambient) (Note 5)	SOT-23 250	°C/W
ESD	ESD (Human Body Model)	2000	V
ESD	ESD (Machine Model)	200	V

- Notes:
- Stresses greater than those listed under “*Absolute Maximum Ratings*” can cause permanent damage to the device. These are stress ratings only, and functional operation of the device at these or any other conditions beyond those indicated under “*Recommended Operating Conditions*” is not implied. Exposure to “*Absolute Maximum Ratings*” for extended periods can affect device reliability.
 - Absolute maximum ratings indicate limits beyond which damage to the component can occur. Electrical specifications do not apply when operating the device outside of its operating ratings. The maximum allowable power dissipation is a function of the maximum junction temperature, $T_{J(max)}$, the junction to-ambient thermal resistance, θ_{JA} , and the ambient temperature, T_A . The maximum allowable power dissipation at any ambient temperature is calculated using: $P_{D(max)} = (T_{J(max)} - T_A) / \theta_{JA}$. Exceeding the maximum allowable power dissipation will result in excessive die temperature.

Recommended Operating Conditions

Symbol	Parameter	Min	Max	Unit
V_{IN}	Input Voltage	2	6	V
T_J	Operating Junction Temperature Range	-40	+85	°C

Electrical Characteristics – AP2120-1.2

(@ $V_{IN} = 2.2V$, $T_J = +25^\circ C$, $C_{IN} = 1\mu F$, $C_{OUT} = 1\mu F$, **Bold** typeface applies over $-40^\circ C \leq T_J \leq +85^\circ C$, unless otherwise specified.)

Symbol	Parameter	Conditions	Min	Typ	Max	Unit
V_{OUT}	Output Voltage	$V_{IN} = 2.2V$ $1mA \leq I_{OUT} \leq 30mA$	1.176	1.2	1.224	V
V_{IN}	Input Voltage	—	—	—	6	V
I_{OUT}	Output Current	$V_{IN} - V_{OUT} = 1V$	150	—	—	mA
V_{RLOAD}	Load Regulation	$V_{IN} = 2.2V$ $1mA \leq I_{OUT} \leq 80mA$	—	12	40	mV
V_{RLINE}	Line Regulation	$2.2V \leq V_{IN} \leq 6V$ $I_{OUT} = 30mA$	—	4	16	mV
V_{DROP}	Dropout Voltage	$I_{OUT} = 10mA$	—	700	900	mV
		$I_{OUT} = 100mA$	—	700	900	
		$I_{OUT} = 150mA$	—	700	900	
		$I_{OUT} = 200mA$	—	700	900	
I_Q	Quiescent Current	$V_{IN} = 2.2V$, $I_{OUT} = 0mA$	—	25	50	μA
PSRR	Power Supply Rejection Ratio	Ripple 0.5Vp-p, $f = 1kHz$ $V_{IN} = 2.2V$	—	65	—	dB
$\Delta V_{OUT}/\Delta T$	Output Voltage	$I_{OUT} = 30mA$	—	± 120	—	$\mu V/^\circ C$
$(\Delta V_{OUT}/V_{OUT})/\Delta T$	Temperature Coefficient		—	± 100	—	ppm/ $^\circ C$
I_{LIMIT}	Short Current Limit	$V_{OUT} = 0V$	—	50	—	mA
V_{NOISE}	RMS Output Noise	$T_A = +25^\circ C$, $I_{OUT} = 0$ $10Hz \leq f \leq 100kHz$	—	15	—	μV_{rms}

Electrical Characteristics – AP2120-1.3

(@ $V_{IN} = 2.3V$, $T_J = +25^\circ C$, $C_{IN} = 1\mu F$, $C_{OUT} = 1\mu F$, **Bold** typeface applies over $-40^\circ C \leq T_J \leq +85^\circ C$, unless otherwise specified.)

Symbol	Parameter	Conditions	Min	Typ	Max	Unit
V_{OUT}	Output Voltage	$V_{IN} = 2.3V$ $1mA \leq I_{OUT} \leq 30mA$	1.274	1.3	1.326	V
V_{IN}	Input Voltage	—	—	—	6	V
I_{OUT}	Output Current	$V_{IN} - V_{OUT} = 1V$	150	—	—	mA
V_{RLOAD}	Load Regulation	$V_{IN} = 2.3V$ $1mA \leq I_{OUT} \leq 80mA$	—	12	40	mV
V_{RLINE}	Line Regulation	$2.3V \leq V_{IN} \leq 6V$ $I_{OUT} = 30mA$	—	4	16	mV
V_{DROP}	Dropout Voltage	$I_{OUT} = 10mA$	—	600	800	mV
		$I_{OUT} = 100mA$	—	600	800	
		$I_{OUT} = 150mA$	—	600	800	
		$I_{OUT} = 200mA$	—	600	800	
I_Q	Quiescent Current	$V_{IN} = 2.3V$, $I_{OUT} = 0mA$	—	25	50	μA
PSRR	Power Supply Rejection Ratio	Ripple 0.5Vp-p, $f = 1kHz$ $V_{IN} = 2.3V$	—	65	—	dB
$\Delta V_{OUT}/\Delta T$	Output Voltage	$I_{OUT} = 30mA$	—	± 130	—	$\mu V/^\circ C$
$(\Delta V_{OUT}/V_{OUT})/\Delta T$	Temperature Coefficient		—	± 100	—	ppm/ $^\circ C$
I_{LIMIT}	Short Current Limit	$V_{OUT} = 0V$	—	50	—	mA
V_{NOISE}	RMS Output Noise	$T_A = +25^\circ C$, $I_{OUT} = 0$ $10Hz \leq f \leq 100kHz$	—	15	—	μV_{rms}

Electrical Characteristics – AP2120-1.5

(@ $V_{IN} = 2.5V$, $T_J = +25^\circ C$, $C_{IN} = 1\mu F$, $C_{OUT} = 1\mu F$, **Bold** typeface applies over $-40^\circ C \leq T_J \leq +85^\circ C$, unless otherwise specified.)

Symbol	Parameter	Conditions	Min	Typ	Max	Unit
V_{OUT}	Output Voltage	$V_{IN} = 2.5V$ $1mA \leq I_{OUT} \leq 30mA$	1.47	1.5	1.53	V
V_{IN}	Input Voltage	—	—	—	6	V
I_{OUT}	Output Current	$V_{IN} - V_{OUT} = 1V$	150	—	—	mA
V_{RLOAD}	Load Regulation	$V_{IN} = 2.5V$ $1mA \leq I_{OUT} \leq 80mA$	—	12	40	mV
V_{RLINE}	Line Regulation	$2.3V \leq V_{IN} \leq 6V$ $I_{OUT} = 30mA$	—	4	16	mV
V_{DROP}	Dropout Voltage	$I_{OUT} = 10mA$	—	400	600	mV
		$I_{OUT} = 100mA$	—	400	600	
		$I_{OUT} = 150mA$	—	400	600	
		$I_{OUT} = 200mA$	—	400	600	
I_Q	Quiescent Current	$V_{IN} = 2.5V$, $I_{OUT} = 0mA$	—	25	50	μA
PSRR	Power Supply Rejection Ratio	Ripple 0.5Vp-p, $f = 1kHz$ $V_{IN} = 2.5V$	—	65	—	dB
$\Delta V_{OUT}/\Delta T$	Output Voltage	$I_{OUT} = 30mA$	—	± 150	—	$\mu V/^\circ C$
$(\Delta V_{OUT}/V_{OUT})/\Delta T$	Temperature Coefficient		—	± 100	—	ppm/ $^\circ C$
I_{LIMIT}	Short Current Limit	$V_{OUT} = 0V$	—	50	—	mA
V_{NOISE}	RMS Output Noise	$T_A = +25^\circ C$, $I_{OUT} = 0$ $10Hz \leq f \leq 100kHz$	—	15	—	μV_{rms}

Electrical Characteristics – AP2120-1.8

(@ $V_{IN} = 2.8V$, $T_J = +25^\circ C$, $C_{IN} = 1\mu F$, $C_{OUT} = 1\mu F$, **Bold** typeface applies over $-40^\circ C \leq T_J \leq +85^\circ C$, unless otherwise specified.)

Symbol	Parameter	Conditions	Min	Typ	Max	Unit
V_{OUT}	Output Voltage	$V_{IN} = 2.8V$ $1mA \leq I_{OUT} \leq 30mA$	1.764	1.8	1.836	V
V_{IN}	Input Voltage	—	—	—	6	V
I_{OUT}	Output Current	$V_{IN} - V_{OUT} = 1V$	150	—	—	mA
V_{RLOAD}	Load Regulation	$V_{IN} = 2.8V$ $1mA \leq I_{OUT} \leq 80mA$	—	12	40	mV
V_{RLINE}	Line Regulation	$2.3V \leq V_{IN} \leq 6V$ $I_{OUT} = 30mA$	—	4	16	mV
V_{DROP}	Dropout Voltage	$I_{OUT} = 10mA$	—	20	40	mV
		$I_{OUT} = 100mA$	—	200	300	
		$I_{OUT} = 150mA$	—	300	500	
I_Q	Quiescent Current	$V_{IN} = 2.8V$, $I_{OUT} = 0mA$	—	25	50	μA
PSRR	Power Supply Rejection Ratio	Ripple 0.5Vp-p, $f = 1kHz$ $V_{IN} = 2.8V$	—	65	—	dB
$\Delta V_{OUT}/\Delta T$	Output Voltage Temperature Coefficient	$I_{OUT} = 30mA$	—	± 180	—	$\mu V/^\circ C$
$(\Delta V_{OUT}/V_{OUT})/\Delta T$			—	± 100	—	ppm/ $^\circ C$
I_{LIMIT}	Short Current Limit	$V_{OUT} = 0V$	—	50	—	mA
V_{NOISE}	RMS Output Noise	$T_A = +25^\circ C$ $10Hz \leq f \leq 100kHz$	—	30	—	μV_{rms}

Electrical Characteristics – AP2120-2.5

 (@ $V_{IN} = 3.5V$, $T_J = +25^\circ C$, $C_{IN} = 1\mu F$, $C_{OUT} = 1\mu F$, **Bold** typeface applies over $-40^\circ C \leq T_J \leq +85^\circ C$, unless otherwise specified.)

Symbol	Parameter	Conditions	Min	Typ	Max	Unit
V_{OUT}	Output Voltage	$V_{IN} = 3.5V$ $1mA \leq I_{OUT} \leq 30mA$	2.45	2.5	2.55	V
V_{IN}	Input Voltage	—	—	—	6	V
I_{OUT}	Output Current	$V_{IN} - V_{OUT} = 1V$	150	—	—	mA
V_{RLOAD}	Load Regulation	$V_{IN} = 3.5V$ $1mA \leq I_{OUT} \leq 80mA$	—	12	40	mV
V_{RLINE}	Line Regulation	$3V \leq V_{IN} \leq 6V$ $I_{OUT} = 30mA$	—	4	16	mV
V_{DROP}	Dropout Voltage	$I_{OUT} = 10mA$	—	20	40	mV
		$I_{OUT} = 100mA$	—	200	300	
		$I_{OUT} = 150mA$	—	300	500	
I_Q	Quiescent Current	$V_{IN} = 3.5V$, $I_{OUT} = 0mA$	—	25	50	μA
PSRR	Power Supply Rejection Ratio	Ripple 0.5Vp-p, $f = 1kHz$ $V_{IN} = 3.5V$	—	65	—	dB
$\Delta V_{OUT}/\Delta T$	Output Voltage Temperature Coefficient	$I_{OUT} = 30mA$	—	± 250	—	$\mu V/^\circ C$
$(\Delta V_{OUT}/V_{OUT})/\Delta T$			—	± 100	—	ppm/ $^\circ C$
I_{LIMIT}	Short Current Limit	$V_{OUT} = 0V$	—	50	—	mA
V_{NOISE}	RMS Output Noise	$T_A = +25^\circ C$ $10Hz \leq f \leq 100kHz$	—	30	—	μV_{rms}

Electrical Characteristics – AP2120-2.8

(@ $V_{IN} = 3.8V$, $T_J = +25^\circ C$, $C_{IN} = 1\mu F$, $C_{OUT} = 1\mu F$, **Bold** typeface applies over $-40^\circ C \leq T_J \leq +85^\circ C$, unless otherwise specified.)

Symbol	Parameter	Conditions	Min	Typ	Max	Unit
V_{OUT}	Output Voltage	$V_{IN} = 3.8V$ $1mA \leq I_{OUT} \leq 30mA$	2.744	2.8	2.856	V
V_{IN}	Input Voltage	—	—	—	6	V
I_{OUT}	Output Current	$V_{IN} - V_{OUT} = 1V$	150	—	—	mA
V_{RLOAD}	Load Regulation	$V_{IN} = 3.8V$ $1mA \leq I_{OUT} \leq 80mA$	—	12	40	mV
V_{RLINE}	Line Regulation	$3.3V \leq V_{IN} \leq 6V$ $I_{OUT} = 30mA$	—	4	16	mV
V_{DROP}	Dropout Voltage	$I_{OUT} = 10mA$	—	20	40	mV
		$I_{OUT} = 100mA$	—	200	300	
		$I_{OUT} = 150mA$	—	300	500	
I_Q	Quiescent Current	$V_{IN} = 3.8V$, $I_{OUT} = 0mA$	—	25	50	μA
PSRR	Power Supply Rejection Ratio	Ripple 0.5Vp-p, $f = 1kHz$ $V_{IN} = 3.8V$	—	65	—	dB
$\Delta V_{OUT}/\Delta T$	Output Voltage Temperature Coefficient	$I_{OUT} = 30mA$	—	± 280	—	$\mu V/^\circ C$
$(\Delta V_{OUT}/V_{OUT})/\Delta T$			—	± 100	—	ppm/ $^\circ C$
I_{LIMIT}	Short Current Limit	$V_{OUT} = 0V$	—	50	—	mA
V_{NOISE}	RMS Output Noise	$T_A = +25^\circ C$ $10Hz \leq f \leq 100kHz$	—	30	—	μV_{rms}

Electrical Characteristics – AP2120-3.0

 (@ $V_{IN} = 4V$, $T_J = +25^\circ C$, $C_{IN} = 1\mu F$, $C_{OUT} = 1\mu F$, **Bold** typeface applies over $-40^\circ C \leq T_J \leq +85^\circ C$, unless otherwise specified.)

Symbol	Parameter	Conditions	Min	Typ	Max	Unit
V_{OUT}	Output Voltage	$V_{IN} = 4V$ $1mA \leq I_{OUT} \leq 30mA$	2.94	3.0	3.06	V
V_{IN}	Input Voltage	—	—	—	6	V
I_{OUT}	Output Current	$V_{IN} - V_{OUT} = 1V$	150	—	—	mA
V_{RLOAD}	Load Regulation	$V_{IN} = 4V$ $1mA \leq I_{OUT} \leq 80mA$	—	12	40	mV
V_{RLINE}	Line Regulation	$3.5V \leq V_{IN} \leq 6V$ $I_{OUT} = 30mA$	—	4	16	mV
V_{DROP}	Dropout Voltage	$I_{OUT} = 10mA$	—	20	40	mV
		$I_{OUT} = 100mA$	—	200	300	
		$I_{OUT} = 150mA$	—	300	500	
I_Q	Quiescent Current	$V_{IN} = 4V$, $I_{OUT} = 0mA$	—	25	50	μA
PSRR	Power Supply Rejection Ratio	Ripple 0.5Vp-p, $f = 1kHz$ $V_{IN} = 4V$	—	65	—	dB
$\Delta V_{OUT}/\Delta T$	Output Voltage Temperature Coefficient	$I_{OUT} = 30mA$	—	± 300	—	$\mu V/^\circ C$
$(\Delta V_{OUT}/V_{OUT})/\Delta T$			—	± 100	—	ppm/ $^\circ C$
I_{LIMIT}	Short Current Limit	$V_{OUT} = 0V$	—	50	—	mA
V_{NOISE}	RMS Output Noise	$T_A = +25^\circ C$ $10Hz \leq f \leq 100kHz$	—	30	—	μV_{rms}

Electrical Characteristics – AP2120-3.2

(@ $V_{IN} = 4.2V$, $T_J = +25^\circ C$, $C_{IN} = 1\mu F$, $C_{OUT} = 1\mu F$, **Bold** typeface applies over $-40^\circ C \leq T_J \leq +85^\circ C$, unless otherwise specified.)

Symbol	Parameter	Conditions	Min	Typ	Max	Unit
V_{OUT}	Output Voltage	$V_{IN} = 4.2V$ $1mA \leq I_{OUT} \leq 30mA$	3.136	3.2	3.264	V
V_{IN}	Input Voltage	—	—	—	6	V
I_{OUT}	Output Current	$V_{IN} - V_{OUT} = 1V$	150	—	—	mA
V_{RLOAD}	Load Regulation	$V_{IN} = 4.2V$ $1mA \leq I_{OUT} \leq 80mA$	—	12	40	mV
V_{RLINE}	Line Regulation	$3.7V \leq V_{IN} \leq 6V$ $I_{OUT} = 30mA$	—	4	16	mV
V_{DROP}	Dropout Voltage	$I_{OUT} = 10mA$	—	20	40	mV
		$I_{OUT} = 100mA$	—	200	300	
		$I_{OUT} = 150mA$	—	300	500	
I_Q	Quiescent Current	$V_{IN} = 4.2V$, $I_{OUT} = 0mA$	—	25	50	μA
PSRR	Power Supply Rejection Ratio	Ripple 0.5Vp-p, $f = 1kHz$ $V_{IN} = 4.2V$	—	65	—	dB
$\Delta V_{OUT}/\Delta T$	Output Voltage Temperature Coefficient	$I_{OUT} = 30mA$	—	± 320	—	$\mu V/^\circ C$
$(\Delta V_{OUT}/V_{OUT})/\Delta T$			—	± 100	—	ppm/ $^\circ C$
I_{LIMIT}	Short Current Limit	$V_{OUT} = 0V$	—	50	—	mA
V_{NOISE}	RMS Output Noise	$T_A = +25^\circ C$ $10Hz \leq f \leq 100kHz$	—	30	—	μV_{rms}

Electrical Characteristics – AP2120-3.3

(@ $V_{IN} = 4.3V$, $T_J = +25^\circ C$, $C_{IN} = 1\mu F$, $C_{OUT} = 1\mu F$, **Bold** typeface applies over $-40^\circ C \leq T_J \leq +85^\circ C$, unless otherwise specified.)

Symbol	Parameter	Conditions	Min	Typ	Max	Unit
V_{OUT}	Output Voltage	$V_{IN} = 4.3V$ $1mA \leq I_{OUT} \leq 30mA$	3.234	3.3	3.366	V
V_{IN}	Input Voltage	—	—	—	6	V
I_{OUT}	Output Current	$V_{IN} - V_{OUT} = 1V$	150	—	—	mA
V_{RLOAD}	Load Regulation	$V_{IN} = 4.3V$ $1mA \leq I_{OUT} \leq 80mA$	—	12	40	mV
V_{RLINE}	Line Regulation	$3.8V \leq V_{IN} \leq 6V$ $I_{OUT} = 30mA$	—	4	16	mV
V_{DROP}	Dropout Voltage	$I_{OUT} = 10mA$	—	20	40	mV
		$I_{OUT} = 100mA$	—	200	300	
		$I_{OUT} = 150mA$	—	300	500	
I_Q	Quiescent Current	$V_{IN} = 4.3V$, $I_{OUT} = 0mA$	—	25	50	μA
PSRR	Power Supply Rejection Ratio	Ripple 0.5Vp-p, $f = 1kHz$ $V_{IN} = 4.3V$	—	65	—	dB
$\Delta V_{OUT}/\Delta T$	Output Voltage Temperature Coefficient	$I_{OUT} = 30mA$	—	± 330	—	$\mu V/^\circ C$
$(\Delta V_{OUT}/V_{OUT})/\Delta T$			—	± 100	—	ppm/ $^\circ C$
I_{LIMIT}	Short Current Limit	$V_{OUT} = 0V$	—	50	—	mA
V_{NOISE}	RMS Output Noise	$T_A = +25^\circ C$ $10Hz \leq f \leq 100kHz$	—	30	—	μV_{rms}

Electrical Characteristics – AP2120-5.0

(@ $V_{IN} = 6.0V$, $T_J = +25^\circ C$, $C_{IN} = 1\mu F$, $C_{OUT} = 1\mu F$, **Bold** typeface applies over $-40^\circ C \leq T_J \leq +85^\circ C$, unless otherwise specified.)

Symbol	Parameter	Conditions	Min	Typ	Max	Unit
V_{OUT}	Output Voltage	$V_{IN} = 6.0V$ $1mA \leq I_{OUT} \leq 30mA$	4.9	5.0	5.1	V
V_{IN}	Input Voltage	—	—	—	6	V
I_{OUT}	Output Current	$V_{IN} - V_{OUT} = 1V$	150	—	—	mA
V_{RLOAD}	Load Regulation	$V_{IN} = 4.3V$ $1mA \leq I_{OUT} \leq 80mA$	—	12	40	mV
V_{RLINE}	Line Regulation	$5.5V \leq V_{IN} \leq 6V$ $I_{OUT} = 30mA$	—	4	16	mV
V_{DROP}	Dropout Voltage	$I_{OUT} = 10mA$	—	20	40	mV
		$I_{OUT} = 100mA$	—	200	300	
		$I_{OUT} = 150mA$	—	300	500	
I_Q	Quiescent Current	$V_{IN} = 6.0V$, $I_{OUT} = 0mA$	—	25	50	μA
PSRR	Power Supply Rejection Ratio	Ripple 0.5Vp-p, $f = 1kHz$ $V_{IN} = 6.0V$	—	65	—	dB
$\Delta V_{OUT}/\Delta T$	Output Voltage Temperature Coefficient	$I_{OUT} = 30mA$	—	± 330	—	$\mu V/^\circ C$
$(\Delta V_{OUT}/V_{OUT})/\Delta T$			—	± 100	—	ppm/ $^\circ C$
I_{LIMIT}	Short Current Limit	$V_{OUT} = 0V$	—	50	—	mA
V_{NOISE}	RMS Output Noise	$T_A = +25^\circ C$ $10Hz \leq f \leq 100kHz$	—	30	—	μV_{rms}

Performance Characteristics

Output Voltage vs. Output Current

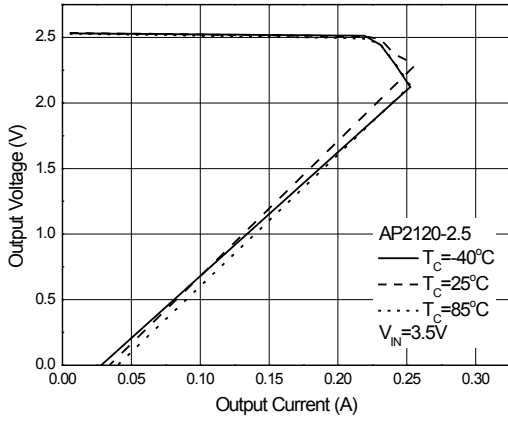

Output Voltage vs. Case Temperature

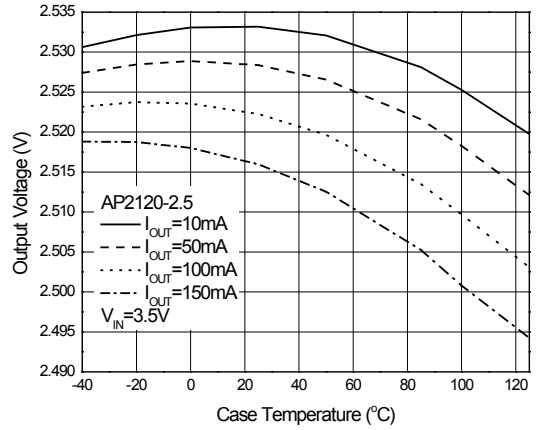

Quiescent Current vs. Input Voltage

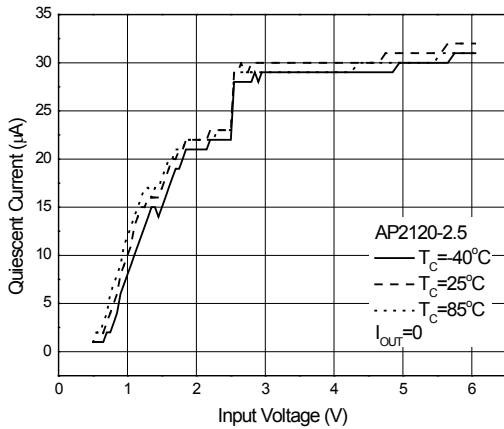

Quiescent Current vs. Output Current

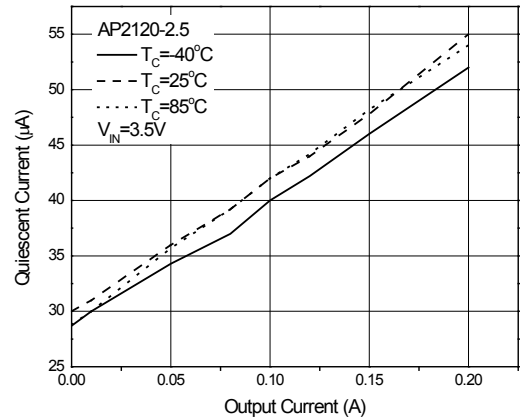

Quiescent Current vs. Case Temperature

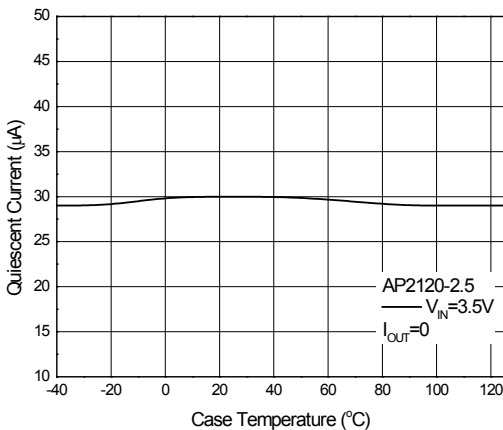

Dropout Voltage vs. Output Current

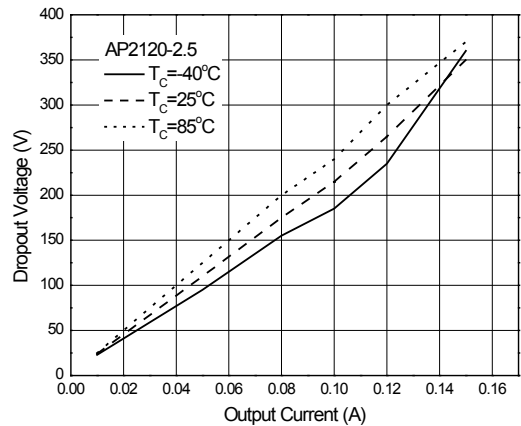

Performance Characteristics (continued)

Dropout Voltage vs. Case Temperature

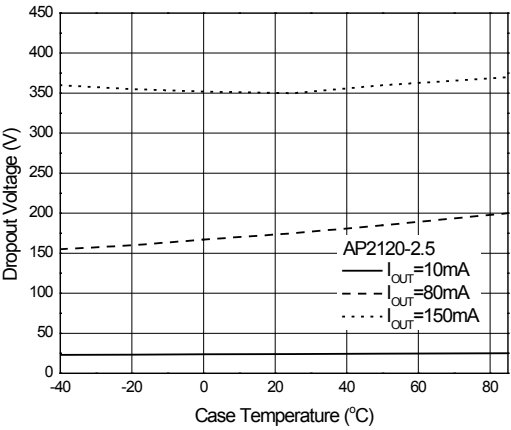

Load Transient ($I_{OUT}=0$ to 150mA)

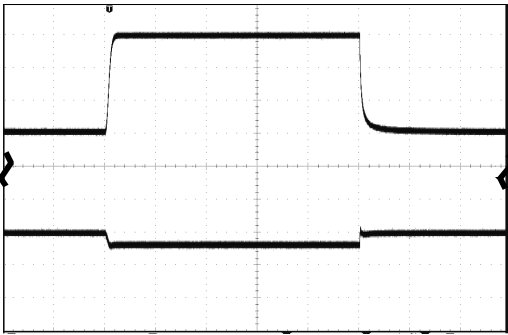

Line Transient (Condition: $V_{IN}=2.5\text{V}$ to 3.5V , $I_{OUT}=10\text{mA}$)

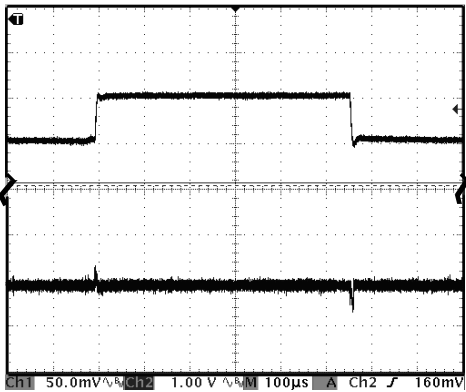

PSRR vs. Frequency

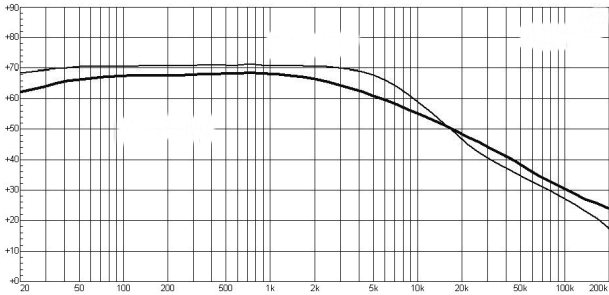

Start-up

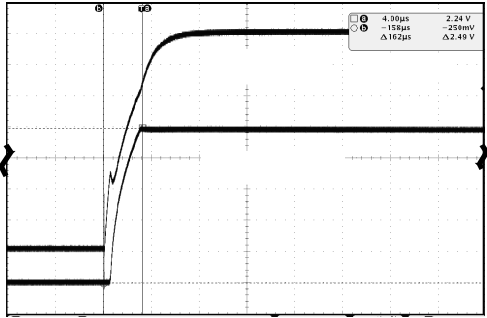

Ordering Information

Package	Temperature Range	Output Voltage	Part Number	Marking ID	Packing
SOT-23	-40 to +85°C	1.2V(N)	AP2120N-1.2TRG1	GR4	3000/Tape & Reel
		1.3V(N) (NRND) (Note 6)	AP2120N-1.3TRG1	GR5	3000/Tape & Reel
		1.5V(N)	AP2120N-1.5TRG1	GR6	3000/Tape & Reel
		1.8V(N)	AP2120N-1.8TRG1	GR7	3000/Tape & Reel
		2.5V(N)	AP2120N-2.5TRG1	GR8	3000/Tape & Reel
		2.8V(N) (NRND) (Note 6)	AP2120N-2.8TRG1	GR9	3000/Tape & Reel
		3.0V(N)	AP2120N-3.0TRG1	GS2	3000/Tape & Reel
		3.2V(N)	AP2120N-3.2TRG1	GS3	3000/Tape & Reel
		3.3V(N)	AP2120N-3.3TRG1	GS4	3000/Tape & Reel
		5.0V(N)	AP2120N-5.0TRG1	GS5	3000/Tape & Reel

Note: 6. NRND: Not Recommended for New Design.

Marking Information

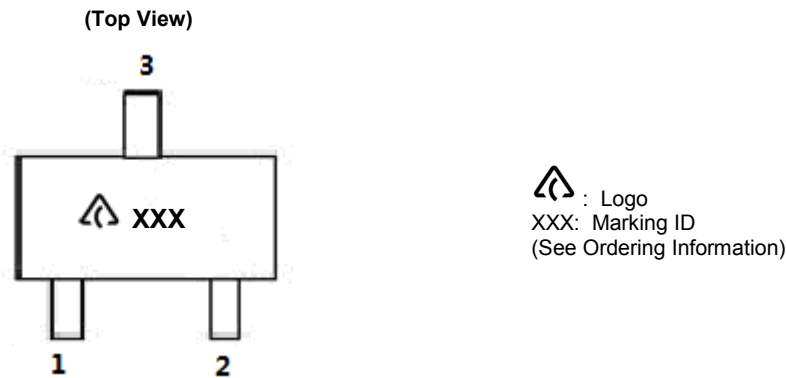

Package Outline Dimensions (All dimensions in mm(inch).)

Please see <http://www.diodes.com/package-outlines.html> for the latest version.

SOT-23

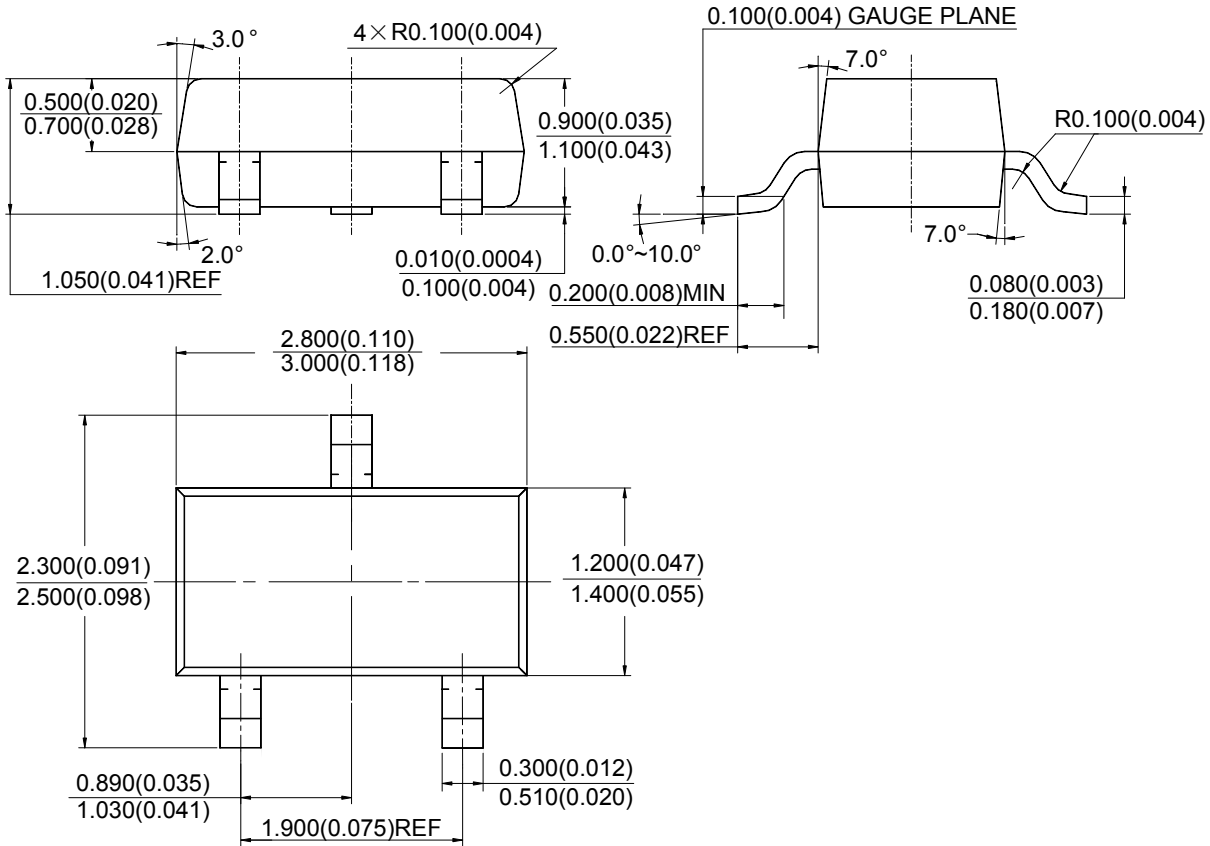

Suggested Pad Layout

Please see <http://www.diodes.com/package-outlines.html> for the latest version.

SOT-23

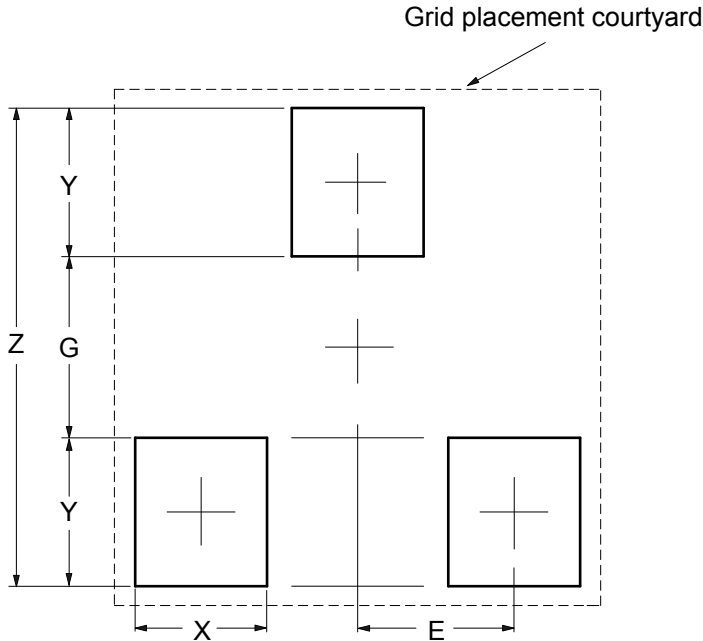

Dimensions	Z (mm)/(inch)	G (mm)/(inch)	X (mm)/(inch)	Y (mm)/(inch)	E (mm)/(inch)
Value	2.900/0.114	1.100/0.043	0.800/0.031	0.900/0.035	0.950/0.037

IMPORTANT NOTICE

1. DIODES INCORPORATED AND ITS SUBSIDIARIES (“DIODES”) MAKE NO WARRANTY OF ANY KIND, EXPRESS OR IMPLIED, WITH REGARDS TO ANY INFORMATION CONTAINED IN THIS DOCUMENT, INCLUDING, BUT NOT LIMITED TO, THE IMPLIED WARRANTIES OF MERCHANTABILITY, FITNESS FOR A PARTICULAR PURPOSE OR NON-INFRINGEMENT OF THIRD PARTY INTELLECTUAL PROPERTY RIGHTS (AND THEIR EQUIVALENTS UNDER THE LAWS OF ANY JURISDICTION).
2. The Information contained herein is for informational purpose only and is provided only to illustrate the operation of Diodes products described herein and application examples. Diodes does not assume any liability arising out of the application or use of this document or any product described herein. This document is intended for skilled and technically trained engineering customers and users who design with Diodes products. Diodes products may be used to facilitate safety-related applications; however, in all instances customers and users are responsible for (a) selecting the appropriate Diodes products for their applications, (b) evaluating the suitability of the Diodes products for their intended applications, (c) ensuring their applications, which incorporate Diodes products, comply the applicable legal and regulatory requirements as well as safety and functional-safety related standards, and (d) ensuring they design with appropriate safeguards (including testing, validation, quality control techniques, redundancy, malfunction prevention, and appropriate treatment for aging degradation) to minimize the risks associated with their applications.
3. Diodes assumes no liability for any application-related information, support, assistance or feedback that may be provided by Diodes from time to time. Any customer or user of this document or products described herein will assume all risks and liabilities associated with such use, and will hold Diodes and all companies whose products are represented herein or on Diodes’ websites, harmless against all damages and liabilities.
4. Products described herein may be covered by one or more United States, international or foreign patents and pending patent applications. Product names and markings noted herein may also be covered by one or more United States, international or foreign trademarks and trademark applications. Diodes does not convey any license under any of its intellectual property rights or the rights of any third parties (including third parties whose products and services may be described in this document or on Diodes’ website) under this document.
5. Diodes products are provided subject to Diodes’ Standard Terms and Conditions of Sale (<https://www.diodes.com/about/company/terms-and-conditions/terms-and-conditions-of-sales/>) or other applicable terms. This document does not alter or expand the applicable warranties provided by Diodes. Diodes does not warrant or accept any liability whatsoever in respect of any products purchased through unauthorized sales channel.
6. Diodes products and technology may not be used for or incorporated into any products or systems whose manufacture, use or sale is prohibited under any applicable laws and regulations. Should customers or users use Diodes products in contravention of any applicable laws or regulations, or for any unintended or unauthorized application, customers and users will (a) be solely responsible for any damages, losses or penalties arising in connection therewith or as a result thereof, and (b) indemnify and hold Diodes and its representatives and agents harmless against any and all claims, damages, expenses, and attorney fees arising out of, directly or indirectly, any claim relating to any noncompliance with the applicable laws and regulations, as well as any unintended or unauthorized application.
7. While efforts have been made to ensure the information contained in this document is accurate, complete and current, it may contain technical inaccuracies, omissions and typographical errors. Diodes does not warrant that information contained in this document is error-free and Diodes is under no obligation to update or otherwise correct this information. Notwithstanding the foregoing, Diodes reserves the right to make modifications, enhancements, improvements, corrections or other changes without further notice to this document and any product described herein. This document is written in English but may be translated into multiple languages for reference. Only the English version of this document is the final and determinative format released by Diodes.
8. Any unauthorized copying, modification, distribution, transmission, display or other use of this document (or any portion hereof) is prohibited. Diodes assumes no responsibility for any losses incurred by the customers or users or any third parties arising from any such unauthorized use.

Copyright © 2021 Diodes Incorporated

www.diodes.com

单击下面可查看定价，库存，交付和生命周期等信息

[>>Diodes Incorporated\(达达科技\(美台\)\)](#)