

Features

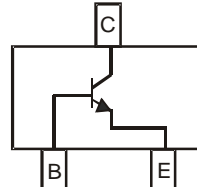
- Ideal for Medium Power Amplification and Switching
- Complementary PNP Type Available (DSS20200L)
- Ultra Low Collector-Emitter Saturation Voltage
- **Lead Free By Design/RoHS Compliant (Note 1)**
- **"Green" Device (Note 2)**

Mechanical Data

- Case: SOT-23
- Case Material: Molded Plastic, "Green" Molding Compound. UL Flammability Classification Rating 94V-0
- Moisture Sensitivity: Level 1 per J-STD-020D
- Terminals: Finish — Matte Tin annealed over Copper leadframe. Solderable per MIL-STD-202, Method 208
- Marking Information: See Page 4
- Ordering Information: See Page 4
- Weight: 0.008 grams (approximate)



Top View



Device Schematic

Maximum Ratings @ $T_A = 25^\circ\text{C}$ unless otherwise specified

Characteristic	Symbol	Value	Unit
Collector-Base Voltage	V_{CBO}	20	V
Collector-Emitter Voltage	V_{CEO}	20	V
Emitter-Base Voltage	V_{EBO}	6	V
Peak Pulse Current	I_{CM}	4	A
Continuous Collector Current	I_C	2	A

Thermal Characteristics

Characteristic	Symbol	Value	Unit
Power Dissipation (Note 3) @ $T_A = 25^\circ\text{C}$	P_D	600	mW
Thermal Resistance, Junction to Ambient Air (Note 3) @ $T_A = 25^\circ\text{C}$	$R_{\theta JA}$	209	$^\circ\text{C/W}$
Power Dissipation (Note 4) @ $T_A = 25^\circ\text{C}$	P_D	1.2	mW
Thermal Resistance, Junction to Ambient Air (Note 4) @ $T_A = 25^\circ\text{C}$	$R_{\theta JA}$	104	$^\circ\text{C/W}$
Operating and Storage Temperature Range	T_J, T_{STG}	-55 to +150	$^\circ\text{C}$

- Notes:
1. No purposefully added lead.
 2. Diodes Inc.'s "Green" policy can be found on our website at http://www.diodes.com/products/lead_free/index.php.
 3. Device mounted on FR-4 PCB with minimum recommended pad layout.
 4. Device mounted on FR-4 PCB with 1 inch² copper pad layout.

Electrical Characteristics @ $T_A = 25^\circ\text{C}$ unless otherwise specified

Characteristic	Symbol	Min	Typ	Max	Unit	Test Conditions
OFF CHARACTERISTICS						
Collector-Base Breakdown Voltage	$V_{(BR)CBO}$	20	—	—	V	$I_C = 100\mu\text{A}$
Collector-Emitter Breakdown Voltage (Note 5)	$V_{(BR)CEO}$	20	—	—	V	$I_C = 10\text{mA}$
Emitter-Base Breakdown Voltage	$V_{(BR)EBO}$	6	—	—	V	$I_E = 100\mu\text{A}$
Collector-Base Cutoff Current	I_{CBO}	—	—	100	nA	$V_{CB} = 20\text{V}, I_E = 0$
Emitter-Base Cutoff Current	I_{EBO}	—	—	100	nA	$V_{EB} = 6\text{V}, I_C = 0$
ON CHARACTERISTICS (Note 5)						
DC Current Gain	h_{FE}	200	—	—	—	$V_{CE} = 2\text{V}, I_C = 10\text{mA}$
		200	330	—		$V_{CE} = 2\text{V}, I_C = 500\text{mA}$
		200	—	—		$V_{CE} = 2\text{V}, I_C = 1\text{A}$
		200	—	—		$V_{CE} = 2\text{V}, I_C = 2\text{A}$
Collector-Emitter Saturation Voltage	$V_{CE(SAT)}$	—	—	10	mV	$I_C = 0.1\text{A}, I_B = 10\text{mA}$
		—	40	50		$I_C = 1.0\text{A}, I_B = 100\text{mA}$
		—	75	90		$I_C = 1.0\text{A}, I_B = 10\text{mA}$
		—	70	100		$I_C = 2.0\text{A}, I_B = 200\text{mA}$
Equivalent On-Resistance	$R_{CE(SAT)}$	—	35	50	m Ω	$I_E = 2\text{A}, I_B = 200\text{mA}$
Base-Emitter Saturation Voltage	$V_{BE(SAT)}$	—	—	0.9	V	$I_C = 1\text{A}, I_B = 10\text{mA}$
Base-Emitter Turn-on Voltage	$V_{BE(ON)}$	—	—	0.9	V	$V_{CE} = 2\text{V}, I_C = 1\text{A}$
SMALL SIGNAL CHARACTERISTICS						
Transition Frequency	f_T	150	—	—	MHz	$V_{CE} = 5\text{V}, I_C = 100\text{mA}, f = 100\text{MHz}$
Output Capacitance	C_{obo}	—	—	45	pF	$V_{CB} = 3\text{V}, f = 1\text{MHz}$
Input Capacitance	C_{ibo}	—	—	450	pF	$V_{EB} = 0.5\text{V}, f = 1\text{MHz}$
SWITCHING CHARACTERISTICS						
Turn-On Time	t_{on}	—	—	200	ns	$V_{CC} = 15\text{V}, I_C = 750\text{mA}, I_{B1} = 15\text{mA}$
Delay Time	t_d	—	—	100	ns	
Rise Time	t_r	—	—	100	ns	
Turn-Off Time	t_{off}	—	—	610	ns	$V_{CC} = 15\text{V}, I_C = 750\text{mA}, I_{B1} = I_{B2} = 15\text{mA}$
Storage Time	t_s	—	—	500	ns	
Fall Time	t_f	—	—	110	ns	

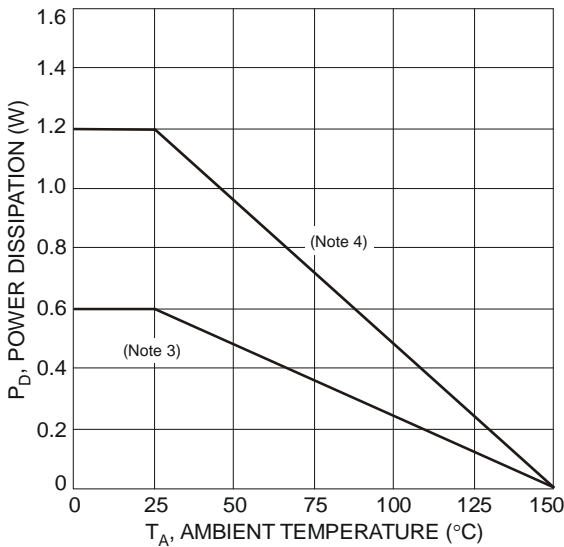
 Notes: 5. Measured under pulsed conditions. Pulse width = 300 μs . Duty cycle $\leq 2\%$.


Fig. 1 Power Dissipation vs. Ambient Temperature

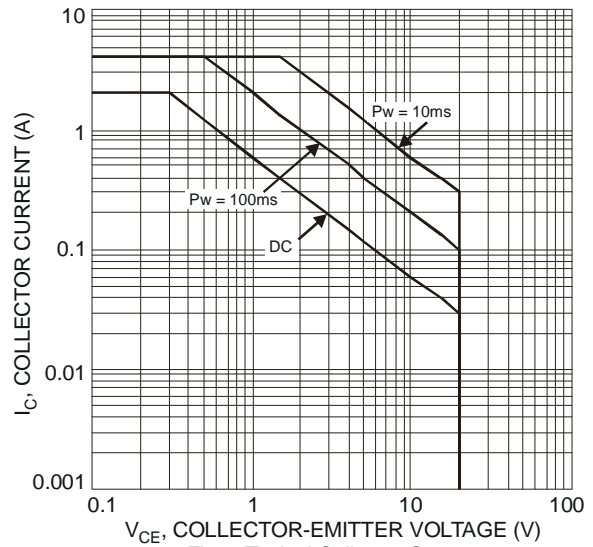


Fig. 2 Typical Collector Current vs. Collector-Emitter Voltage

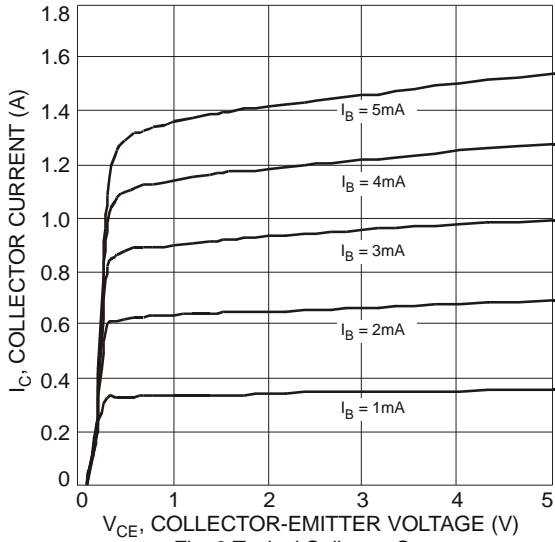


Fig. 3 Typical Collector Current vs. Collector-Emitter Voltage

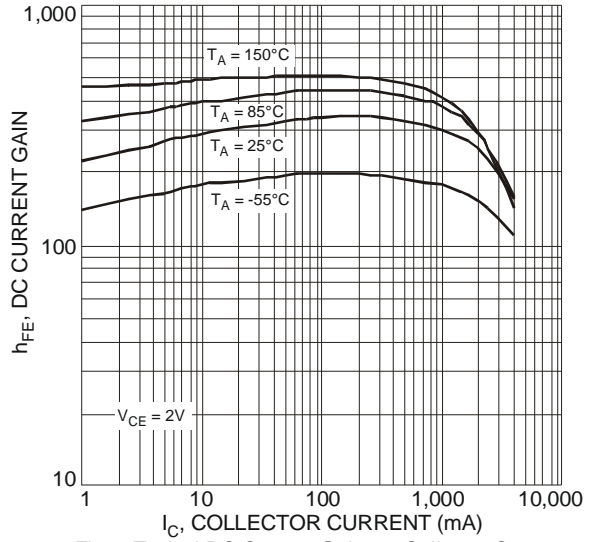


Fig. 4 Typical DC Current Gain vs. Collector Current

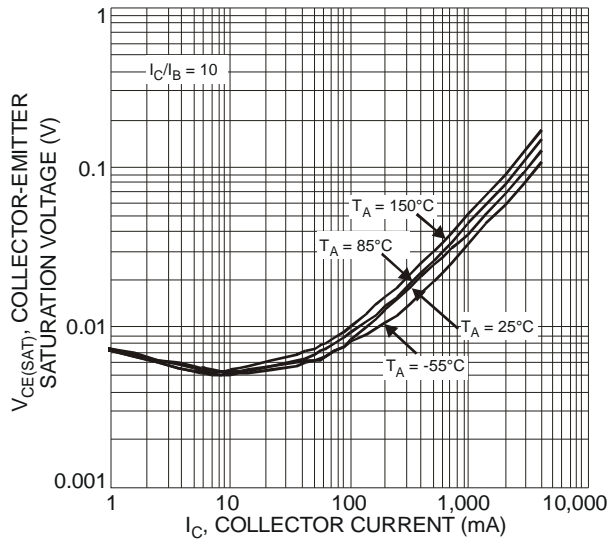


Fig. 5 Typical Collector-Emitter Saturation Voltage vs. Collector Current

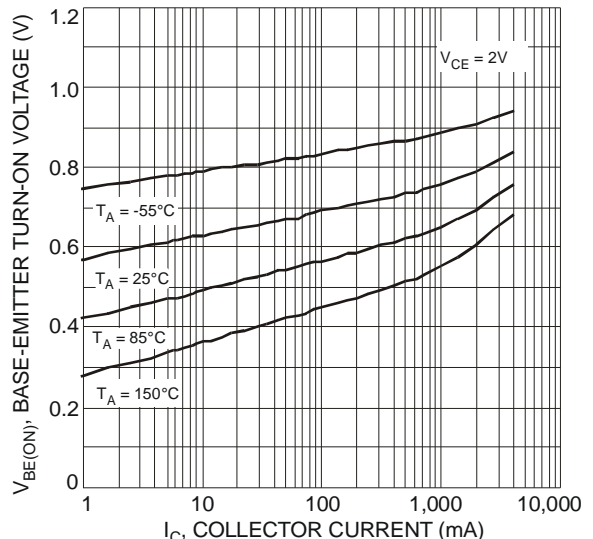


Fig. 6 Typical Base-Emitter Turn-On Voltage vs. Collector Current

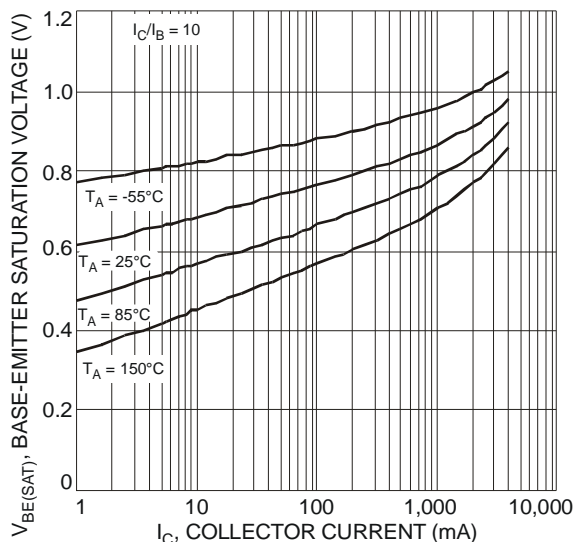


Fig. 7 Typical Base-Emitter Saturation Voltage vs. Collector Current

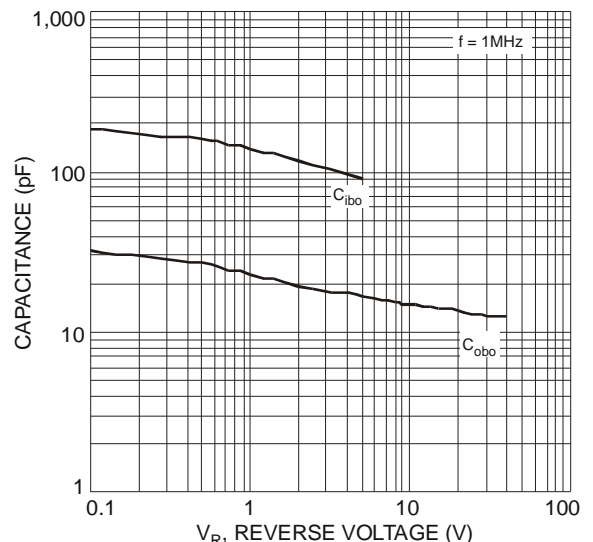


Fig. 8 Typical Capacitance Characteristics

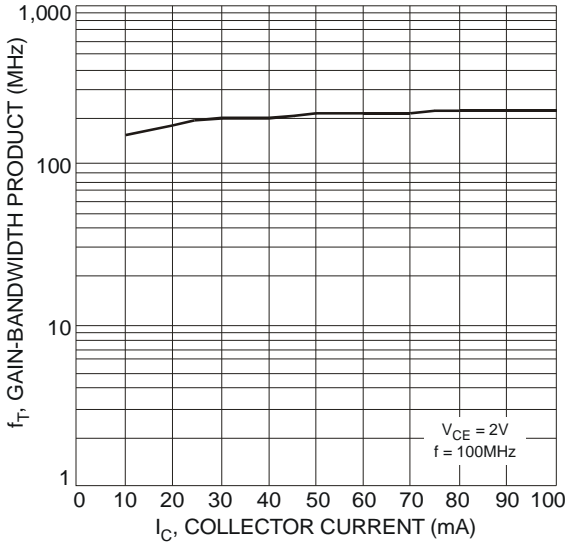


Fig. 9 Typical Gain-Bandwidth Product vs. Collector Current

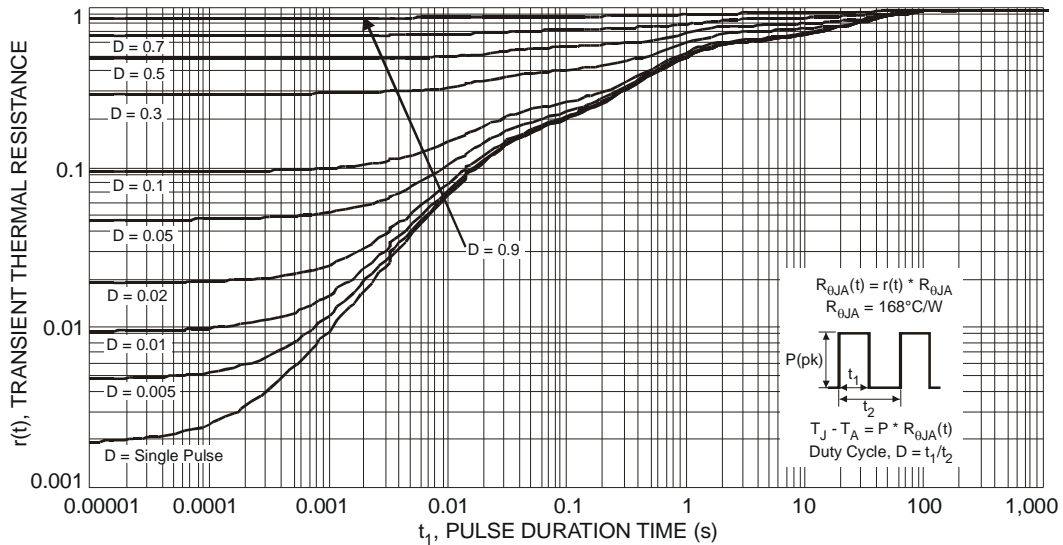


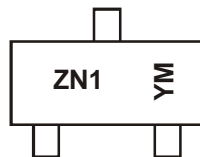
Fig. 10 Transient Thermal Response

Ordering Information (Note 6)

Part Number	Case	Packaging
DSS20201L-7	SOT-23	3000/Tape & Reel

Notes: 6. For packaging details, go to our website at <http://www.diodes.com/datasheets/ap02007.pdf>.

Marking Information



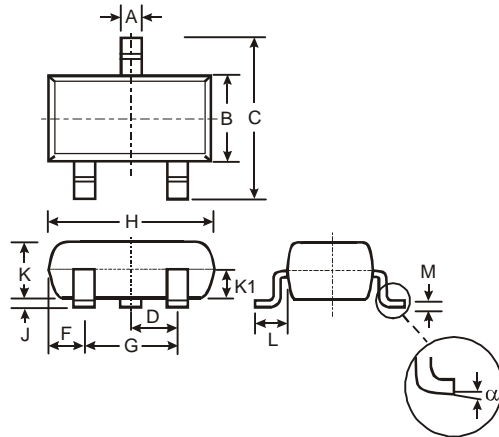
ZN1 = Product Type Marking Code
 YM = Date Code Marking
 Y = Year (ex: V = 2008)
 M = Month (ex: 9 = September)

Date Code Key

Year	2008	2009	2010	2011	2012	2013	2014	2015
Code	V	W	X	Y	Z	A	B	C

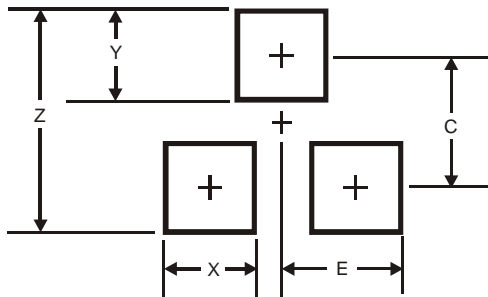
Month	Jan	Feb	Mar	Apr	May	Jun	Jul	Aug	Sep	Oct	Nov	Dec
Code	1	2	3	4	5	6	7	8	9	O	N	D

Package Outline Dimensions



SOT-23			
Dim	Min	Max	Typ
A	0.37	0.51	0.40
B	1.20	1.40	1.30
C	2.30	2.50	2.40
D	0.89	1.03	0.915
F	0.45	0.60	0.535
G	1.78	2.05	1.83
H	2.80	3.00	2.90
J	0.013	0.10	0.05
K	0.903	1.10	1.00
K1	-	-	0.400
L	0.45	0.61	0.55
M	0.085	0.18	0.11
α	0°	8°	-
All Dimensions in mm			

Suggested Pad Layout



Dimensions	Value (in mm)
Z	2.9
X	0.8
Y	0.9
C	2.0
E	1.35

IMPORTANT NOTICE

Diodes Incorporated and its subsidiaries reserve the right to make modifications, enhancements, improvements, corrections or other changes without further notice to any product herein. Diodes Incorporated does not assume any liability arising out of the application or use of any product described herein; neither does it convey any license under its patent rights, nor the rights of others. The user of products in such applications shall assume all risks of such use and will agree to hold Diodes Incorporated and all the companies whose products are represented on our website, harmless against all damages.

LIFE SUPPORT

Diodes Incorporated products are not authorized for use as critical components in life support devices or systems without the expressed written approval of the President of Diodes Incorporated.

单击下面可查看定价，库存，交付和生命周期等信息

[>>Diodes Incorporated\(达尔科技\)](#)