

**60V N-CHANNEL SELF PROTECTED ENHANCEMENT MODE  
INTELLIFET® MOSFET**

### Product Summary

- Continuous Drain Source Voltage  $V_{DS} = 60V$
- On-State Resistance 500mΩ
- Nominal Load Current ( $V_{IN} = 5V$ ) 1.2A
- Clamping Energy 210mJ

### Description

The ZXMS6004DT8Q is a dual self protected low side MOSFET with logic level input. It integrates over-temperature, over-current, over-voltage (active clamp) and ESD protected logic level functionality. The ZXMS6004DT8Q is ideal as a general purpose switch driven from 3.3V or 5V microcontrollers in harsh environments where standard MOSFETs are not rugged enough.

### Applications

- Two completely isolated independent channels
- Especially suited for loads with a high in-rush current such as lamps and motors
- All types of resistive, inductive and capacitive loads in switching applications
- $\mu C$  compatible power switch for 12V and 24V DC applications.
- Automotive rated
- Replaces electromechanical relays and discrete circuits
- Linear Mode capability - the current-limiting protection circuitry is designed to de-activate at low  $V_{DS}$  to minimise on state power dissipation. The maximum DC operating current is therefore determined by the thermal capability of the package/board combination, rather than by the protection circuitry. This does not compromise the product's ability to self-protect at low  $V_{DS}$ .

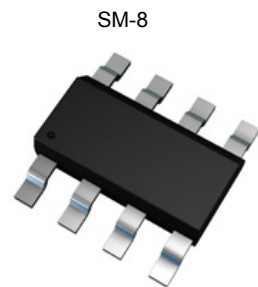

Top View

### Features and Benefits

- Compact Dual Package
- Low Input Current
- Logic Level Input (3.3V and 5V)
- Short Circuit Protection with Auto Restart
- Over Voltage Protection (active clamp)
- Thermal Shutdown with Auto Restart
- Over-Current Protection
- Input Protection (ESD)
- High Continuous Current Rating
- **Qualified to AEC-Q101 Standards for High Reliability**
- **PPAP Capable**
- **Lead-Free Finish; RoHS compliant (Note 1 & 2)**
- **Halogen and Antimony Free. "Green" Device (Note 3)**

### Mechanical Data

- Case: SM-8
- Case Material: Molded Plastic, "Green" Molding Compound  
UL Flammability Classification Rating 94V-0
- Moisture Sensitivity: Level 1 per J-STD-020
- Terminals: Matte Tin Finish
- Weight: 0.117 grams (approximate)

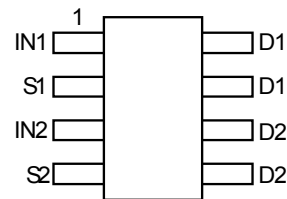

Top view  
Pin-Out

### Ordering Information

Product	Marking	Reel size (inches)	Tape width (mm)	Quantity per reel
ZXMS6004DT8QTA	ZXMS6004D	7	12	1,000 units

- Notes:
1. EU Directive 2002/95/EC (RoHS) & 2011/65/EU (RoHS 2) compliant. All applicable RoHS exemptions applied.
  2. See [http://www.diodes.com/quality/lead\\_free.html](http://www.diodes.com/quality/lead_free.html) for more information about Diodes Incorporated's definitions of Halogen- and Antimony-free, "Green" and Lead-free.
  3. Halogen- and Antimony-free "Green" products are defined as those which contain <900ppm bromine, <900ppm chlorine (<1500ppm total Br + Cl) and <1000ppm antimony compounds.
  4. Automotive products are AEC-Q101 qualified and are PPAP capable. Automotive, AEC-Q101 and standard products are electrically and thermally the same, except where specified. For more information, please refer to [http://www.diodes.com/quality/product\\_compliance\\_definitions/](http://www.diodes.com/quality/product_compliance_definitions/).
  5. For packaging details, go to our website at <http://www.diodes.com/products/packages.html>.

**Marking Information**

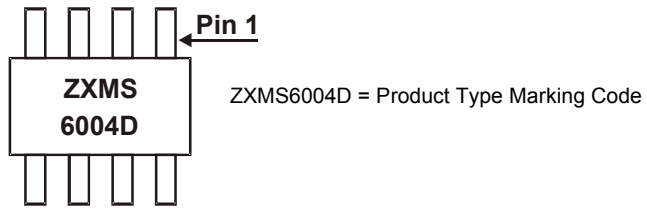

**Functional Block Diagram**

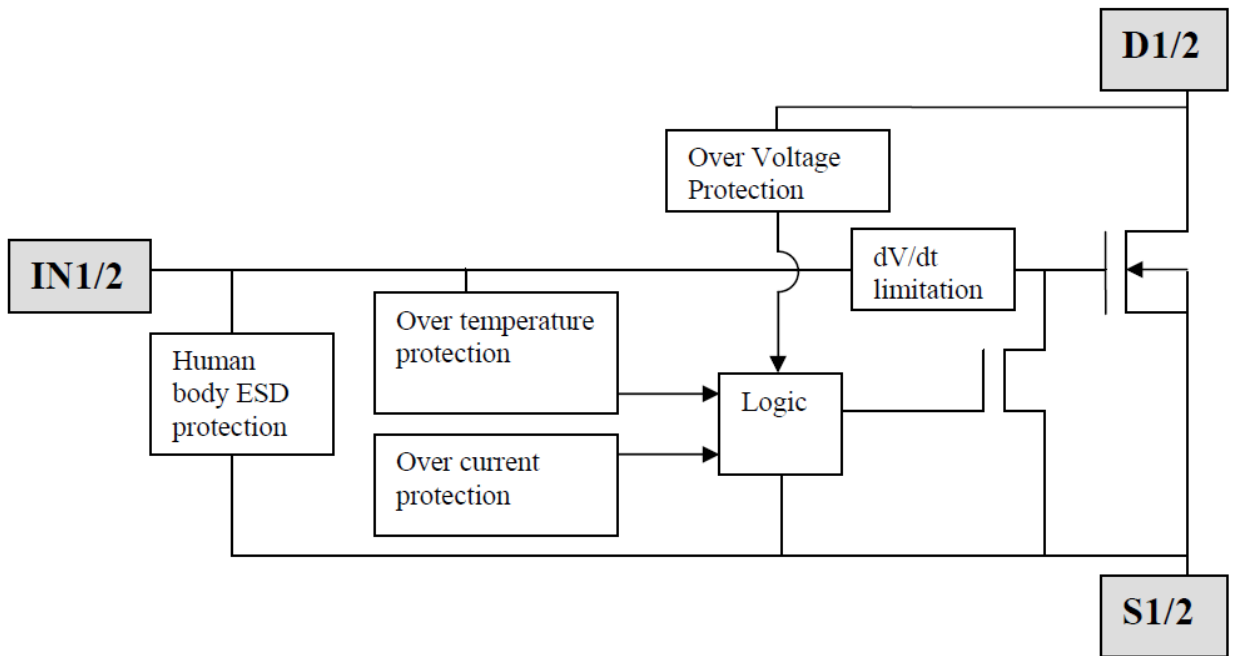

**Absolute Maximum Ratings** (@T<sub>amb</sub> = +25°C, unless otherwise stated.)

Characteristic	Symbol	Value	Units
Continuous Drain-Source Voltage	V <sub>DS</sub>	60	V
Drain-Source Voltage For Short Circuit Protection	V <sub>DS(SC)</sub>	36	V
Continuous Input Voltage	V <sub>IN</sub>	-0.5 ... +6	V
Continuous Input Current @ -0.2V ≤ V <sub>IN</sub> ≤ 6V	I <sub>IN</sub>	No limit   I <sub>IN</sub>   ≤ 2	mA
Continuous Input Current @ V <sub>IN</sub> < -0.2V or V <sub>IN</sub> > 6V			
Pulsed Drain Current @ V <sub>IN</sub> = 3.3V (Note 8)	I <sub>DM</sub>	2	A
Pulsed Drain Current @ V <sub>IN</sub> = 5V (Note 8)	I <sub>DM</sub>	2.5	A
Continuous Source Current (Body Diode) (Note 6)	I <sub>S</sub>	1	A
Pulsed Source Current (Body Diode) (Note 8)	I <sub>SM</sub>	5	A
Unclamped Single Pulse Inductive Energy, T <sub>J</sub> = +25°C, I <sub>D</sub> = 0.5A, V <sub>DD</sub> = 24V	E <sub>AS</sub>	210	mJ
Electrostatic Discharge (Human Body Model)	V <sub>ESD</sub>	4000	V
Charged Device Model	V <sub>CDM</sub>	1000	V

**Thermal Resistance**

Characteristic	Symbol	Value	Units
Power Dissipation at T <sub>amb</sub> = +25°C (Notes 6 & 9)	P <sub>D</sub>	1.16	W
Linear Derating Factor		9.28	mW/°C
Power Dissipation at T <sub>amb</sub> = +25°C (Notes 6 & 10)	P <sub>D</sub>	1.67	W
Linear Derating Factor		13.3	mW/°C
Power Dissipation at T <sub>amb</sub> = +25°C (Notes 7 & 9)	P <sub>D</sub>	2.13	W
Linear Derating Factor		17	mW/°C
Thermal Resistance, Junction to Ambient (Notes 6 & 9)	R <sub>θJA</sub>	108	°C/W
Thermal Resistance, Junction to Ambient (Notes 6 & 10)	R <sub>θJA</sub>	75	°C/W
Thermal Resistance, Junction to Case (Notes 7 & 9)	R <sub>θJC</sub>	58.7	°C/W
Thermal Resistance, Junction to Case (Note 11)	R <sub>θJC</sub>	26.5	°C/W
Operating Temperature Range	T <sub>J</sub>	-40 to +150	°C
Storage Temperature Range	T <sub>STG</sub>	-55 to +150	°C

- Notes:
6. For a dual device surface mounted on a 25mm x 25mm FR4 PCB single sided 1oz weight copper split down the middle on 1.6mm FR4 board, in still air conditions
  7. For a dual device surface mounted on FR4 PCB measured at t ≤ 10sec
  8. Repetitive rating 25mm x 25mm FR4 PCB, D = 0.02 pulse width = 300µs – pulse width limited by junction temperature. Refer to transient Thermal Impedance Graph
  9. For a dual device with one active die
  10. For dual device with 2 active die running at equal power
  11. Thermal resistance from junction to solder-point (at the end of the drain lead)

**Recommended Operating Conditions**

The ZXMS6004DT8Q is optimized for use with µC operating from 3.3V and 5V supplies.

Characteristic	Symbol	Min	Max	Unit
Input Voltage Range	V <sub>IN</sub>	0	5.5	V
Ambient Temperature Range	T <sub>A</sub>	-40	125	°C
High Level Input Voltage for MOSFET to be on	V <sub>IH</sub>	3	5.5	V
Low Level Input Voltage for MOSFET to be off	V <sub>IL</sub>	0	0.7	V
Peripheral Supply Voltage (Voltage to Which Load is Referred)	V <sub>P</sub>	0	36	V

**Thermal Characteristics**

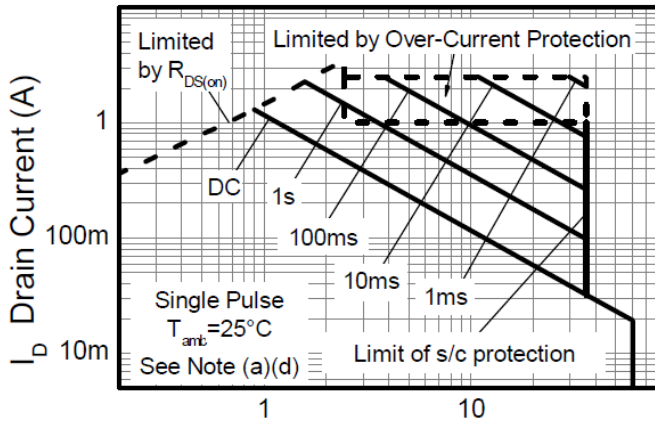

**Safe Operating Area**

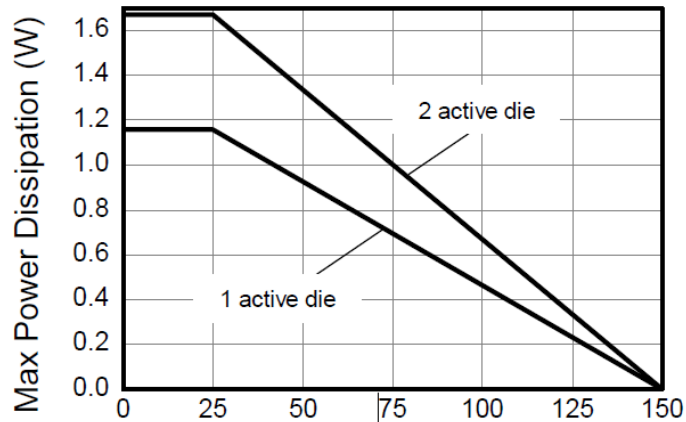

**Derating Curve**

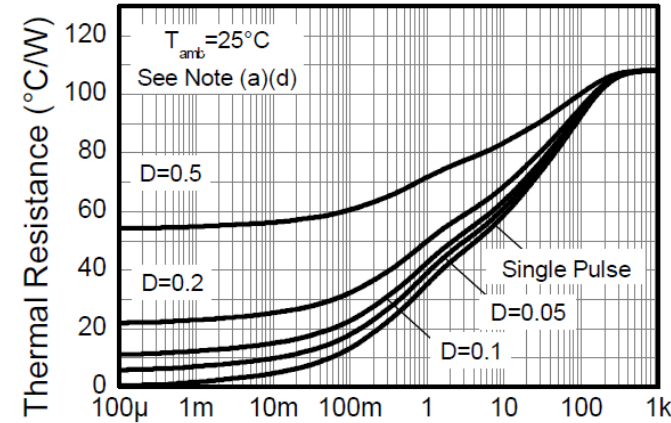

**Transient Thermal Impedance**

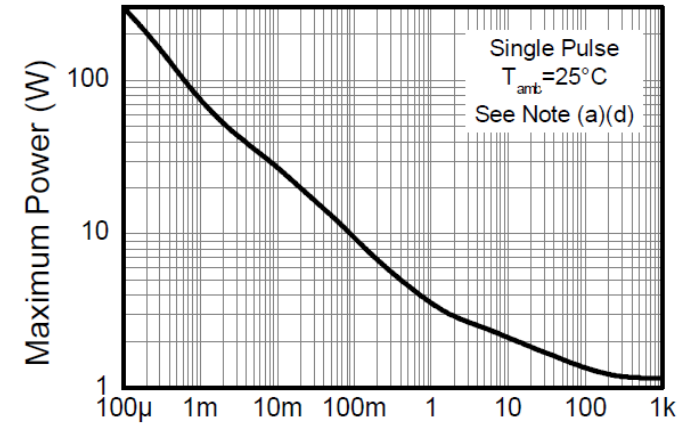

**Pulse Power Dissipation**

**Electrical Characteristics** (@ $T_{amb} = +25^{\circ}\text{C}$ , unless otherwise stated.)

Characteristic	Symbol	Min	Typ	Max	Unit	Test Condition
<b>Static Characteristics</b>						
Drain-Source Clamp Voltage	$V_{DS(AZ)}$	60	65	70	V	$I_D = 10\text{mA}$
Off State Drain Current	$I_{DSS}$	—	—	0.5	$\mu\text{A}$	$V_{DS} = 12\text{V}, V_{IN} = 0\text{V}$
		—	—	1		$V_{DS} = 36\text{V}, V_{IN} = 0\text{V}$
Input Threshold Voltage	$V_{IN(th)}$	0.7	1	1.5	V	$V_{DS} = V_{GS}, I_D = 1\text{mA}$
Input Current	$I_{IN}$	—	60	100	$\mu\text{A}$	$V_{IN} = +3\text{V}$
		—	120	200		$V_{IN} = +5\text{V}$
Input Current while Over Temperature Active	—	—	—	220	$\mu\text{A}$	$V_{IN} = +5\text{V}$
Static Drain-Source On-State Resistance	$R_{DS(on)}$	—	400	600	$\text{m}\Omega$	$V_{IN} = +3\text{V}, I_D = 1\text{A}$
		—	350	500		$V_{IN} = +5\text{V}, I_D = 1\text{A}$
Continuous Drain Current (Notes 6 & 10)	$I_D$	0.9	—	—	A	$V_{IN} = 3\text{V}; T_A = +25^{\circ}\text{C}$
		1	—	—		$V_{IN} = 5\text{V}; T_A = +25^{\circ}\text{C}$
Continuous Drain Current (Notes 6 & 9)	$I_D$	1.1	—	—	A	$V_{IN} = 3\text{V}; T_A = +25^{\circ}\text{C}$
		1.2	—	—		$V_{IN} = 5\text{V}; T_A = +25^{\circ}\text{C}$
Current Limit (Note 12)	$I_{D(LIM)}$	0.7	1.7	—	A	$V_{IN} = +3\text{V}$
		1	2.2	—		$V_{IN} = +5\text{V}$
<b>Dynamic Characteristics</b>						
Turn On Delay Time	$t_{d(on)}$	—	5	—	$\mu\text{s}$	$V_{DD} = 12\text{V}, I_D = 0.5\text{A},$ $V_{GS} = 5\text{V}$
Rise Time	$t_r$	—	10	—	$\mu\text{s}$	
Turn Off Delay Time	$t_{d(off)}$	—	45	—	$\mu\text{s}$	
Fall Time	$t_f$	—	15	—	$\mu\text{s}$	
<b>Over-Temperature Protection</b>						
Thermal Overload Trip Temperature (Note 13)	$T_{JT}$	150	175	—	$^{\circ}\text{C}$	—
Thermal Hysteresis (Note 13)	—	—	10	—	$^{\circ}\text{C}$	—

Notes: 12. The drain current is restricted only when the device is in saturation (see graph "Typical Output Characteristic"). This allows the device to be used in the fully on state without interference from the current limit. The device is fully protected at all drain currents, as the low power dissipation generated outside saturation makes current limit unnecessary.

13. Over-temperature protection is designed to prevent device destruction under fault conditions. Fault conditions are considered as "outside" normal operating range, so this part is not designed to withstand over-temperature for extended periods.

**Typical Characteristics**

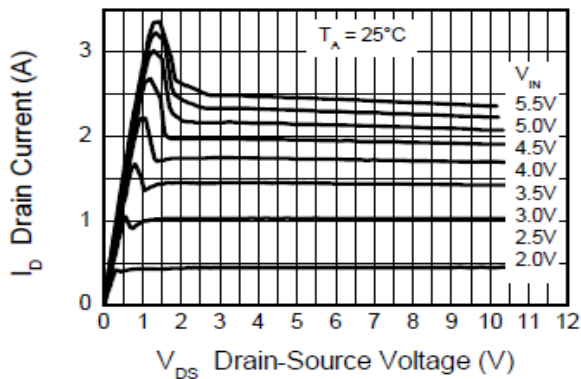

**Typical Output Characteristic**

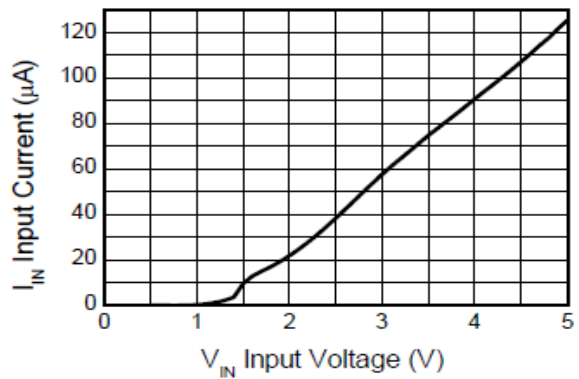

**Input Current vs Input Voltage**

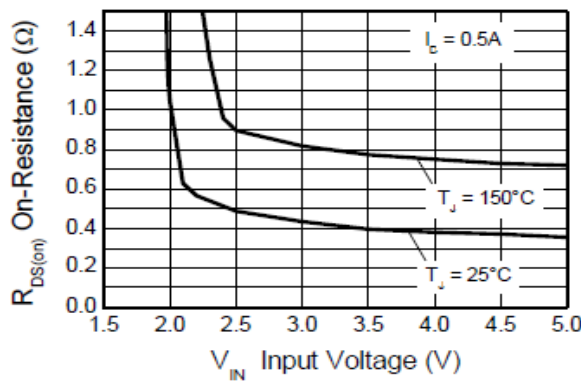

**On-Resistance vs Input Voltage**

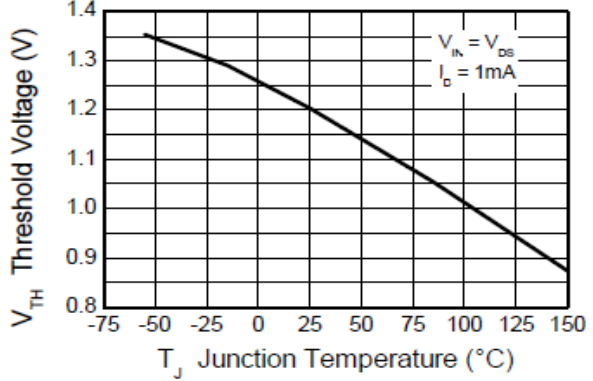

**Threshold Voltage vs Temperature**

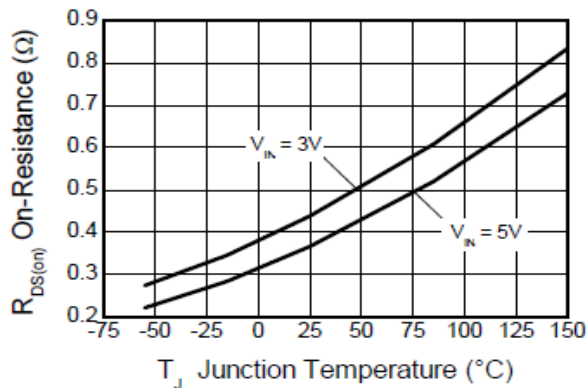

**On-Resistance vs Temperature**

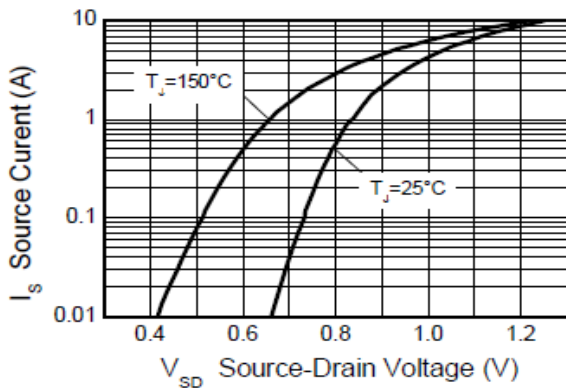

**Reverse Diode Characteristic**

**Typical Characteristics – (cont.)**

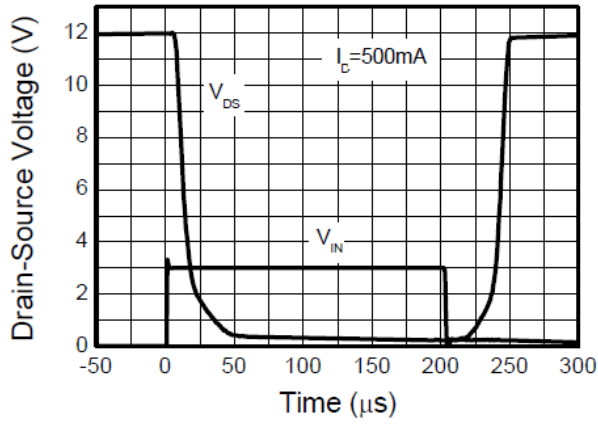

**Switching Speed**

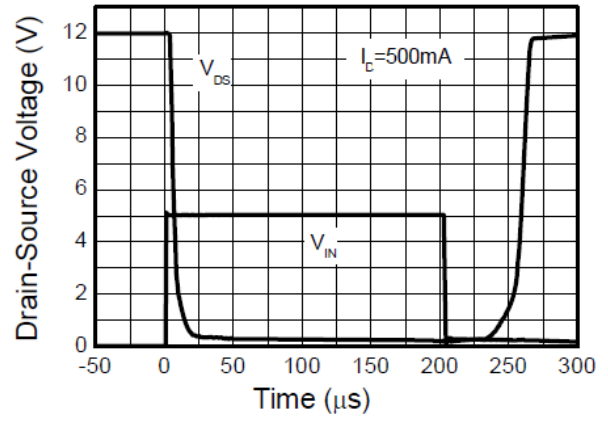

**Switching Speed**

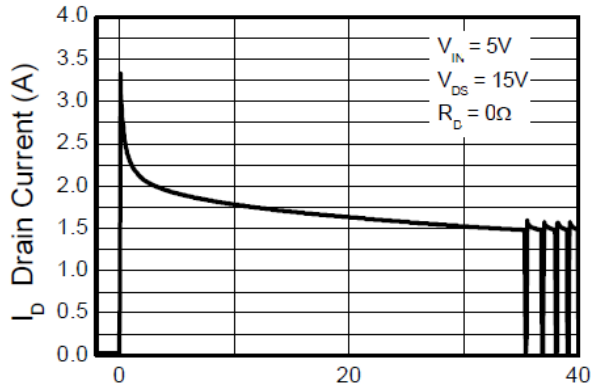

**Package Outline Dimensions**

Please see AP02002 at <http://www.diodes.com/datasheets/ap02002.pdf> for latest version.

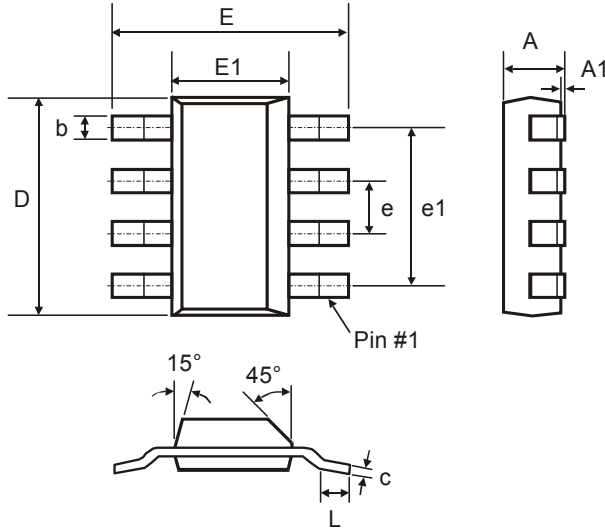

SM-8			
Dim	Min	Max	Typ
A	-	1.7	-
A1	0.02	0.1	-
b	-	0.7	-
c	0.24	0.32	-
D	6.3	6.7	-
e	-	-	1.53
e1	-	-	4.59
E	6.7	7.3	-
E1	3.3	3.7	-
L	0.9	-	-
All Dimensions in mm			

**Suggested Pad Layout**

Please see AP02001 at <http://www.diodes.com/datasheets/ap02001.pdf> for the latest version.

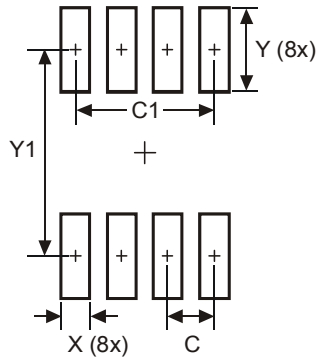

Dimensions	Value (in mm)
C	1.52
C1	4.6
X	0.95
Y	2.80
Y1	6.80



**IMPORTANT NOTICE**

DIODES INCORPORATED MAKES NO WARRANTY OF ANY KIND, EXPRESS OR IMPLIED, WITH REGARDS TO THIS DOCUMENT, INCLUDING, BUT NOT LIMITED TO, THE IMPLIED WARRANTIES OF MERCHANTABILITY AND FITNESS FOR A PARTICULAR PURPOSE (AND THEIR EQUIVALENTS UNDER THE LAWS OF ANY JURISDICTION).

Diodes Incorporated and its subsidiaries reserve the right to make modifications, enhancements, improvements, corrections or other changes without further notice to this document and any product described herein. Diodes Incorporated does not assume any liability arising out of the application or use of this document or any product described herein; neither does Diodes Incorporated convey any license under its patent or trademark rights, nor the rights of others. Any Customer or user of this document or products described herein in such applications shall assume all risks of such use and will agree to hold Diodes Incorporated and all the companies whose products are represented on Diodes Incorporated website, harmless against all damages.

Diodes Incorporated does not warrant or accept any liability whatsoever in respect of any products purchased through unauthorized sales channel. Should Customers purchase or use Diodes Incorporated products for any unintended or unauthorized application, Customers shall indemnify and hold Diodes Incorporated and its representatives harmless against all claims, damages, expenses, and attorney fees arising out of, directly or indirectly, any claim of personal injury or death associated with such unintended or unauthorized application.

Products described herein may be covered by one or more United States, international or foreign patents pending. Product names and markings noted herein may also be covered by one or more United States, international or foreign trademarks.

This document is written in English but may be translated into multiple languages for reference. Only the English version of this document is the final and determinative format released by Diodes Incorporated.

**LIFE SUPPORT**

Diodes Incorporated products are specifically not authorized for use as critical components in life support devices or systems without the express written approval of the Chief Executive Officer of Diodes Incorporated. As used herein:

A. Life support devices or systems are devices or systems which:

1. are intended to implant into the body, or
2. support or sustain life and whose failure to perform when properly used in accordance with instructions for use provided in the labeling can be reasonably expected to result in significant injury to the user.

B. A critical component is any component in a life support device or system whose failure to perform can be reasonably expected to cause the failure of the life support device or to affect its safety or effectiveness.

Customers represent that they have all necessary expertise in the safety and regulatory ramifications of their life support devices or systems, and acknowledge and agree that they are solely responsible for all legal, regulatory and safety-related requirements concerning their products and any use of Diodes Incorporated products in such safety-critical, life support devices or systems, notwithstanding any devices- or systems-related information or support that may be provided by Diodes Incorporated. Further, Customers must fully indemnify Diodes Incorporated and its representatives against any damages arising out of the use of Diodes Incorporated products in such safety-critical, life support devices or systems.

Copyright © 2013, Diodes Incorporated

[www.diodes.com](http://www.diodes.com)

单击下面可查看定价，库存，交付和生命周期等信息

[>>Diodes Incorporated\(达达科技\(美台\)\)](#)