

General Description

The AP2128 series are positive voltage regulator ICs fabricated by CMOS process. The AP2128 provides two kinds of output voltage operation modes for setting the output voltage. Fixed output voltage mode senses the output voltage on V_{OUT} , adjustable output voltage mode needs two resistors as a voltage divider.

The AP2128 series have features of low dropout voltage, low noise, high output voltage accuracy, and low current consumption which make them ideal for use in various battery-powered devices.

AP2128 have 1.0V, 1.2V, 1.5V, 1.8V, 2.5V, 2.8V, 3.0V, 3.3V, 3.9V, 4.2V, 4.75V, 5.2V fixed voltage versions and 0.8V to 5.5V adjustable voltage version.

AP2128 series are available in SOT-23-5 package.

Features

- Wide Operating Voltage: 2.5V to 6V
- Low Dropout Voltage: 170mV@300mA for $V_{OUT}=3.3V$, 140mV@300mA for $V_{OUT}=5.2V$
- High Output Voltage Accuracy: $\pm 2\%$
- High Ripple Rejection: 68dB@ $f=1kHz$, 54dB@ $f=10kHz$
- Low Standby Current: 0.1 μA
- Low Quiescent Current: 60 μA Typical
- Low Output Noise: 60 μV_{rms} @ $V_{OUT}=0.8V$
- Short Current Limit: 50mA
- Over Temperature Protection
- Compatible with Low ESR Ceramic Capacitor: 1 μF for C_{IN} and C_{OUT}
- Excellent Line/Load Regulation
- Soft Start Time: 50 μs
- Auto Discharge Resistance: $R_{DS(ON)}=60\Omega$

Applications

- Datacom
- Notebook Computers
- Mother Board

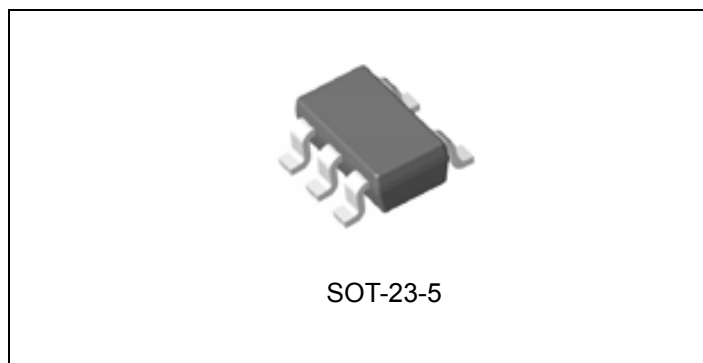

Figure 1. Package Type of AP2128

Pin Configuration

K Package
(SOT-23-5)

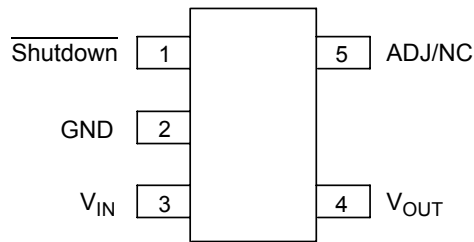
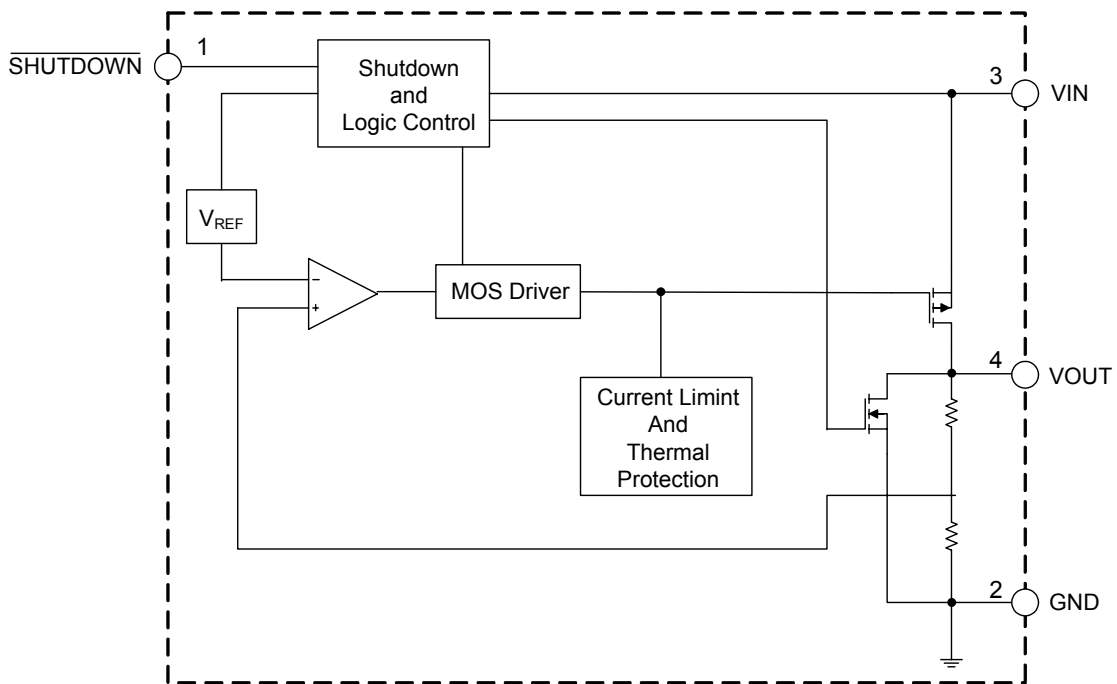

Figure 2. Pin Configuration of AP2128 (Top View)

Functional Block Diagram



Fixed Version

Functional Block Diagram (Continued)

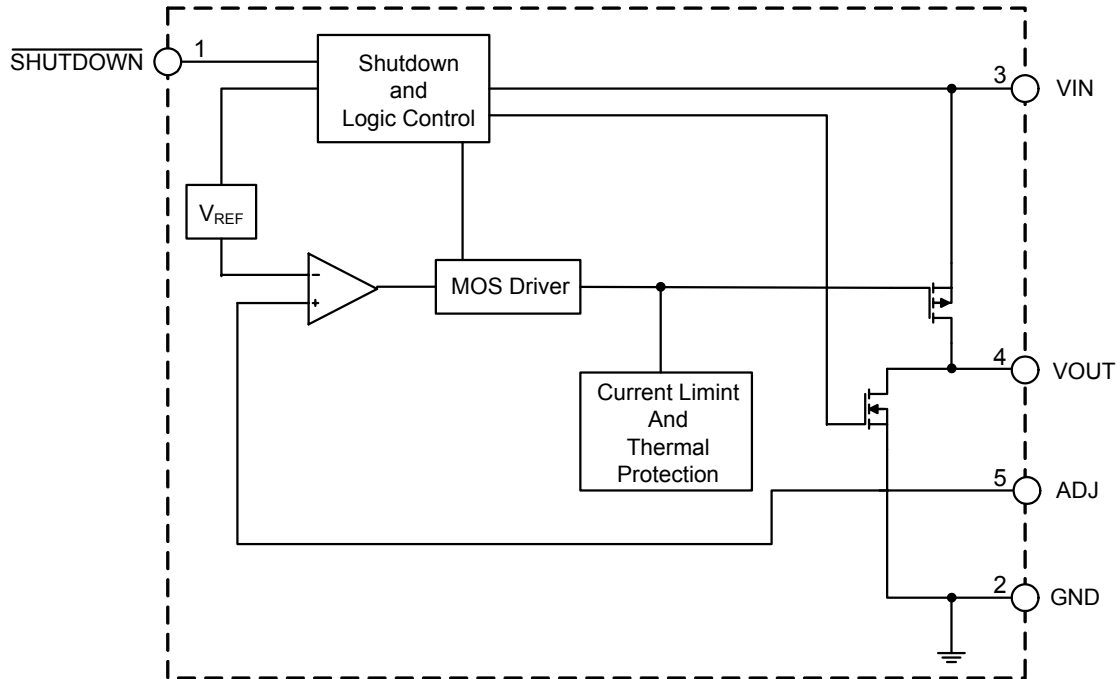

Adjustable Version

Figure 3. Functional Block Diagram of AP2128



300mA HIGH SPEED, EXTREMELY LOW NOISE CMOS LDO REGULATOR AP2128

Ordering Information

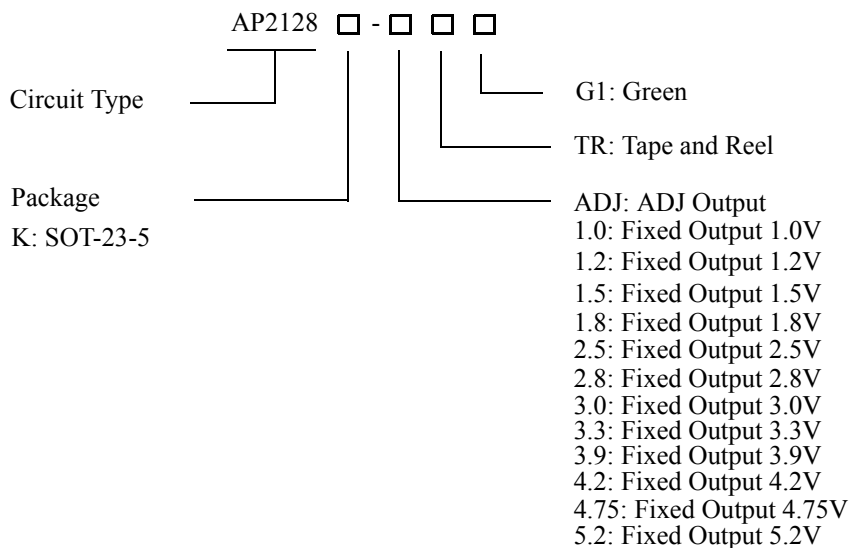

Product	Package	Temperature Range	Part Number	Marking ID	Packing Type
AP2128	SOT-23-5	-40 to 85°C	AP2128K- ADJTRG1	FAD	Tape & Reel
			AP2128K-1.0TRG1	FAJ	Tape & Reel
			AP2128K-1.2TRG1	FAK	Tape & Reel
			AP2128K-1.5TRG1	GAN	Tape & Reel
			AP2128K-1.8TRG1	GAP	Tape & Reel
			AP2128K-2.5TRG1	GAQ	Tape & Reel
			AP2128K-2.8TRG1	GAR	Tape & Reel
			AP2128K-3.0TRG1	GAW	Tape & Reel
			AP2128K-3.3TRG1	FAL	Tape & Reel
			AP2128K-3.9TRG1	GBU	Tape & Reel
			AP2128K-4.2TRG1	GAZ	Tape & Reel
			AP2128K-4.75TRG1	GFZ	Tape & Reel
			AP2128K-5.2TRG1	GAV	Tape & Reel

BCD Semiconductor's products, as designated with "G1" suffix in the part number, are RoHS compliant and Green.

**300mA HIGH SPEED, EXTREMELY LOW NOISE CMOS LDO REGULATOR****AP2128****Absolute Maximum Ratings (Note 1)**

Parameter	Symbol	Value	Unit
Input Voltage	V_{IN}	6.5	V
Shutdown Input Voltage	V_{CE}	-0.3 to $V_{IN}+0.3$	V
Output Current	I_{OUT}	450	mA
Junction Temperature	T_J	150	°C
Storage Temperature Range	T_{STG}	-65 to 150	°C
Lead Temperature (Soldering, 10sec)	T_{LEAD}	260	°C
Thermal Resistance	θ_{JA}	250	°C/W
ESD (Human Body Model)	ESD	6000	V
ESD (Machine Model)	ESD	200	V

Note 1: Stresses greater than those listed under "Absolute Maximum Ratings" may cause permanent damage to the device. These are stress ratings only, and functional operation of the device at these or any other conditions beyond those indicated under "Recommended Operating Conditions" is not implied. Exposure to "Absolute Maximum Ratings" for extended periods may affect device reliability.

Recommended Operating Conditions

Parameter	Symbol	Min	Max	Unit
Input Voltage	V_{IN}	2.5	6	V
Operating Ambient Temperature Range	T_A	-40	85	°C



300mA HIGH SPEED, EXTREMELY LOW NOISE CMOS LDO REGULATOR AP2128

Electrical Characteristics

(AP2128-ADJ, $V_{IN\ min}=2.5V$, $C_{IN}=1\mu F$, $C_{OUT}=1\mu F$, Bold typeface applies over $-40^{\circ}C \leq T_A \leq 85^{\circ}C$, unless otherwise specified.)

Parameter	Symbol	Conditions	Min	Typ	Max	Unit
Reference Voltage	V_{REF}	$V_{IN}=2.5V$ $1mA \leq I_{OUT} \leq 300mA$	0.784	0.8	0.816	V
Input Voltage	V_{IN}		2.5		6	V
Maximum Output Current	$I_{OUT(MAX)}$	$V_{IN}=2.5V$, $V_{OUT}=98\% \times V_{OUT}$	300	400		mA
Current Limit	I_{LIMIT}	$V_{IN}=2.5V$		450		mA
Load Regulation	$\frac{\Delta V_{OUT}}{(\Delta I_{OUT} \times V_{OUT})}$	$V_{IN}=2.5V$, $1mA \leq I_{OUT} \leq 300mA$			0.6	%/A
Line Regulation	$\frac{\Delta V_{OUT}}{(\Delta V_{IN} \times V_{OUT})}$	$V_{IN}=2.5V$ to 6V $I_{OUT}=30mA$			0.06	%/V
Quiescent Current	I_Q	$V_{IN}=2.5V$, $I_{OUT}=0mA$		60	90	μA
Standby Current	I_{STD}	$V_{IN}=2.5V$, $V_{SHUTDOWN}$ in off mode		0.1	1.0	μA
Power Supply Rejection Ratio	PSRR	Ripple 1Vp-p $V_{IN}=3V$	$f=100Hz$		68	dB
			$f=1KHz$		68	dB
			$f=10KHz$		54	dB
Output Voltage Temperature Coefficient	$\frac{(\Delta V_{OUT}/V_{OUT})}{\Delta T}$	$I_{OUT}=30mA$, $-40^{\circ}C \leq T_A \leq 85^{\circ}C$		± 100		ppm/ $^{\circ}C$
Short Current Limit	I_{SHORT}	$V_{OUT}=0V$		50		mA
Soft Start Time	t_{UP}			50		μs
RMS Output Noise	V_{NOISE}	$T_A=25^{\circ}C$, $10Hz \leq f \leq 100kHz$, $V_{OUT}=0.8V$		60		μV_{rms}
Shutdown "High" Voltage		Shutdown input voltage "High"	1.5		6	V
Shutdown "Low" Voltage		Shutdown input voltage "Low"	0		0.4	V
V_{OUT} Discharge MOSFET $R_{DS(ON)}$		Shutdown input voltage "Low"		60		Ω
Shutdown Pull Down Resistance				3		$M\Omega$
Thermal Shutdown				165		$^{\circ}C$
Thermal Shutdown Hysteresis				30		$^{\circ}C$
Thermal Resistance	θ_{JC}	SOT-23-5		150		$^{\circ}C/W$



300mA HIGH SPEED, EXTREMELY LOW NOISE CMOS LDO REGULATOR AP2128

Electrical Characteristics (Continued)

(AP2128-1.0V/1.2V/1.5V/1.8V, $V_{INmin.}=2.5V$, $C_{IN}=1\mu F$, $C_{OUT}=1\mu F$, Bold typeface applies over $-40^{\circ}C \leq T_A \leq 85^{\circ}C$, unless otherwise specified.)

Parameter	Symbol	Conditions	Min	Typ	Max	Unit
Output Voltage	V_{OUT}	$V_{IN}=2.5V$ $1mA \leq I_{OUT} \leq 300mA$	$98\% \times V_{OUT}$		$102\% \times V_{OUT}$	V
Input Voltage	V_{IN}		2.5		6	V
Maximum Output Current	$I_{OUT(MAX)}$	$V_{IN}=2.5V$, $V_{OUT}=98\% \times V_{OUT}$	300	400		mA
Current Limit	I_{LIMIT}	$V_{IN}=2.5V$		450		mA
Load Regulation	$\frac{\Delta V_{OUT}}{(\Delta I_{OUT} \times V_{OUT})}$	$V_{IN}=2.5V$, $1mA \leq I_{OUT} \leq 300mA$			0.6	%/A
Line Regulation	$\frac{\Delta V_{OUT}}{(\Delta V_{IN} \times V_{OUT})}$	$V_{IN}=2.5V$ to 6V $I_{OUT}=30mA$			0.06	%/V
Dropout Voltage	V_{DROP}	$V_{OUT}=1.0V, I_{OUT}=300mA$		1400	1500	mV
		$V_{OUT}=1.2V, I_{OUT}=300mA$		1200	1300	
		$V_{OUT}=1.5V, I_{OUT}=300mA$		900	1000	
		$V_{OUT}=1.8V, I_{OUT}=300mA$		600	700	
Quiescent Current	I_Q	$V_{IN}=2.5V, I_{OUT}=0mA$		60	90	μA
Standby Current	I_{STD}	$V_{IN}=2.5V$, $\overline{V_{SHUTDOWN}}$ in off mode		0.1	1.0	μA
Power Supply Rejection Ratio	PSRR	Ripple 1Vp-p $V_{IN}=3V$	$f=100Hz$		68	dB
			$f=1KHz$		68	dB
			$f=10KHz$		54	dB
Output Voltage Temperature Coefficient	$\frac{(\Delta V_{OUT}/V_{OUT})}{\Delta T}$	$I_{OUT}=30mA, -40^{\circ}C \leq T_A \leq 85^{\circ}C$		± 100		ppm/ $^{\circ}C$
Short Current Limit	I_{SHORT}	$V_{OUT}=0V$		50		mA
Soft Start Time	t_{UP}			50		μs
Shutdown "High" Voltage		Shutdown input voltage "High"	1.5		6	V
Shutdown "Low" Voltage		Shutdown input voltage "Low"	0		0.4	V
V_{OUT} Discharge MOSFET $R_{DS(ON)}$		Shutdown input voltage "Low"		60		Ω
Shutdown Pull Down Resistance				3		M Ω
Thermal Shutdown				165		$^{\circ}C$
Thermal Shutdown Hysteresis				30		$^{\circ}C$
Thermal Resistance	θ_{JC}	SOT-23-5		150		$^{\circ}C/W$



300mA HIGH SPEED, EXTREMELY LOW NOISE CMOS LDO REGULATOR AP2128

Electrical Characteristics (Continued)

(AP2128-2.5V/2.8V/3.0V/3.3V/3.9V/4.2V/4.75V, $V_{IN}=V_{OUT}+1V$; AP2128-5.2V, $V_{IN}=6V$, $C_{IN}=1\mu F$, $C_{OUT}=1\mu F$, Bold type-face applies over $-40^{\circ}C \leq T_A \leq 85^{\circ}C$, unless otherwise specified.)

Parameter	Symbol	Conditions	Min	Typ	Max	Unit
Output Voltage	V_{OUT}	$V_{IN}=V_{OUT}+1V$ $1mA \leq I_{OUT} \leq 300mA$	$98\% \times V_{OUT}$		$102\% \times V_{OUT}$	V
Input Voltage	V_{IN}		2.5		6	V
Maximum Output Current	$I_{OUT(MAX)}$	$V_{IN}-V_{OUT}=1V$, $V_{OUT}=98\% \times V_{OUT}$	300	400		mA
Current Limit	I_{LIMIT}	$V_{IN}-V_{OUT}=1V$		450		mA
Load Regulation	$\frac{\Delta V_{OUT}}{(\Delta I_{OUT} \times V_{OUT})}$	$V_{IN}-V_{OUT}=1V$, $1mA \leq I_{OUT} \leq 300mA$			0.6	%/A
Line Regulation	$\frac{\Delta V_{OUT}}{(\Delta V_{IN} \times V_{OUT})}$	$V_{OUT}+0.5V \leq V_{IN} \leq 6V$, $I_{OUT}=30mA$			0.06	%/V
Dropout Voltage	V_{DROP}	$V_{OUT}=2.5V, 2.8V, 3.0V, 3.3V,$ $3.9V, 4.2V, I_{OUT}=300mA$		170	300	mV
		$V_{OUT}=4.75V$ and $5.2V$, $I_{OUT}=300mA$		140	300	
Quiescent Current	I_Q	$V_{IN}=V_{OUT}+1V, I_{OUT}=0mA$		60	90	μA
Standby Current	I_{STD}	$V_{IN}=V_{OUT}+1V$, $V_{SHUTDOWN}$ in off mode		0.1	1.0	μA
Power Supply Rejection Ratio	PSRR	AP2128-2.5V to 4.2V, Ripple 1Vp-p $V_{IN}=V_{OUT}+1V$	f=100Hz		68	dB
			f=1KHz		68	
			f=10KHz		54	
		AP2128-4.75V, Ripple 0.5Vp-p $V_{IN}=V_{OUT}+1V$	f=100Hz		63	
			f=1KHz		63	
			f=10KHz		45	
		AP2128-5.2V, Ripple 0.5Vp-p $V_{IN}=6V$	f=100Hz		63	
			f=1KHz		63	
			f=10KHz		45	
Output Voltage Temperature Coefficient	$\frac{(\Delta V_{OUT}/V_{OUT})}{\Delta T}$	$I_{OUT}=30mA, -40^{\circ}C \leq T_A \leq 85^{\circ}C$		± 100		ppm/ $^{\circ}C$
Short Current Limit	I_{SHORT}	$V_{OUT}=0V$		50		mA

**300mA HIGH SPEED, EXTREMELY LOW NOISE CMOS LDO REGULATOR****AP2128****Electrical Characteristics (Continued)**

(AP2128-2.5V/2.8V/3.0V/3.3V/3.9V/4.2V/4.75V, $V_{IN}=V_{OUT}+1V$; AP2128-5.2V, $V_{IN}=6V$, $C_{IN}=1\mu F$, $C_{OUT}=1\mu F$, Bold typeface applies over $-40^{\circ}C \leq T_A \leq 85^{\circ}C$, unless otherwise specified.)

Parameter	Symbol	Conditions	Min	Typ	Max	Unit
Soft Start Time	t_{UP}			50		μs
Shutdown "High" Voltage		Shutdown input voltage "High"	1.5		6	V
Shutdown "Low" Voltage		Shutdown input voltage "Low"	0		0.4	V
V_{OUT} Discharge MOSFET $R_{DS(ON)}$		Shutdown input voltage "Low"		60		Ω
Shutdown Pull Down Resistance				3		$M\Omega$
Thermal Shutdown				165		$^{\circ}C$
Thermal Shutdown Hysteresis				30		$^{\circ}C$
Thermal Resistance	θ_{JC}	SOT-23-5		150		$^{\circ}C/W$



300mA HIGH SPEED, EXTREMELY LOW NOISE CMOS LDO REGULATOR AP2128

Typical Performance Characteristics

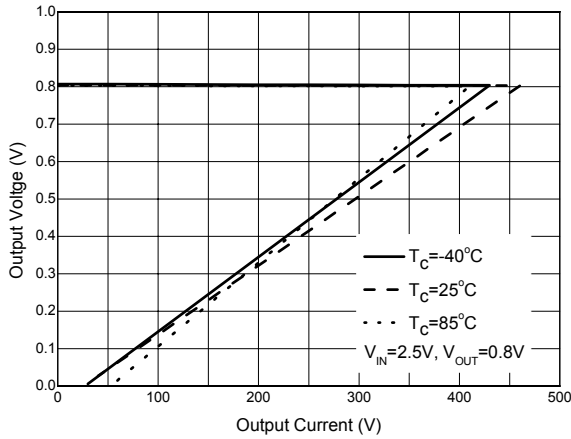

Figure 4. Output Voltage vs. Output Current

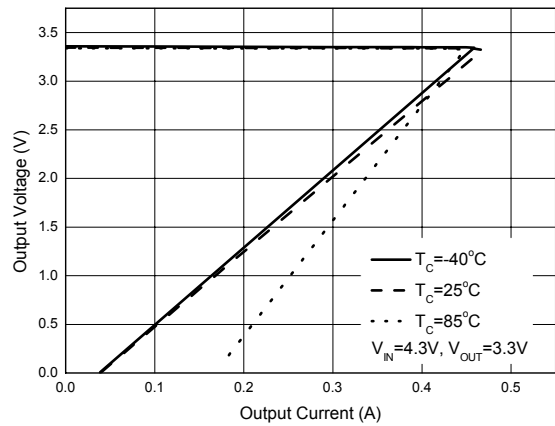

Figure 5. Output Voltage vs. Output Current

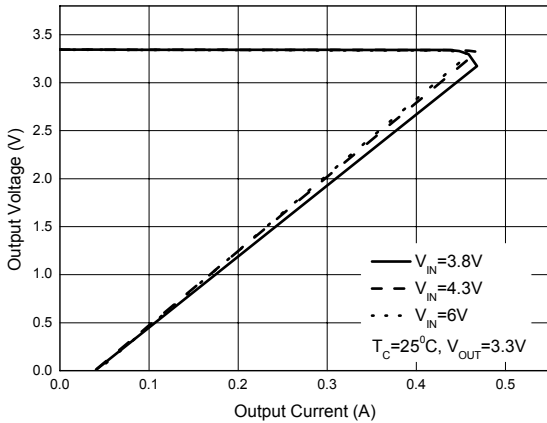

Figure 6. Output Voltage vs. Output Current

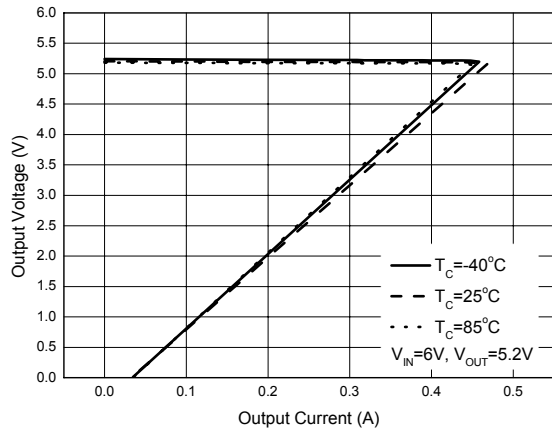

Figure 7. Output Voltage vs. Output Current



300mA HIGH SPEED, EXTREMELY LOW NOISE CMOS LDO REGULATOR AP2128

Typical Performance Characteristics (Continued)

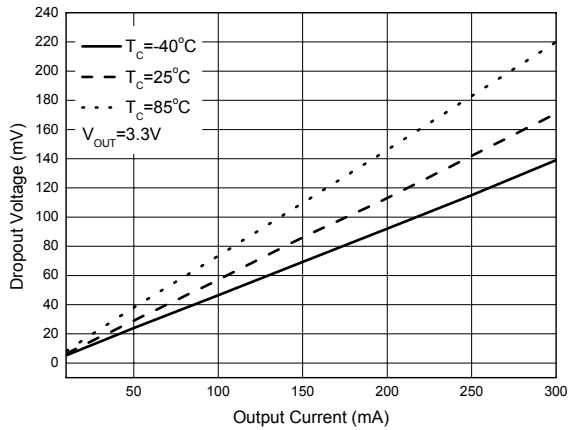

Figure 8. Dropout Voltage vs. Output Current

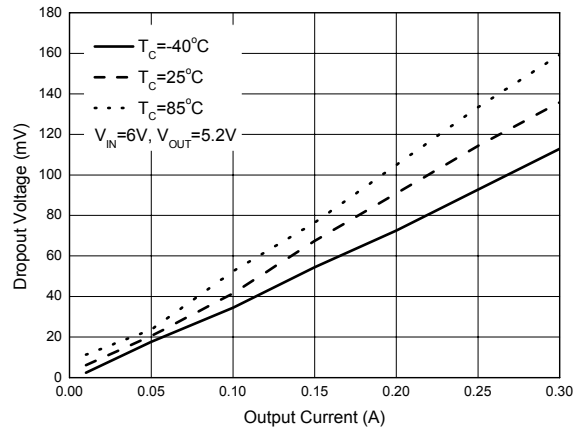

Figure 9. Dropout Voltage vs. Output Current

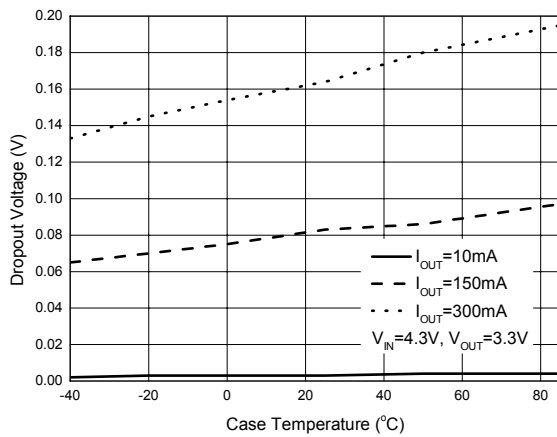

Figure 10. Dropout Voltage vs. Case Temperature

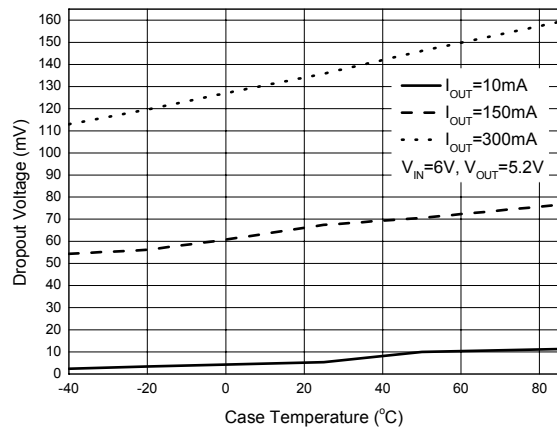

Figure 11. Dropout Voltage vs. Case Temperature



300mA HIGH SPEED, EXTREMELY LOW NOISE CMOS LDO REGULATOR AP2128

Typical Performance Characteristics (Continued)

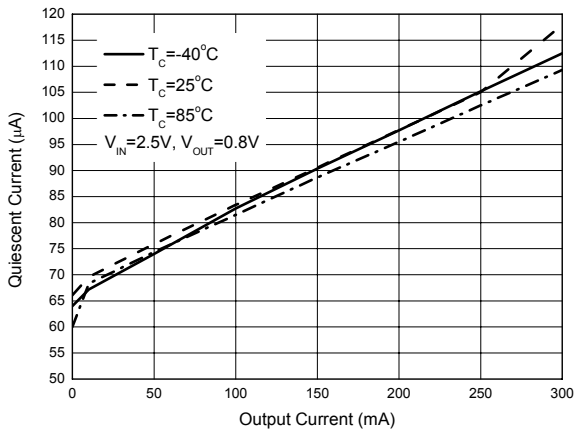

Figure 12. Quiescent Current vs. Output Current

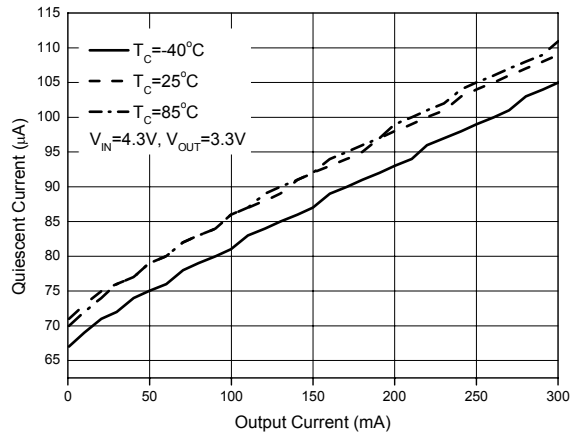

Figure 13. Quiescent Current vs. Output Current

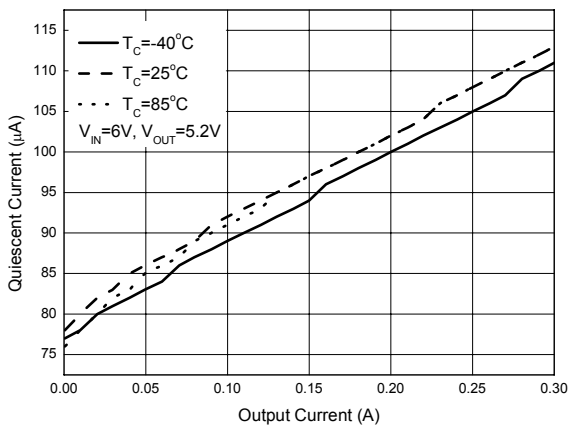

Figure 14. Quiescent Current vs. Output Current

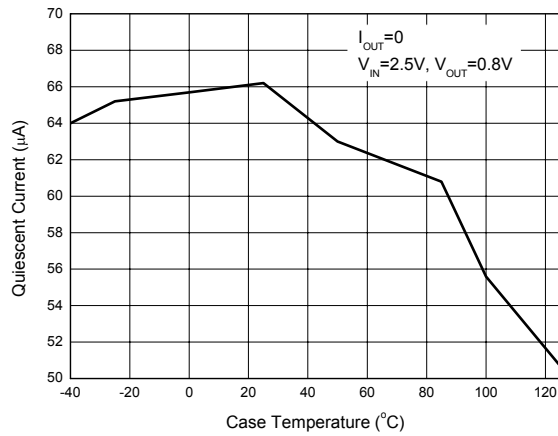

Figure 15. Quiescent Current vs. Case Temperature



300mA HIGH SPEED, EXTREMELY LOW NOISE CMOS LDO REGULATOR AP2128

Typical Performance Characteristics (Continued)

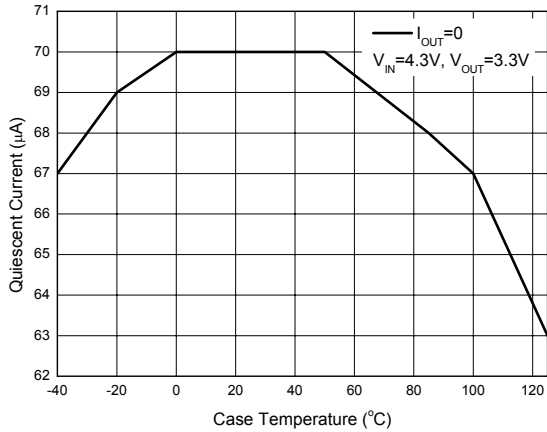

Figure 16. Quiescent Current vs. Case Temperature

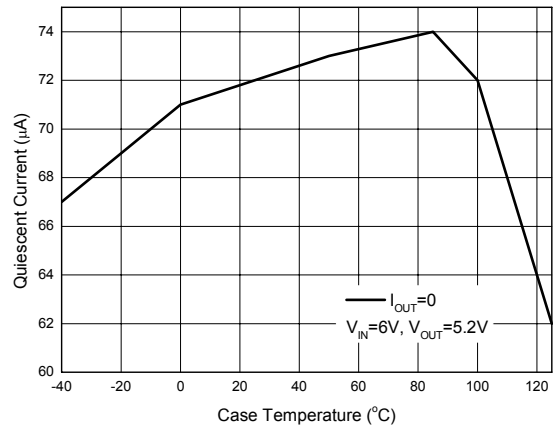

Figure 17. Quiescent Current vs. Case Temperature

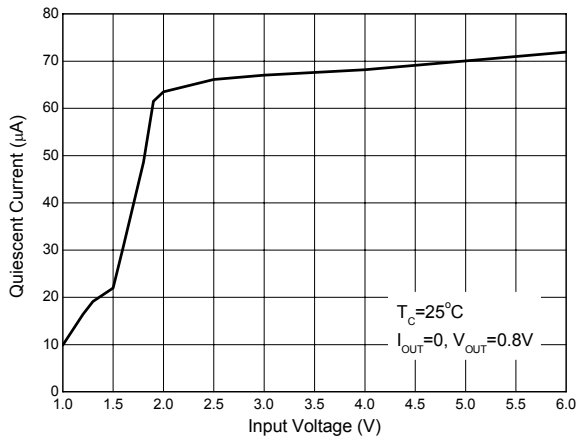

Figure 18. Quiescent Current vs. Input Voltage

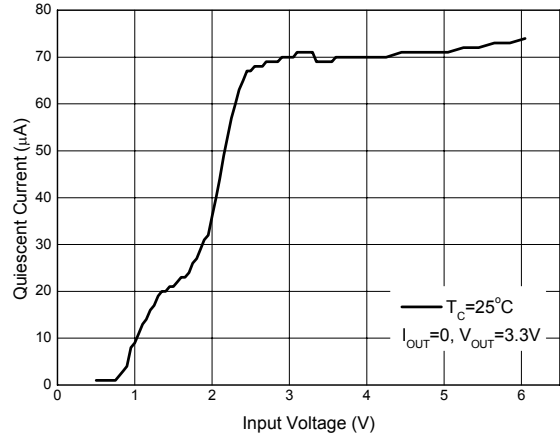

Figure 19. Quiescent Current vs. Input Voltage



300mA HIGH SPEED, EXTREMELY LOW NOISE CMOS LDO REGULATOR AP2128

Typical Performance Characteristics (Continued)

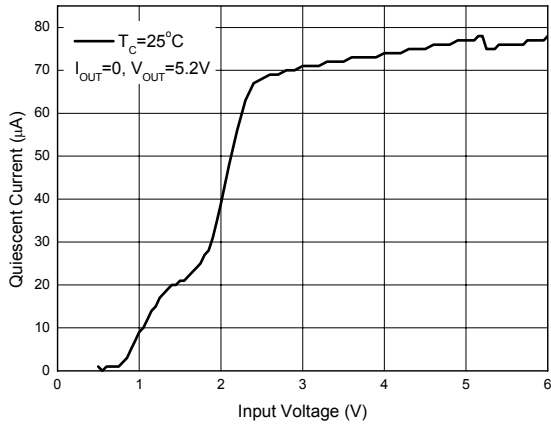

Figure 20. Quiescent Current vs. Input Voltage

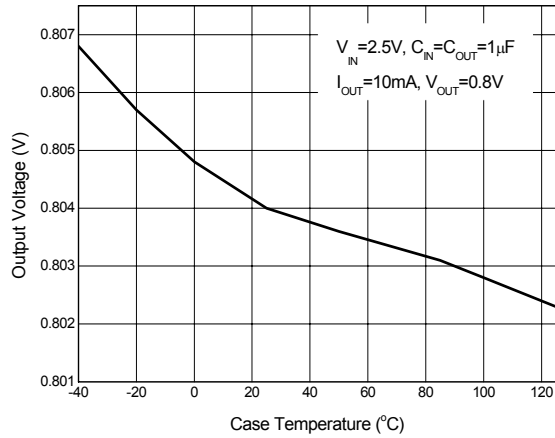

Figure 21. Output Voltage vs. Case Temperature

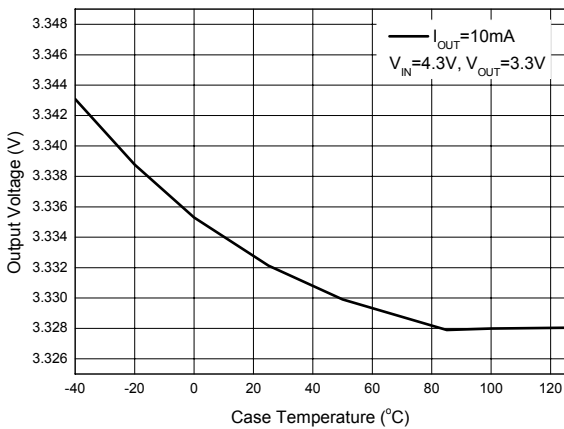

Figure 22. Output Voltage vs. Case Temperature

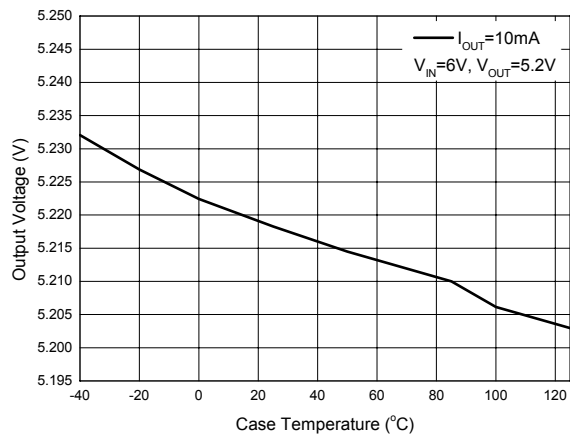

Figure 23. Output Voltage vs. Case Temperature



300mA HIGH SPEED, EXTREMELY LOW NOISE CMOS LDO REGULATOR AP2128

Typical Performance Characteristics (Continued)

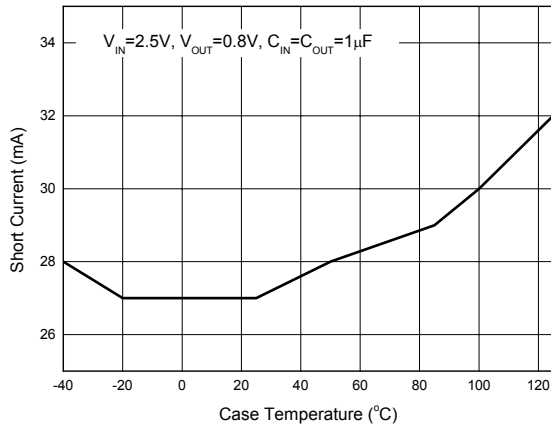

Figure 24. Short Current vs. Case Temperature

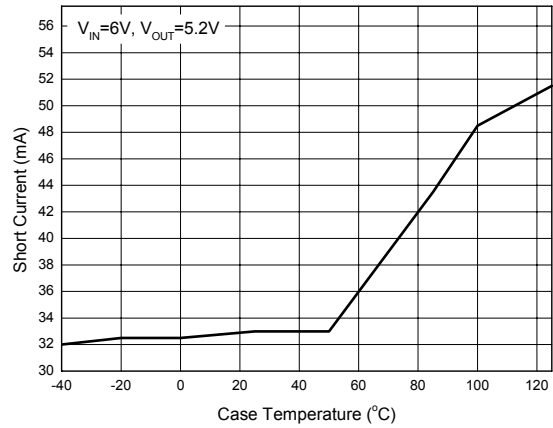

Figure 25. Short Current vs. Case Temperature

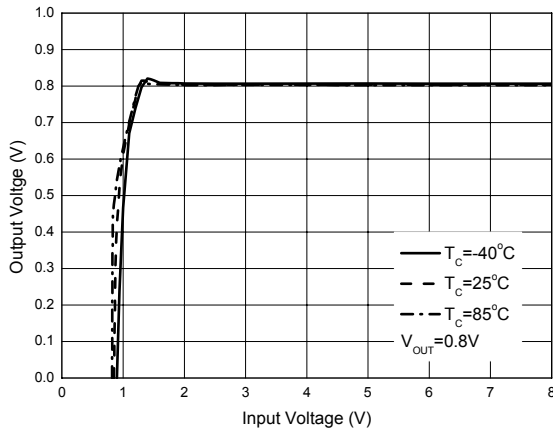

Figure 26. Output Voltage vs. Input Voltage ($I_{OUT}=0mA$)

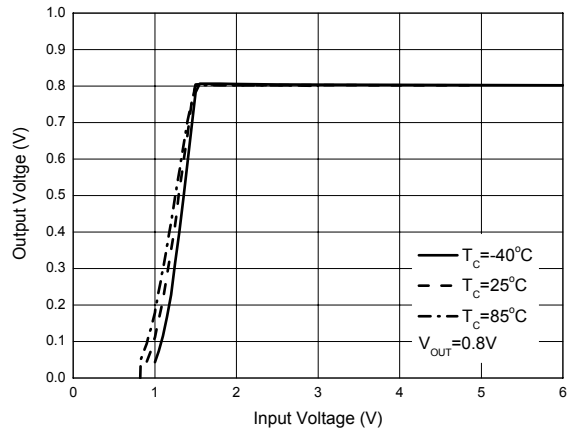

Figure 27. Output Voltage vs. Input Voltage ($I_{OUT}=300mA$)



300mA HIGH SPEED, EXTREMELY LOW NOISE CMOS LDO REGULATOR AP2128

Typical Performance Characteristics (Continued)

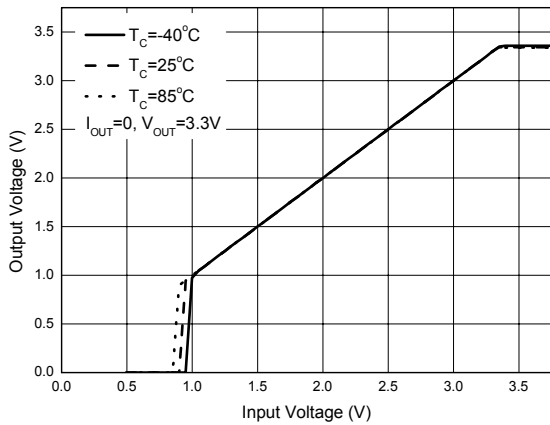

Figure 28. Output Voltage vs. Input Voltage

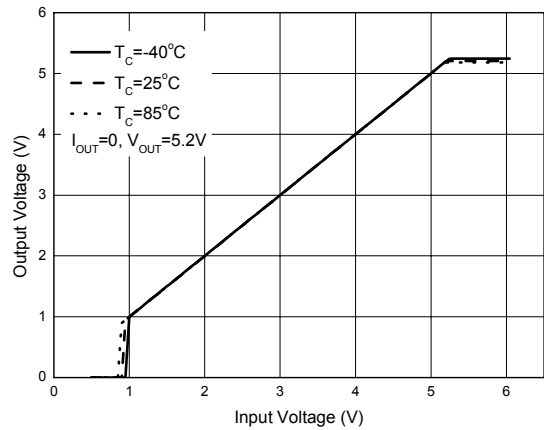

Figure 29. Output Voltage vs. Input Voltage

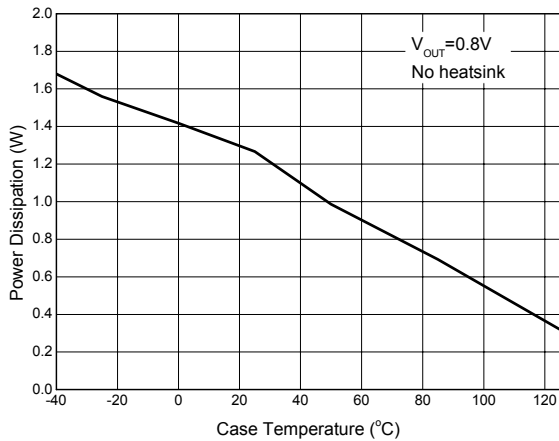

Figure 30. Power Dissipation vs. Case Temperature

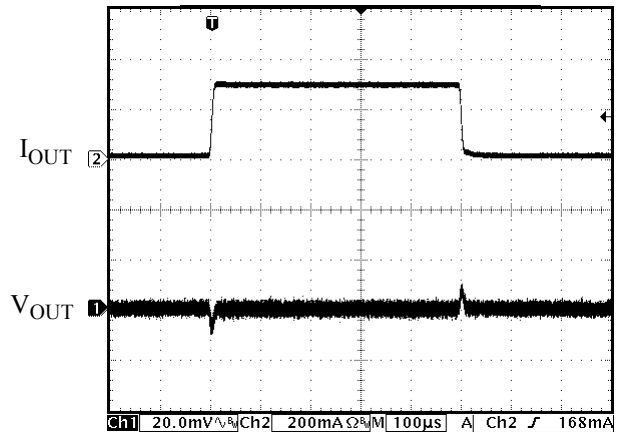

Figure 31. Load Transient
(Conditions: $C_{IN}=C_{OUT}=1\mu F$, $V_{IN}=2.5V$, $V_{OUT}=0.8V$, $I_{OUT}=10mA$ to $300mA$)

Typical Performance Characteristics (Continued)

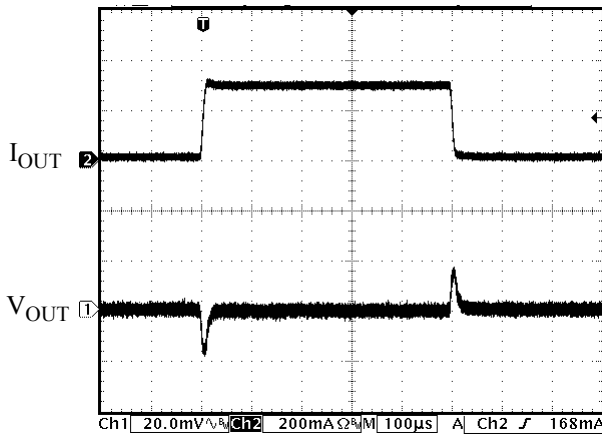

Figure 32. Load Transient

(Conditions: $C_{IN}=C_{OUT}=1\mu F$, $V_{IN}=4.4V$, $V_{OUT}=3.3V$, $I_{OUT}=10mA$ to $300mA$)

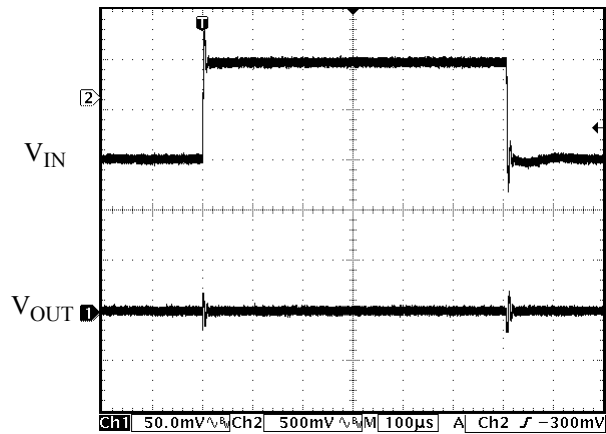

Figure 33. Line Transient

(Conditions: $I_{OUT}=30mA$, $C_{IN}=C_{OUT}=1\mu F$, $V_{IN}=2.5$ to $3.5V$, $V_{OUT}=0.8V$)

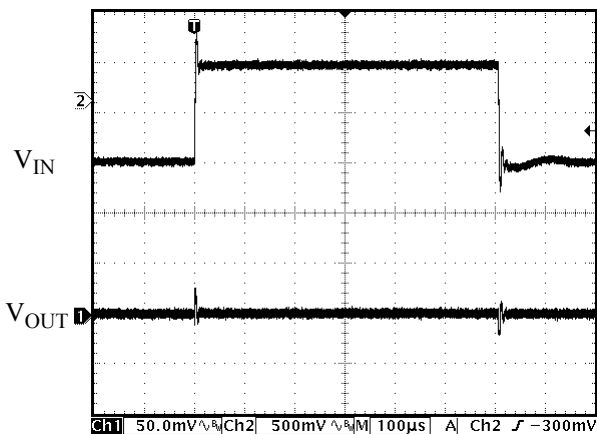

Figure 34. Line Transient

(Conditions: $I_{OUT}=30mA$, $C_{IN}=C_{OUT}=1\mu F$, $V_{IN}=4$ to $5V$, $V_{OUT}=3.3V$)

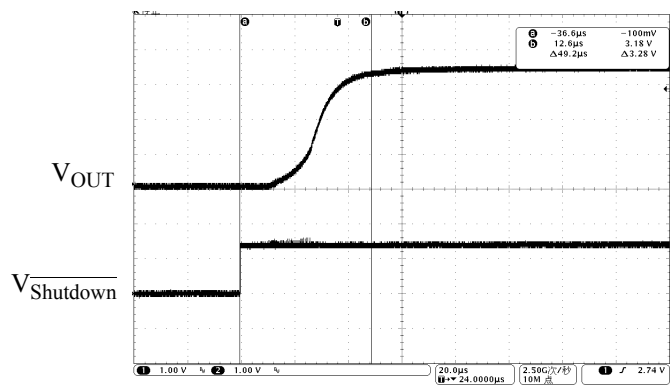

Figure 35. Soft Start Time

(Conditions: $I_{OUT}=0mA$, $C_{IN}=C_{OUT}=1\mu F$, $V_{Shutdown}=0$ to $2V$, $V_{OUT}=3.3V$)



300mA HIGH SPEED, EXTREMELY LOW NOISE CMOS LDO REGULATOR AP2128

Typical Performance Characteristics (Continued)

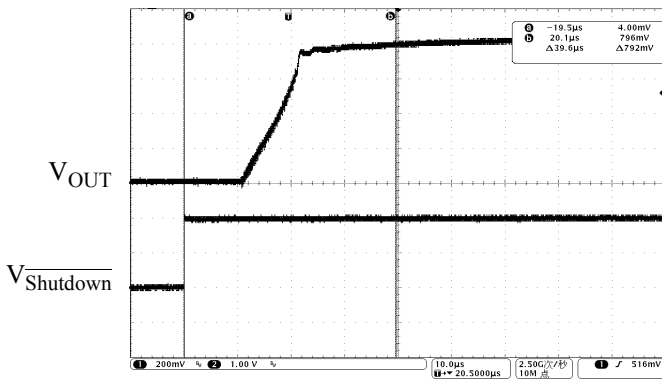

Figure 36. Soft Start Time
 (Conditions: $I_{OUT}=0mA$, $C_{IN}=C_{OUT}=1\mu F$,
 $V_{Shutdown}=0$ to $2V$, $V_{OUT}=0.8V$)

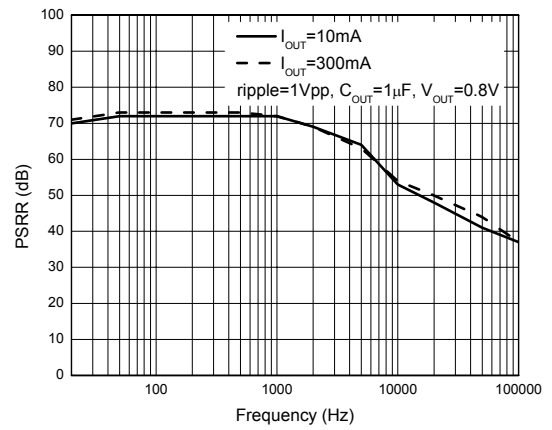

Figure 37. PSRR vs. Frequency

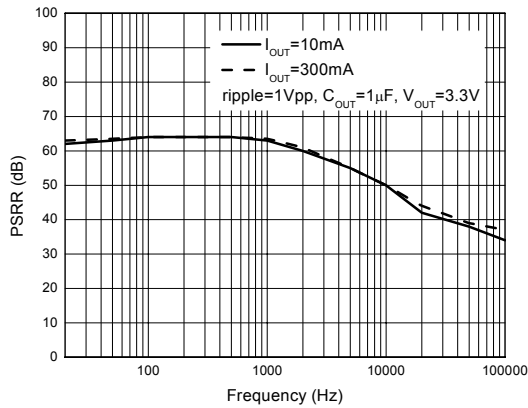

Figure 38. PSRR vs. Frequency

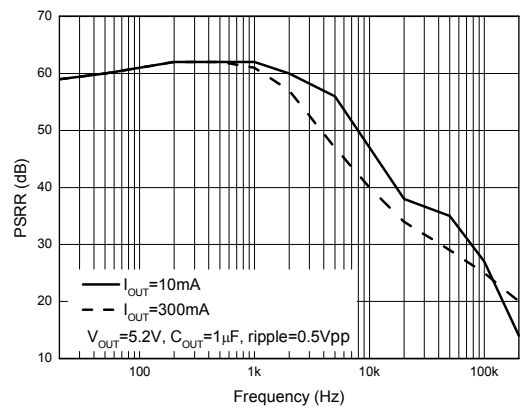
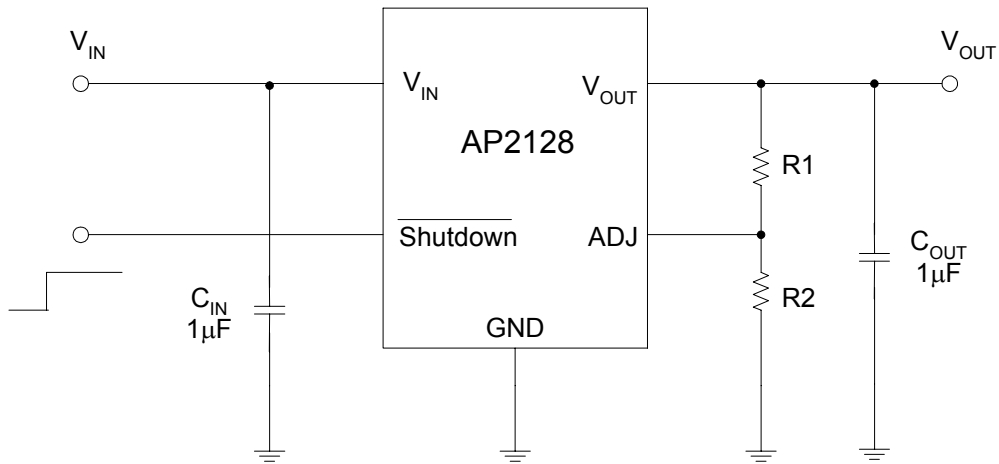
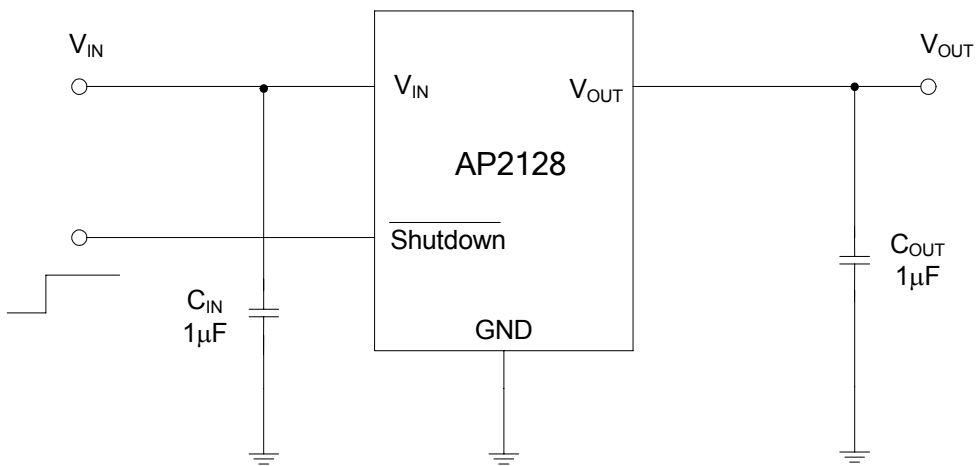

Figure 39. PSRR vs. Frequency

Typical Application



$$V_{OUT} = 0.8(1 + R1/R2) \text{ V}$$



$$V_{OUT} = 1.0\text{V to } 5.2\text{V}$$

Figure 40. Typical Application of AP2128



300mA HIGH SPEED, EXTREMELY LOW NOISE CMOS LDO REGULATOR AP2128

Mechanical Dimensions

SOT-23-5

Unit: mm(inch)

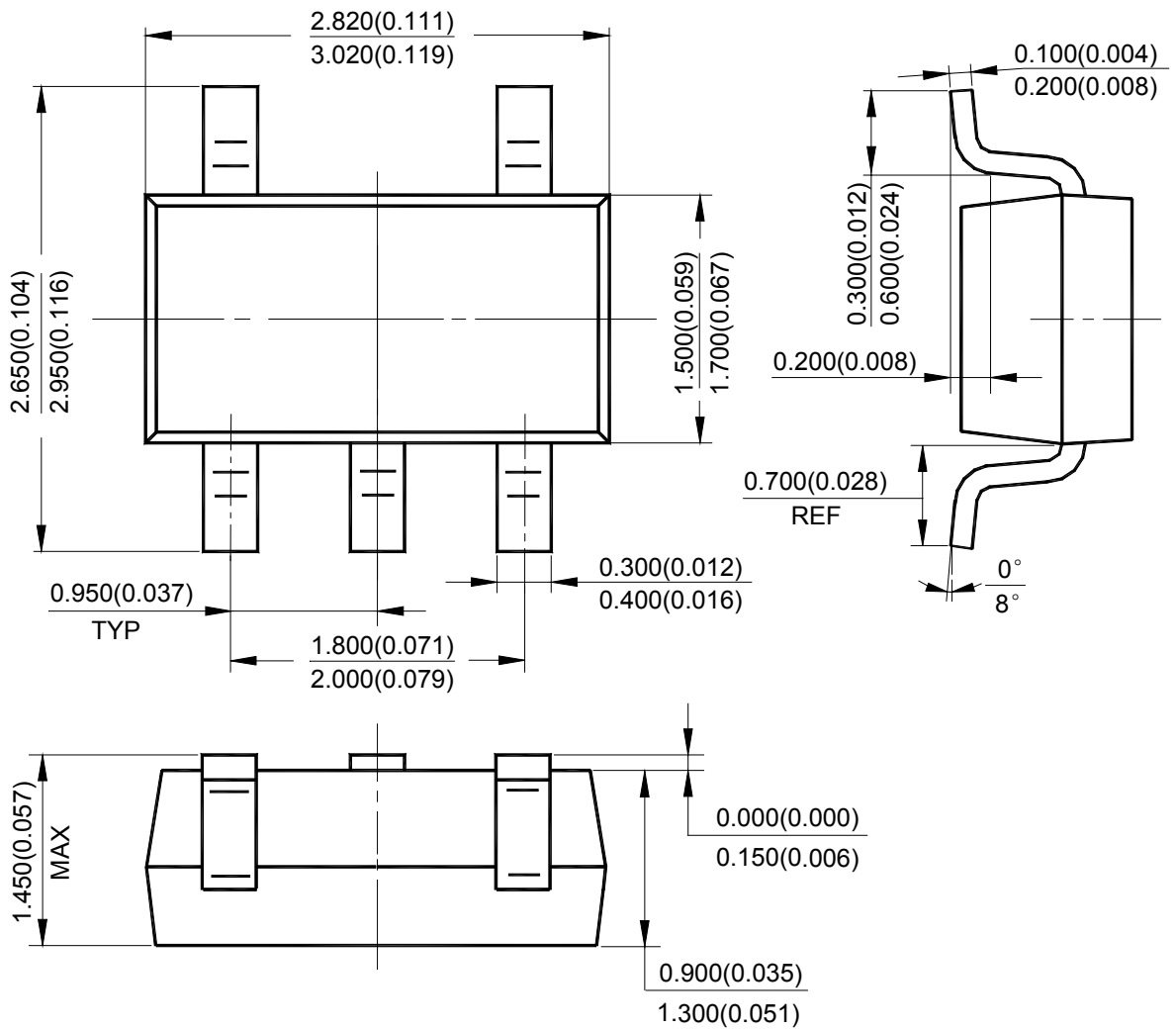



BCD Semiconductor Manufacturing Limited

<http://www.bcdsemi.com>

IMPORTANT NOTICE

BCD Semiconductor Manufacturing Limited reserves the right to make changes without further notice to any products or specifications herein. BCD Semiconductor Manufacturing Limited does not assume any responsibility for use of any its products for any particular purpose, nor does BCD Semiconductor Manufacturing Limited assume any liability arising out of the application or use of any its products or circuits. BCD Semiconductor Manufacturing Limited does not convey any license under its patent rights or other rights nor the rights of others.

MAIN SITE

- Headquarters

BCD Semiconductor Manufacturing Limited

No. 1600, Zi Xing Road, Shanghai ZiZhu Science-based Industrial Park, 200241, China
Tel: +86-21-24162266, Fax: +86-21-24162277

- Wafer Fab

Shanghai SIM-BCD Semiconductor Manufacturing Co., Ltd.

800 Yi Shan Road, Shanghai 200233, China
Tel: +86-21-6485 1491, Fax: +86-21-5450 0008

REGIONAL SALES OFFICE

Shenzhen Office

Shanghai SIM-BCD Semiconductor Manufacturing Co., Ltd., Shenzhen Office

Unit A Room 1203, Skyworth Bldg., Gaoxin Ave. 1.S., Nanshan District, Shenzhen, China
Tel: +86-755-8826 7951
Fax: +86-755-8826 7865

Taiwan Office

BCD Semiconductor (Taiwan) Company Limited

4F, 298-1, Rui Guang Road, Nei-Hu District, Taipei, Taiwan
Tel: +886-2-2656 2808
Fax: +886-2-2656 2806

USA Office

BCD Semiconductor Corp.

30920 Huntwood Ave. Hayward, CA 94544, USA
Tel : +1-510-324-2988
Fax: +1-510-324-2788

单击下面可查看定价，库存，交付和生命周期等信息

[>>Diodes Incorporated\(达达科技\(美台\)\)](#)