

DUAL COMPLEMENTARY PRE-BIASED TRANSISTOR IN SOT26

Features

- Epitaxial Planar Die Construction
- Built-In Biasing Resistors
- **Totally Lead-Free & Fully RoHS Compliant (Notes 1 & 2)**
- **Halogen and Antimony Free. "Green" Device (Note 3)**
- **For automotive applications requiring specific change control (i.e. parts qualified to AEC-Q100/101/200, PPAP capable, and manufactured in IATF 16949 certified facilities), please [contact us](mailto:contact@diodes.com) or your local Diodes representative.**

<https://www.diodes.com/quality/product-definitions/>

Part Number	R1	R2
DCX124EK	22kΩ	22kΩ
DCX144EK	47kΩ	47kΩ
DCX114YK	10kΩ	47kΩ
DCX123JK	2.2kΩ	47kΩ
DCX114EK	10kΩ	10kΩ
DCX115EK	100kΩ	100kΩ
DCX143TK	4.7kΩ	—
DCX114TK	10kΩ	—



SOT26

Mechanical Data

- Case: SOT26
- Surface Mount Package
- Case Material: Molded Plastic, UL Flammability Classification Rating 94V-0
- Terminals: Finish – Matte Tin Plated Leads, Solderable per MIL-STD-202, Method 208 Ⓔ3
- Weight: 0.016 grams (Approximate)

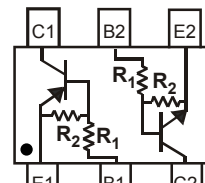

R1, R2 Device Schematic

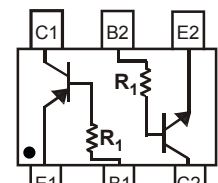

R1 only Device Schematic

Ordering Information (Note 4)

Part Number	Status	Compliance	Marking	Reel Size (inches)	Tape Width (mm)	Quantity per Reel
DCX124EK-7-F	Active	Standard	C17	7	8	3,000
DCX144EK-7	Obsolete	Standard	C20	7	8	3,000
DCX114YK-7-F	Obsolete	Standard	C14	7	8	3,000
DCX123JK-7	Obsolete	Standard	C06	7	8	3,000
DCX114EK-7	Obsolete	Standard	C13	7	8	3,000
DCX115EK-7-F	Active	Standard	C15	7	8	3,000
DCX143TK-7-F	Obsolete	Standard	C07	7	8	3,000
DCX114TK-7	Obsolete	Standard	C12	7	8	3,000

- Notes:
1. No purposely added lead. Fully EU Directive 2002/95/EC (RoHS), 2011/65/EU (RoHS 2) & 2015/863/EU (RoHS 3) compliant.
 2. See <https://www.diodes.com/quality/lead-free/> for more information about Diodes Incorporated's definitions of Halogen- and Antimony-free, "Green" and Lead-free.
 3. Halogen- and Antimony-free "Green" products are defined as those which contain <900ppm bromine, <900ppm chlorine (<1500ppm total Br + Cl) and <1000ppm antimony compounds.
 4. For packaging details, go to our website at <https://www.diodes.com/design/support/packaging/diodes-packaging/>.

Marking Information

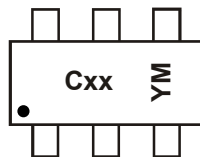

Cxx = Product Type Marking Code (See Page 1)
 YM = Date Code Marking
 Y = Year (ex: I = 2021)
 M = Month (ex: 9 = September)

Date Code Key

Year	2021	2022	2023	2024	2025	2026	2027	2028	2029	2030	2031	2032
Code	I	J	K	L	M	N	O	P	R	S	T	U

Month	Jan	Feb	Mar	Apr	May	Jun	Jul	Aug	Sep	Oct	Nov	Dec
Code	1	2	3	4	5	6	7	8	9	O	N	D

Maximum Ratings NPN Section @ T_A = 25°C unless otherwise specified

Characteristic		Symbol	Value	Unit
Supply Voltage		V _{CC}	50	V
Input Voltage	DCX124EK	V _{IN}	-10 to +40	V
	DCX144EK		-10 to +40	
	DCX114YK		-6 to +40	
	DCX123JK		-5 to +12	
	DCX114EK		-10 to +40	
	DCX115EK		-10 to +40	
	DCX143TK DCX114TK		-5V max -5V max	
Output Current	DCX124EK	I _O	30	mA
	DCX144EK		30	
	DCX114YK		70	
	DCX123JK		100	
	DCX114EK		50	
	DCX115EK		20	
	DCX143TK DCX114TK		100 100	
Output Current	All	I _{C(MAX)}	100	mA

Thermal Characteristics NPN Section

Characteristic	Symbol	Value	Unit
Power Dissipation (Total) (Note 5)	P _D	300	mW
Thermal Resistance, Junction to Ambient Air (Note 5)	R _{θJA}	417	°C/W
Operating and Storage Temperature Range	T _J , T _{STG}	-55 to +150	°C

Maximum Ratings PNP Section @ T_A = 25°C unless otherwise specified

Characteristic		Symbol	Value	Unit
Supply Voltage		V _{CC}	50	V
Input Voltage	DCX124EK	V _{IN}	+10 to -40	V
	DCX144EK		+10 to -40	
	DCX114YK		+6 to -40	
	DCX123JK		+5 to -12	
	DCX114EK		+10 to -40	
	DCX115EK		+10 to -40	
	DCX143TK DCX114TK		+5V max +5V max	
Output Current	DCX124EK	I _O	-30	mA
	DCX144EK		-30	
	DCX114YK		-70	
	DCX123JK		-100	
	DCX114EK		-50	
	DCX115EK		-20	
	DCX143TK DCX114TK		-100 -100	
Output Current	All	I _{C(MAX)}	-100	mA

Thermal Characteristics PNP Section

Characteristic	Symbol	Value	Unit
Power Dissipation (Total) (Note 5)	P _D	300	mW
Thermal Resistance, Junction to Ambient Air (Note 5)	R _{θJA}	417	°C/W
Operating and Storage Temperature Range	T _J , T _{STG}	-55 to +150	°C

Notes: 5. Mounted on FR-4 PC Board with minimum recommended pad layout.

Electrical Characteristics NPN Section (R1 only) @ T_A = 25°C unless otherwise specified

Characteristic (DDC143TK & DDC114TK only)	Symbol	Min	Typ	Max	Unit	Test Condition
Collector-Base Breakdown Voltage	BV _{CB0}	50	—	—	V	I _C = 50μA
Collector-Emitter Breakdown Voltage	BV _{CEO}	50	—	—	V	I _C = 1mA
Emitter-Base Breakdown Voltage	BV _{EBO}	5	—	—	V	I _E = 50μA
Collector Cut-Off Current	I _{CB0}	—	—	0.5	μA	V _{CB} = 50V
Emitter Cut-Off Current	I _{EBO}	—	—	0.5	μA	V _{EB} = 4V
Collector-Emitter Saturation Voltage	V _{CE(sat)}	—	—	0.3	V	I _C /I _B = 2.5mA / 0.25mA – DCX143TK I _C /I _B = 1mA / 0.1mA – DCX114TK
DC Current Transfer Ratio	h _{FE}	100	250	600	—	I _C = 1mA, V _{CE} = 5V
Input Resistor (R ₁) Tolerance	ΔR ₁	-30	—	+30	%	—
Transition frequency (Note 6)	f _T	—	250	—	MHz	V _{CE} = 10V, I _E = -5mA, f = 100MHz

Electrical Characteristics NPN Section (R1 & R2) (continued) @ T_A = 25°C unless otherwise specified

Characteristic	Symbol	Min	Typ	Max	Unit	Test Condition	
Input Voltage	V _{I(off)}	0.5	1.1	—	V	V _{CC} = 5V, I _O = 100μA	
		DCX124EK	0.5	1.1			
		DCX144EK	0.3	—			
		DCX114YK	0.5	—			
		DCX123JK	0.5	1.1			
		DCX114EK	0.5	1.1			
Input Voltage	V _{I(on)}	—	1.65	3.0	V	V _O = 0.3V, I _O = 5mA V _O = 0.3V, I _O = 2mA V _O = 0.3V, I _O = 1mA V _O = 0.3V, I _O = 5mA V _O = 0.3V, I _O = 10mA V _O = 0.3V, I _O = 1mA	
		DCX124EK	—	1.9			3.0
		DCX144EK	—	—			1.4
		DCX114YK	—	—			1.1
		DCX123JK	—	1.9			3.0
		DCX114EK	—	1.9			3.0
Output Voltage	V _{O(on)}	—	0.1	0.3	V	I _O /I _I = 10mA / 0.5mA I _O /I _I = 10mA / 0.5mA I _O /I _I = 5mA / 0.25mA I _O /I _I = 5mA / 0.25mA I _O /I _I = 10mA / 0.5mA I _O /I _I = 5mA / 0.25mA	
		DCX124EK	—	—			—
		DCX144EK	—	—			—
		DCX114YK	—	—			—
		DCX123JK	—	—			—
		DCX114EK	—	—			—
Input Current	I _I	—	—	0.36	mA	V _I = 5V	
		DCX124EK	—	—			0.18
		DCX144EK	—	—			0.88
		DCX114YK	—	—			3.6
		DCX123JK	—	—			0.88
		DCX114EK	—	—			0.15
Output Current	I _{O(off)}	—	—	0.5	μA	V _{CC} = 50V, V _I = 0V	
DC Current Gain	G _I	80	—	—	—	V _O = 5V, I _O = 5mA V _O = 5V, I _O = 5mA V _O = 5V, I _O = 10mA V _O = 5V, I _O = 10mA V _O = 5V, I _O = 5mA V _O = 5V, I _O = 5mA	
		DCX124EK	68	—			—
		DCX144EK	68	—			—
		DCX114YK	80	—			—
		DCX123JK	30	—			—
		DCX114EK	82	—			—
Input Resistor (R ₁) Tolerance	ΔR ₁	-30	—	+30	%	—	
Resistance Ratio Tolerance	R ₂ /R ₁	-20	—	+20	%	—	
Transition frequency (Note 6)	f _T	—	250	—	MHz	V _{CE} = 10V, I _E = -5mA, f = 100MHz	

Note: 6. Transistor - for reference only.

Electrical Characteristics PNP Section (R1 only) @ T_A = 25°C unless otherwise specified

Characteristic (DCX143TK & DCX114TK only)	Symbol	Min	Typ	Max	Unit	Test Condition
Collector-Base Breakdown Voltage	BV _{CBO}	-50	—	—	V	I _C = -50μA
Collector-Emitter Breakdown Voltage	BV _{CEO}	-50	—	—	V	I _C = -1mA
Emitter-Base Breakdown Voltage	BV _{EBO}	-5	—	—	V	I _E = -50μA
Collector Cut-Off Current	I _{CBO}	—	—	-0.5	μA	V _{CB} = -50V
Emitter Cut-Off Current	I _{EBO}	—	—	-0.5	μA	V _{EB} = -4V
Collector-Emitter Saturation Voltage	V _{CE(sat)}	—	—	-0.3	V	I _C /I _B = -2.5mA / -0.25mA - DCX143TK I _C /I _B = -1mA / -0.1mA - DCX114TK
DC Current Transfer Ratio	h _{FE}	100	250	600	—	I _C = -1mA, V _{CE} = -5V
Input Resistor (R ₁) Tolerance	ΔR ₁	-30	—	+30	%	—
Transition frequency (Note 6)	f _T	—	250	—	MHZ	V _{CE} = -10V, I _E = 5mA, f = 100MHZ

Electrical Characteristics PNP Section (R1 & R2) (continued) @ T_A = 25°C unless otherwise specified

Characteristic	Symbol	Min	Typ	Max	Unit	Test Condition	
Input Voltage	V _{I(off)}	DCX124EK	-0.5	-1.1	—	V	V _{CC} = -5V, I _O = -100μA
		DCX144EK	-0.5	-1.1	—		
		DCX114YK	-0.3	—	—		
		DCX123JK	-0.5	—	—		
		DCX114EK	-0.5	-1.1	—		
		DCX115EK	-0.5	-1.1	—		
Input Voltage	V _{I(on)}	DCX124EK	—	-1.9	-3.0	V	V _O = -0.3V, I _O = -5mA
		DCX144EK	—	-1.9	-3.0		
		DCX114YK	—	—	-1.4		
		DCX123JK	—	—	-1.1		
		DCX114EK	—	-1.9	-3.0		
		DCX115EK	—	-1.9	-3.0		
Output Voltage	V _{O(on)}	DCX124EK	—	-0.1	-0.3	V	I _O /I _I = -10mA / -0.5mA
		DCX144EK	—	-0.1	-0.3		
		DCX114YK	—	-0.1	-0.3		
		DCX123JK	—	-0.1	-0.3		
		DCX114EK	—	-0.1	-0.3		
		DCX115EK	—	-0.1	-0.3		
Input Current	I _I	DCX124EK	—	—	-0.36	mA	V _I = -5V
		DCX144EK	—	—	-0.18		
		DCX114YK	—	—	-0.88		
		DCX123JK	—	—	-3.6		
		DCX114EK	—	—	-0.88		
		DCX115EK	—	—	-0.15		
Output Current	I _{O(off)}	—	—	-0.5	μA	V _{CC} = 50V, V _I = 0V	
DC Current Gain	G _I	DCX124EK	80	—	—	—	V _O = -5V, I _O = -5mA
		DCX144EK	68	—	—		
		DCX114YK	68	—	—		
		DCX123JK	80	—	—		
		DCX114EK	30	—	—		
		DCX115EK	82	—	—		
Input Resistor (R ₁) Tolerance	ΔR ₁	-30	—	+30	%	—	
Resistance Ratio Tolerance	R ₂ /R ₁	-20	—	+20	%	—	
Transition Frequency (Note 6)	f _T	—	250	—	MHZ	V _{CE} = -10V, I _E = -5mA, f = 100MHZ	

Note: 6. Transistor - for reference only.

Typical Curves – Total Device

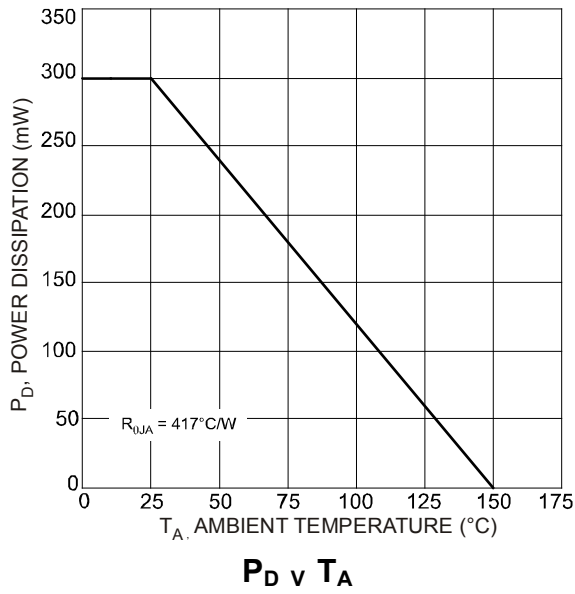

Typical Curves – DCX124EK PNP Section

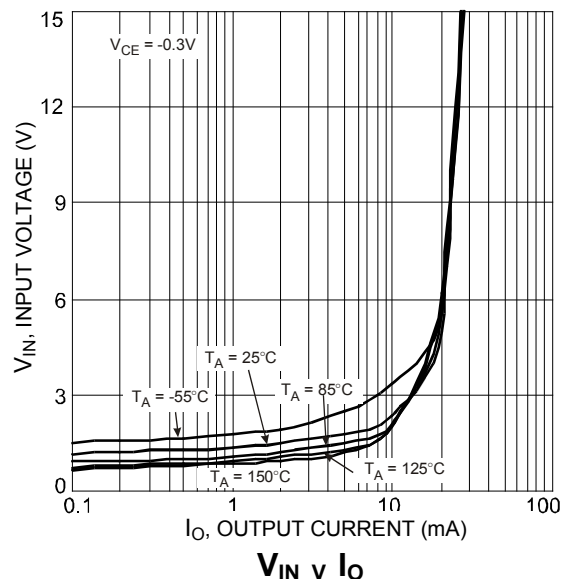
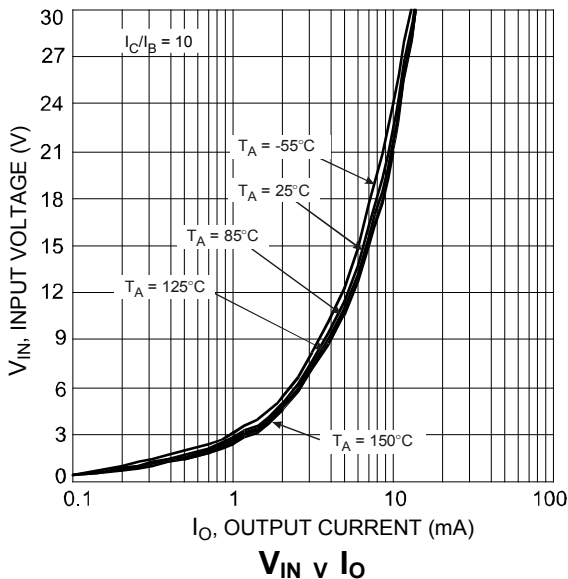
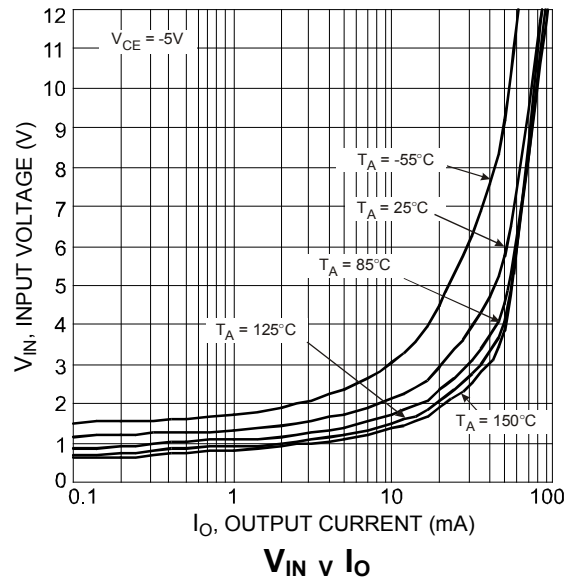
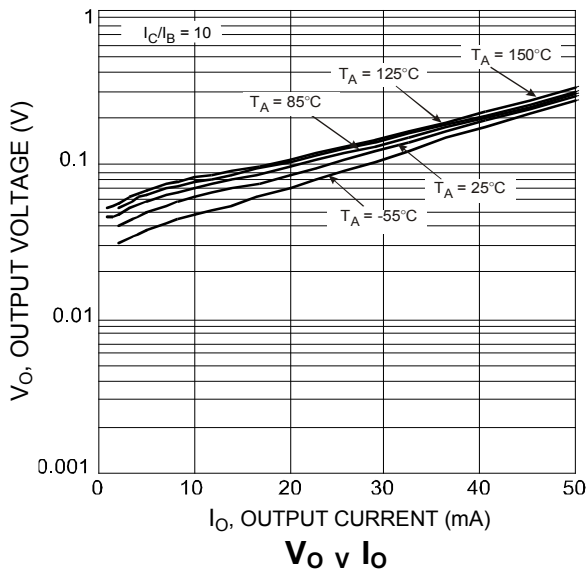
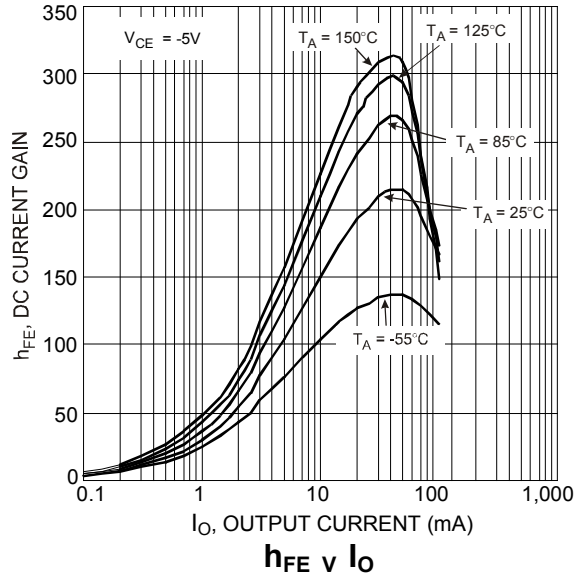
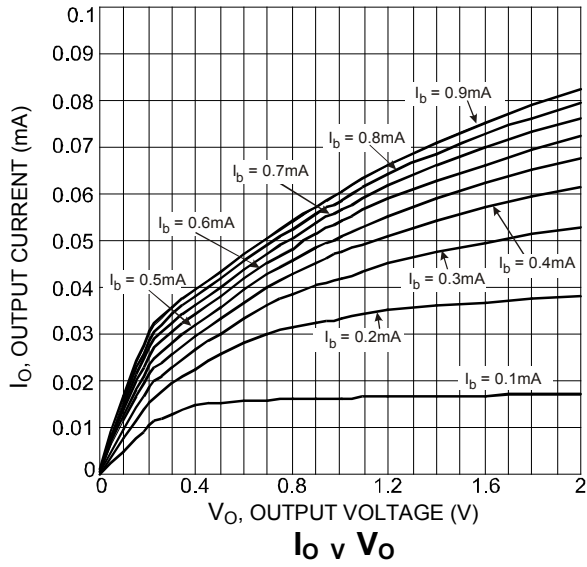

Typical Curves – DCX124EK NPN Section

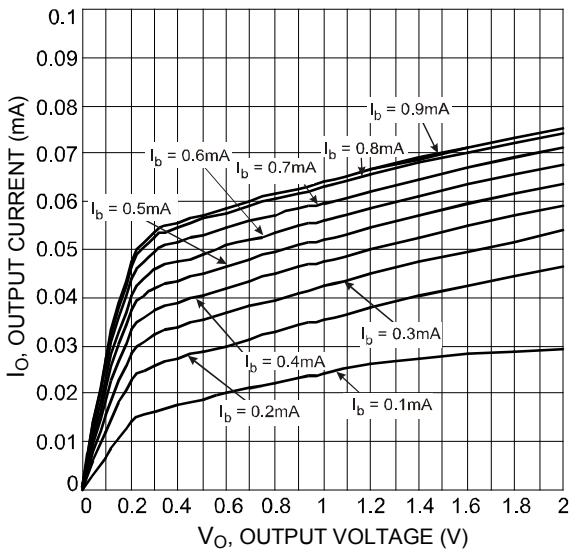

I_O v V_O

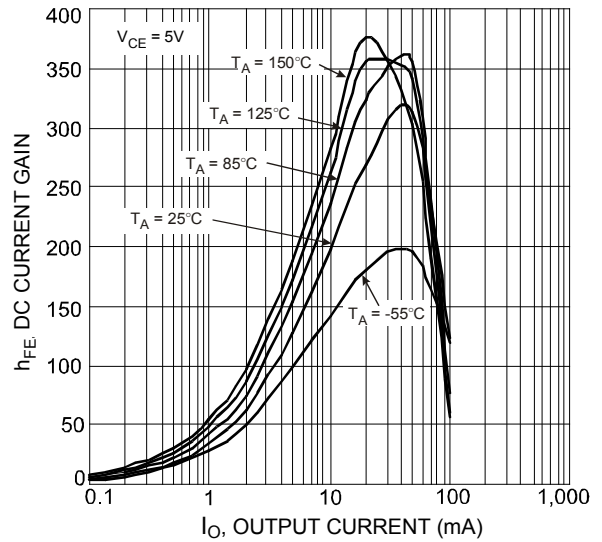

h_{FE} v I_O

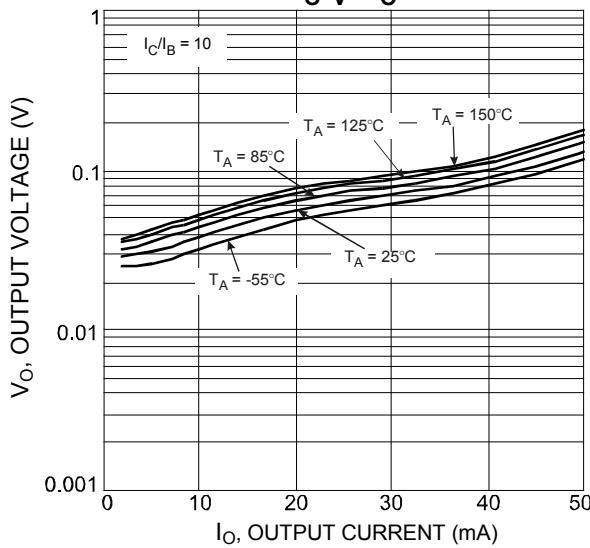

V_O v I_O

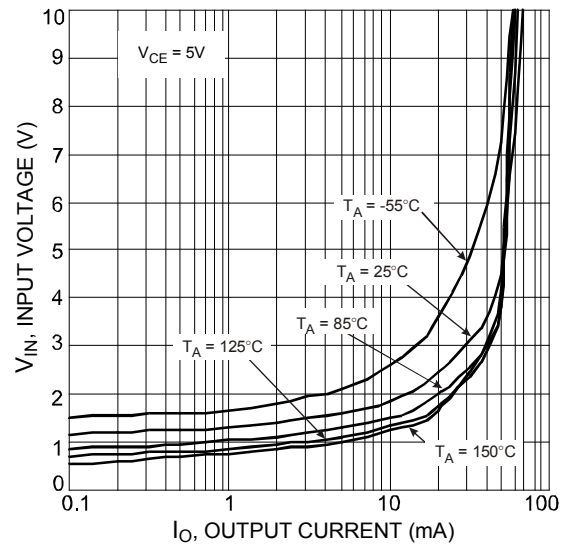

V_{IN} v I_O

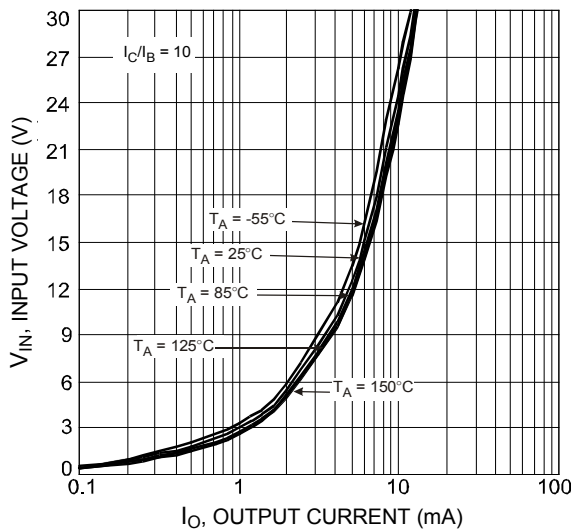

V_{IN} v I_O

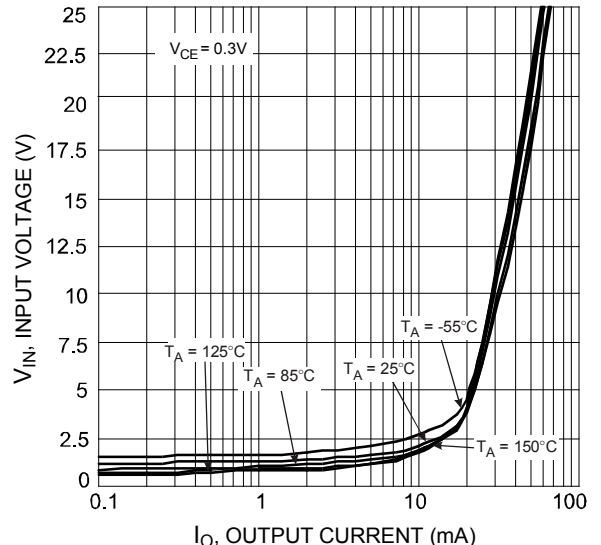

V_{IN} v I_O

Typical Curves – DCX123JK PNP Section

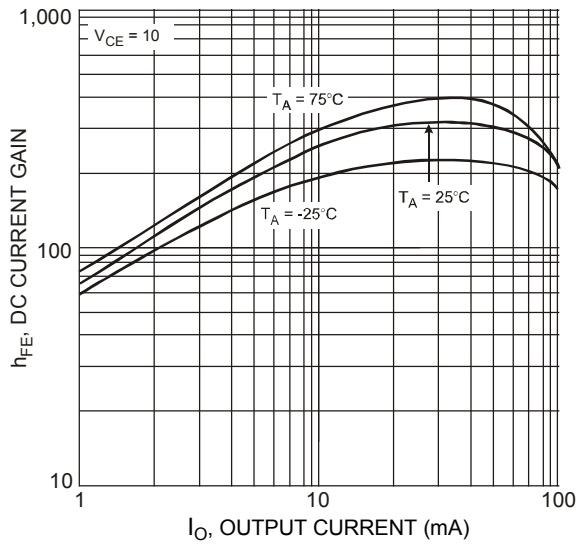

$h_{FE} \text{ v } I_O$

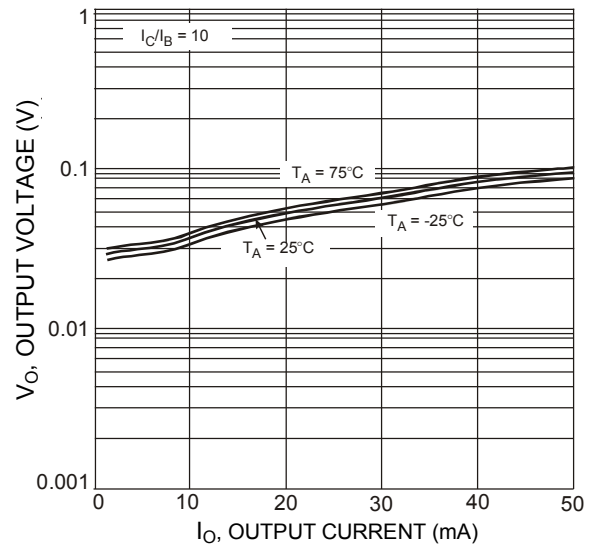

$V_O \text{ v } I_O$

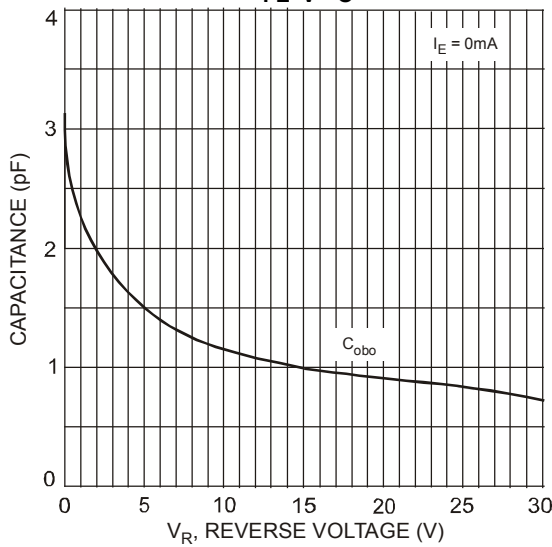

$C \text{ v } V_R$

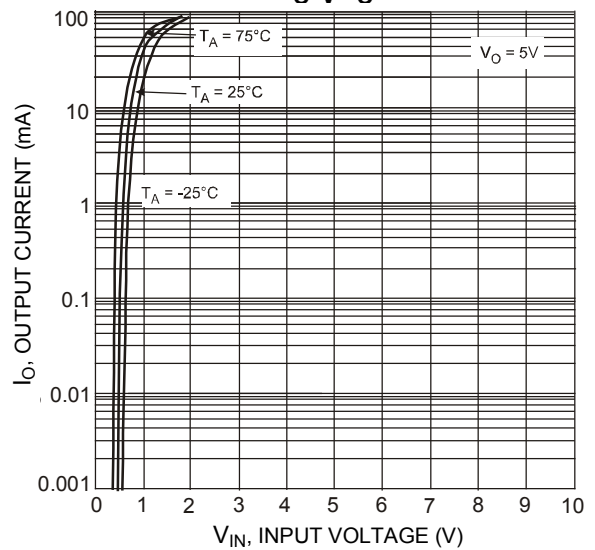

$I_O \text{ v } V_{IN}$

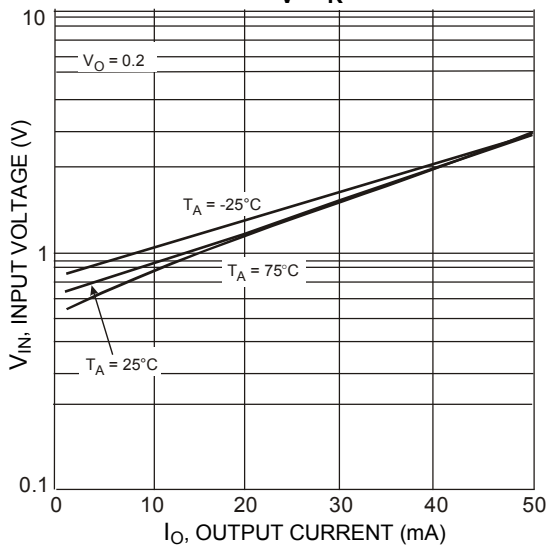

$V_{IN} \text{ v } I_O$

Typical Curves – DCX123JK NPN Section

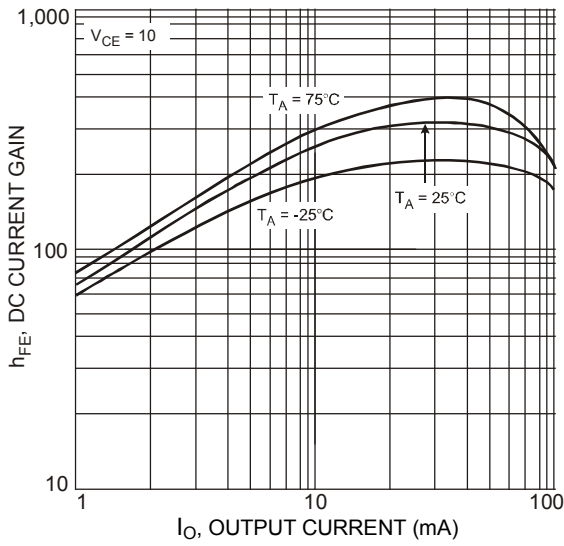

$h_{FE} \text{ v } I_O$

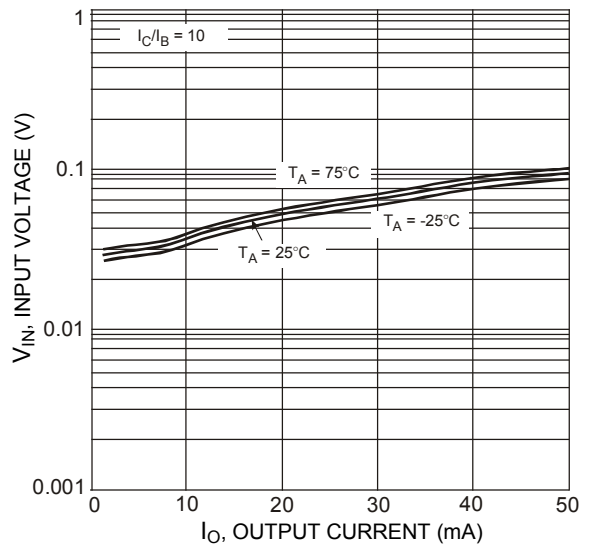

$V_{IN} \text{ v } I_O$

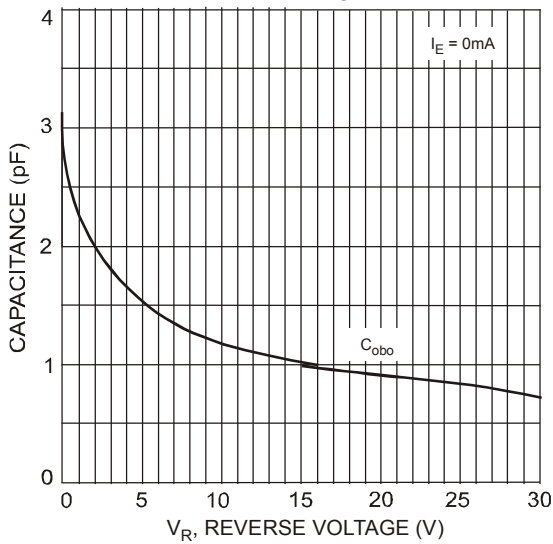

$C \text{ v } V_R$

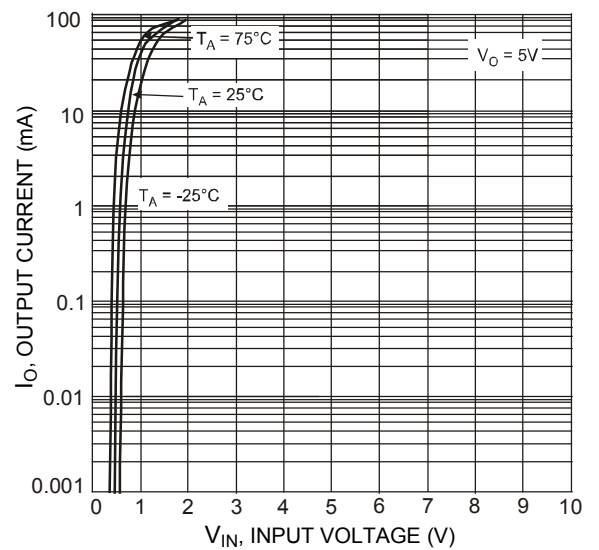

$I_O \text{ v } V_{IN}$

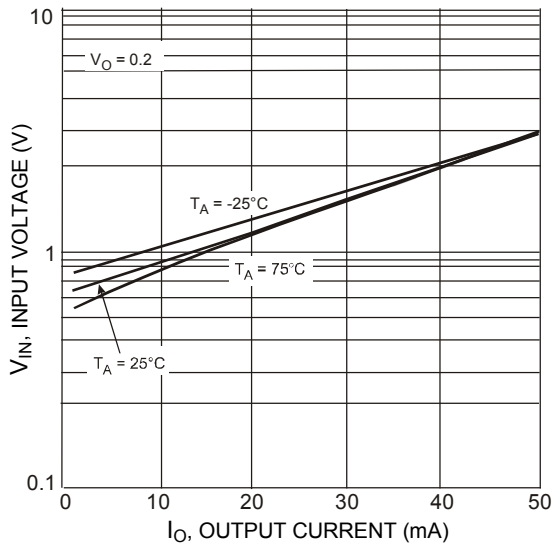

$V_{IN} \text{ v } I_O$

Typical Curves – DCX114TK PNP Section

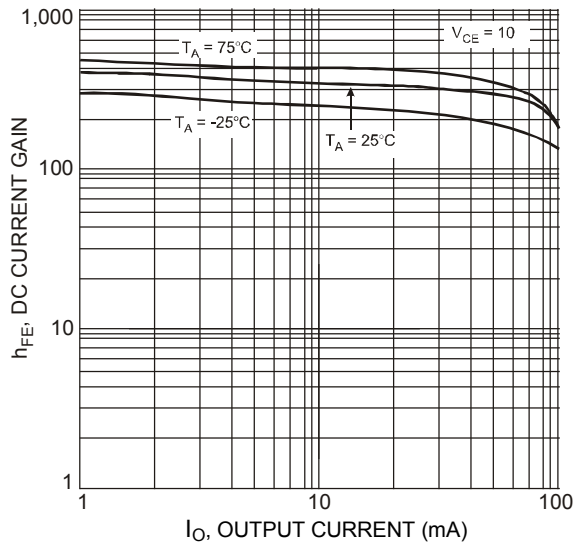

$h_{FE} \ v \ I_O$

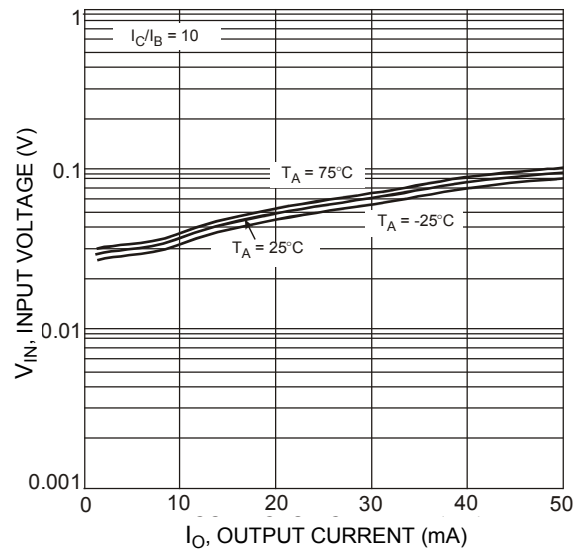

$V_{IN} \ v \ I_O$

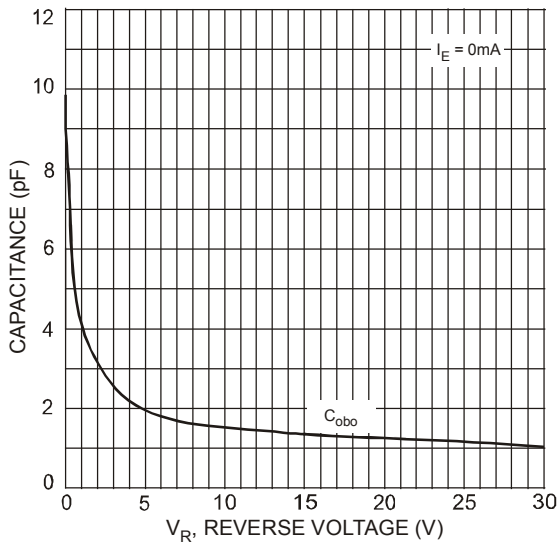

$C \ v \ V_R$

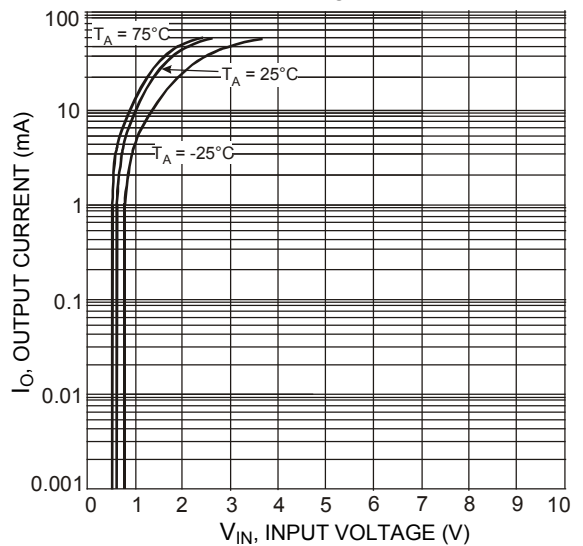

$I_O \ v \ V_{IN}$

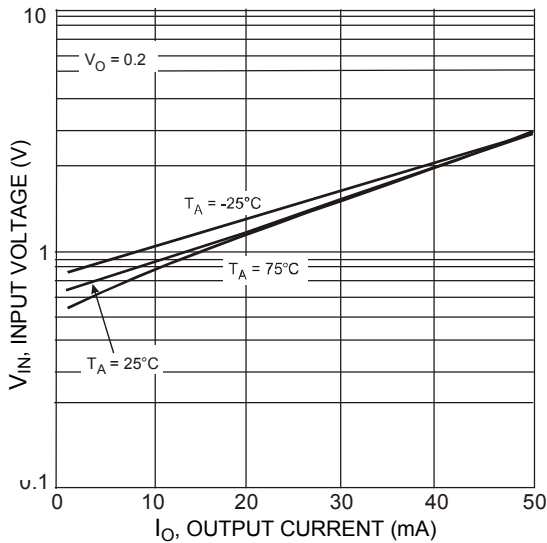

$V_{IN} \ v \ I_O$

Typical Curves- DCX114TK NPN Section

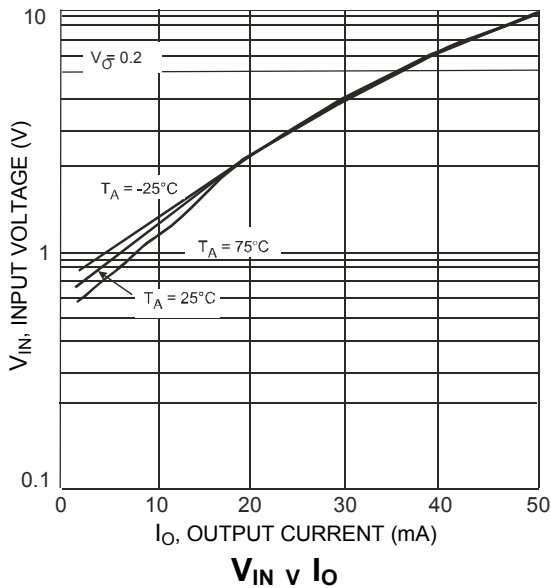
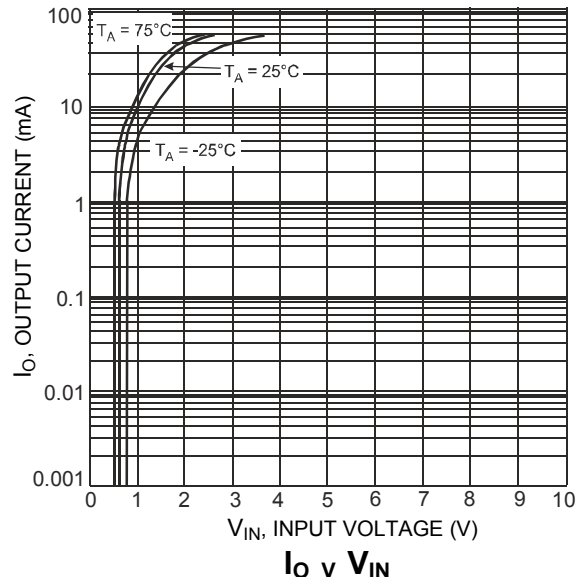
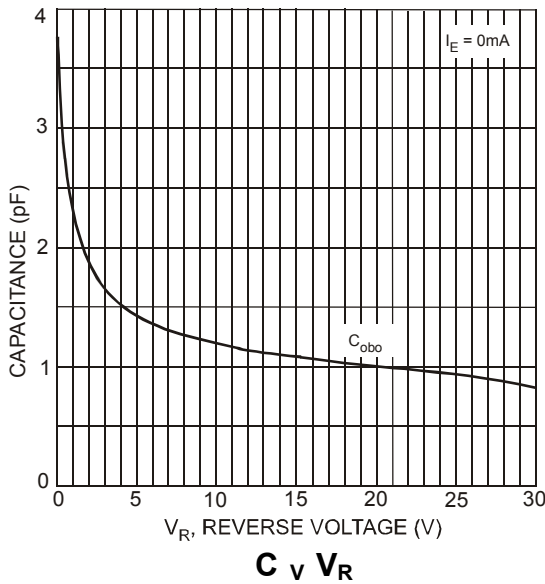
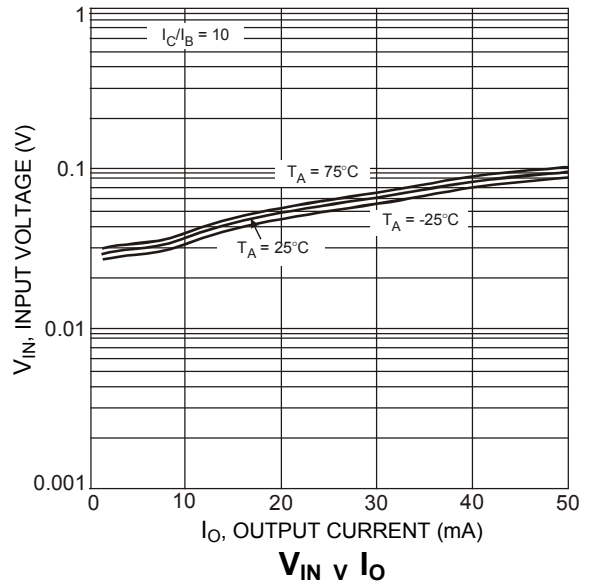
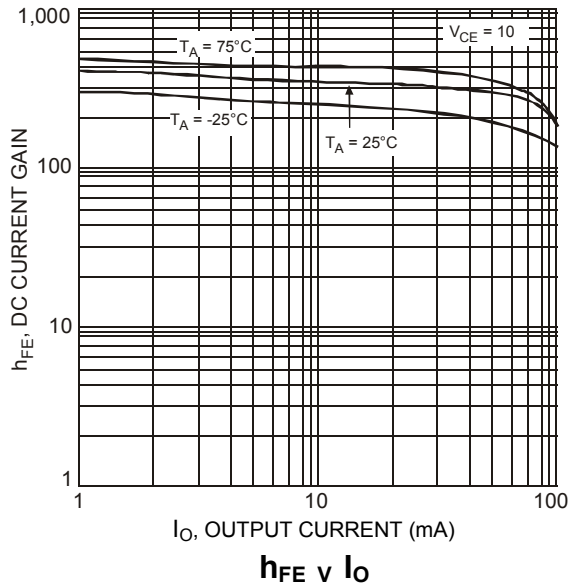

Package Outline Dimensions

Please see <http://www.diodes.com/package-outlines.html> for the latest version.

SOT26

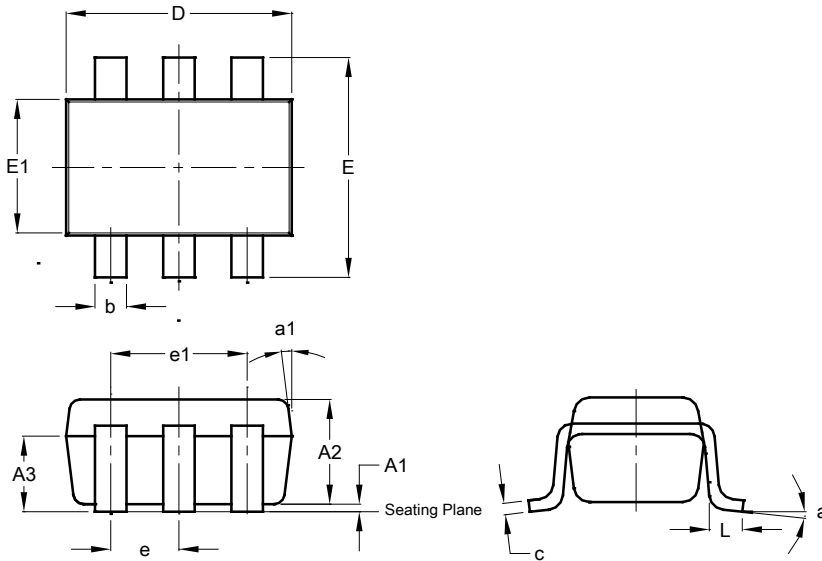

SOT26			
Dim	Min	Max	Typ
A1	0.013	0.10	0.05
A2	1.00	1.30	1.10
A3	0.70	0.80	0.75
b	0.35	0.50	0.38
c	0.10	0.20	0.15
D	2.90	3.10	3.00
e	-	-	0.95
e1	-	-	1.90
E	2.70	3.00	2.80
E1	1.50	1.70	1.60
L	0.35	0.55	0.40
a	-	-	8°
a1	-	-	7°

All Dimensions in mm

Suggested Pad Layout

Please see <http://www.diodes.com/package-outlines.html> for the latest version.

SOT26

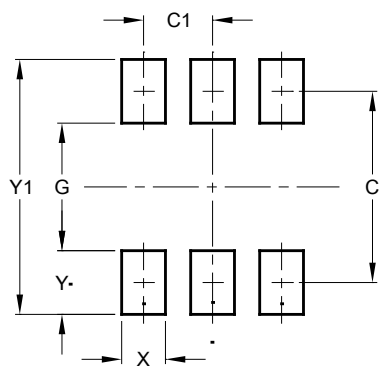

Dimensions	Value (in mm)
C	2.40
C1	0.95
G	1.60
X	0.55
Y	0.80
Y1	3.20

IMPORTANT NOTICE

1. DIODES INCORPORATED AND ITS SUBSIDIARIES ("DIODES") MAKE NO WARRANTY OF ANY KIND, EXPRESS OR IMPLIED, WITH REGARDS TO ANY INFORMATION CONTAINED IN THIS DOCUMENT, INCLUDING, BUT NOT LIMITED TO, THE IMPLIED WARRANTIES OF MERCHANTABILITY, FITNESS FOR A PARTICULAR PURPOSE OR NON-INFRINGEMENT OF THIRD PARTY INTELLECTUAL PROPERTY RIGHTS (AND THEIR EQUIVALENTS UNDER THE LAWS OF ANY JURISDICTION).
2. The Information contained herein is for informational purpose only and is provided only to illustrate the operation of Diodes products described herein and application examples. Diodes does not assume any liability arising out of the application or use of this document or any product described herein. This document is intended for skilled and technically trained engineering customers and users who design with Diodes products. Diodes products may be used to facilitate safety-related applications; however, in all instances customers and users are responsible for (a) selecting the appropriate Diodes products for their applications, (b) evaluating the suitability of the Diodes products for their intended applications, (c) ensuring their applications, which incorporate Diodes products, comply the applicable legal and regulatory requirements as well as safety and functional-safety related standards, and (d) ensuring they design with appropriate safeguards (including testing, validation, quality control techniques, redundancy, malfunction prevention, and appropriate treatment for aging degradation) to minimize the risks associated with their applications.
3. Diodes assumes no liability for any application-related information, support, assistance or feedback that may be provided by Diodes from time to time. Any customer or user of this document or products described herein will assume all risks and liabilities associated with such use, and will hold Diodes and all companies whose products are represented herein or on Diodes' websites, harmless against all damages and liabilities.
4. Products described herein may be covered by one or more United States, international or foreign patents and pending patent applications. Product names and markings noted herein may also be covered by one or more United States, international or foreign trademarks and trademark applications. Diodes does not convey any license under any of its intellectual property rights or the rights of any third parties (including third parties whose products and services may be described in this document or on Diodes' website) under this document.
5. Diodes products are provided subject to Diodes' Standard Terms and Conditions of Sale (<https://www.diodes.com/about/company/terms-and-conditions/terms-and-conditions-of-sales/>) or other applicable terms. This document does not alter or expand the applicable warranties provided by Diodes. Diodes does not warrant or accept any liability whatsoever in respect of any products purchased through unauthorized sales channel.
6. Diodes products and technology may not be used for or incorporated into any products or systems whose manufacture, use or sale is prohibited under any applicable laws and regulations. Should customers or users use Diodes products in contravention of any applicable laws or regulations, or for any unintended or unauthorized application, customers and users will (a) be solely responsible for any damages, losses or penalties arising in connection therewith or as a result thereof, and (b) indemnify and hold Diodes and its representatives and agents harmless against any and all claims, damages, expenses, and attorney fees arising out of, directly or indirectly, any claim relating to any noncompliance with the applicable laws and regulations, as well as any unintended or unauthorized application.
7. While efforts have been made to ensure the information contained in this document is accurate, complete and current, it may contain technical inaccuracies, omissions and typographical errors. Diodes does not warrant that information contained in this document is error-free and Diodes is under no obligation to update or otherwise correct this information. Notwithstanding the foregoing, Diodes reserves the right to make modifications, enhancements, improvements, corrections or other changes without further notice to this document and any product described herein. This document is written in English but may be translated into multiple languages for reference. Only the English version of this document is the final and determinative format released by Diodes.
8. Any unauthorized copying, modification, distribution, transmission, display or other use of this document (or any portion hereof) is prohibited. Diodes assumes no responsibility for any losses incurred by the customers or users or any third parties arising from any such unauthorized use.

Copyright © 2021 Diodes Incorporated

www.diodes.com

单击下面可查看定价，库存，交付和生命周期等信息

[>>Diodes Incorporated\(达达科技\(美台\)\)](#)