

Single Phase 2.0Amp Glass passivated Bridge Rectifiers

UMSB

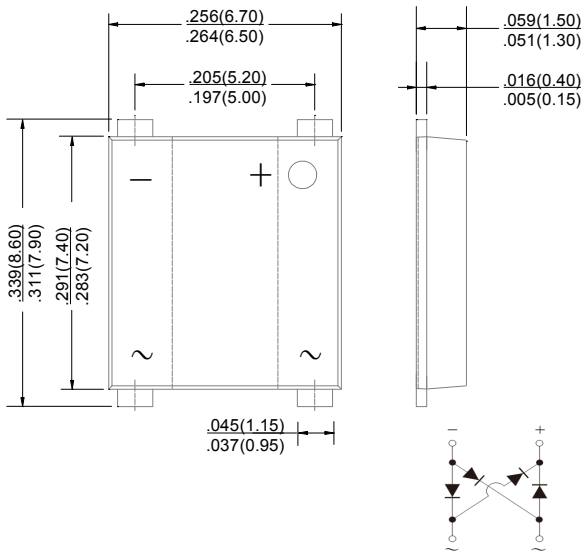

Dimensions in inches and (millimeters)

Features

- ◆ The plastic package carries Underwriters Laboratory Flammability Classification 94V-0
- ◆ Idea for printed circuit board
- ◆ Glass passivated junction chip
- ◆ Low reverse leakage
- ◆ High forward surge current capability
- ◆ High temperature soldering guaranteed
260°C/10 seconds at terminals

Mechanical Data

Case : Molded plastic body

Terminals : Solder plated, solderable per MIL-STD-750, Method 2026

Polarity : Polarity symbol marking on body

Mounting Position : Any

Maximum Ratings And Electrical Characteristics

Ratings at 25°C ambient temperature unless otherwise specified. Single phase half-wave 60Hz, resistive or inductive load, for capacitive load current derate by 20%.

| Parameter | SYMBOLS | MSB20A | MSB20B | MSB20D | MSB20G | MSB20J | MSB20K | MSB20M | UNITS |
|---|-----------------|-------------|--------|--------|--------|--------|--------|--------|----------------------|
| Maximum repetitive peak reverse voltage | V_{RRM} | 50 | 100 | 200 | 400 | 600 | 800 | 1000 | V |
| Maximum RMS voltage | V_{RMS} | 35 | 70 | 140 | 280 | 420 | 560 | 700 | V |
| Maximum DC blocking voltage | V_{DC} | 50 | 100 | 200 | 400 | 600 | 800 | 1000 | V |
| Maximum average forward rectified current at $T_L=100^\circ\text{C}$ | $I_{(AV)}$ | 2.0 | | | | | | | A |
| Peak forward surge current, 8.3ms single half sine-wave superimposed on rated load | I_{FSM} | 50.0 | | | | | | | A |
| Rating for fusing ($t=8.3\text{ms}$, $T_a=25^\circ\text{C}$) | I_t^2 | 10.3 | | | | | | | A^2s |
| Maximum instantaneous forward voltage at 2.0A | V_F | 1.0 | | | | | | | V |
| Maximum DC reverse current $T_A=25^\circ\text{C}$ at rated DC blocking voltage $T_A=125^\circ\text{C}$ | I_R | 2.0 200 | | | | | | | μA |
| Typical junction capacitance (Note 1) | C_J | 18.0 | | | | | | | pF |
| Typical thermal resistance | $R_{\theta JA}$ | 55.0 | | | | | | | $^\circ\text{C/W}$ |
| Operating junction and storage temperature range | T_J, T_{STG} | -55 to +150 | | | | | | | $^\circ\text{C}$ |

Note: 1. Measured at 1MHz and applied reverse voltage of 4.0V D.C.

Ratings And Characteristic Curves

FIG. 1- DERATING CURVE OUTPUT RECTIFIED CURRENT

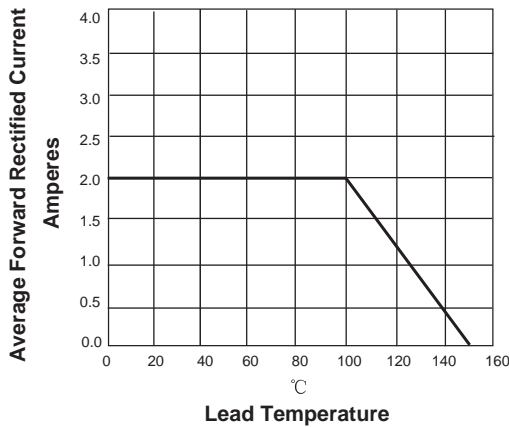

FIG. 2-MAXIMUM NON-REPETITIVE PEAK FORWARD SURGE CURRENT PER LEG

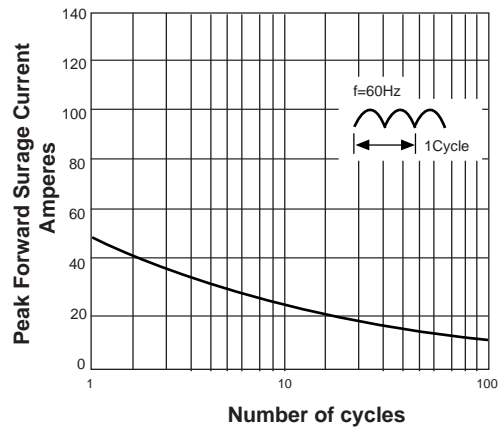

FIG. 3-TYPICAL FORWARD VOLTAGE CHARACTERISTICS

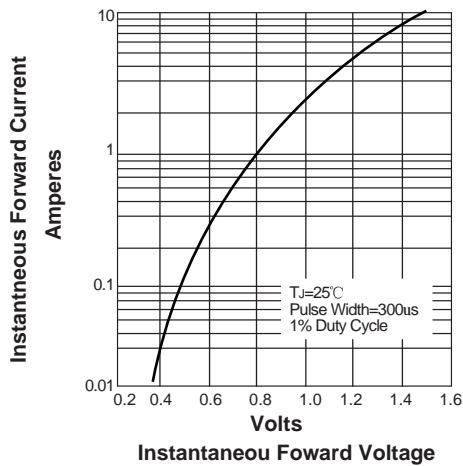
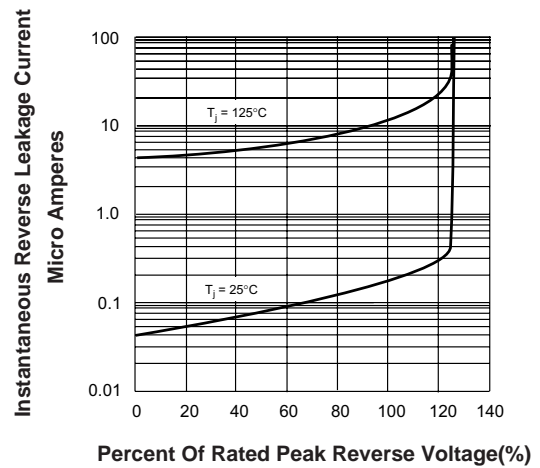
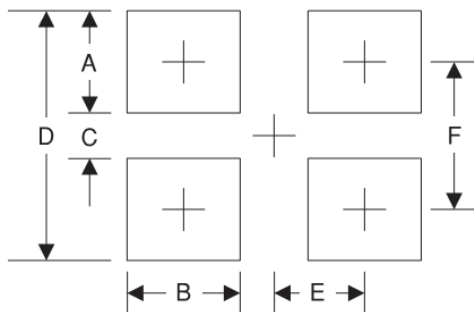

FIG. 4-TYPICAL REVERSE LEAKAGE CHARACTERISTICS



Suggested Pad Layout



| Symbol | Unit (mm) | Unit (inch) |
|--------|-----------|-------------|
| A | 1.8 | 0.071 |
| B | 2.0 | 0.078 |
| C | 5.50 | 0.216 |
| D | 9.15 | 0.360 |
| E | 2.6 | 0.102 |
| F | 7.35 | 0.289 |

Marking

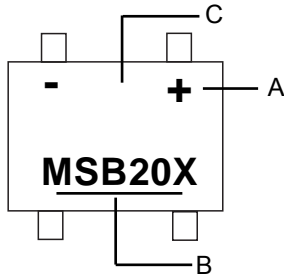

| Symbol | Explanation |
|--------|-----------------------------|
| A | Polarity Symbol |
| B | Product Name, X : 1.2.....7 |
| C | Logo |

Suggested Soldering Temperature Profile

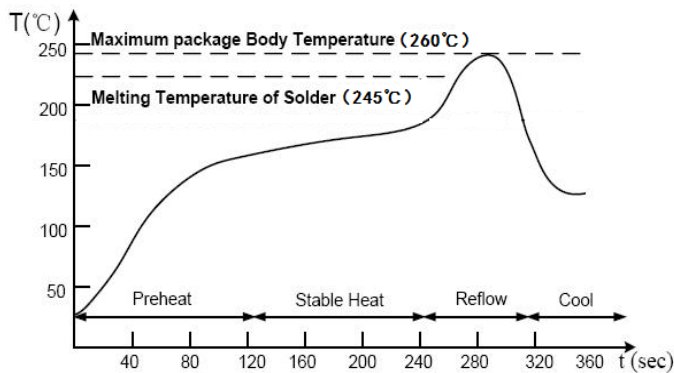

Note

- Recommended reflow methods: IR, vapor phase oven, hot air oven, wave solder.
- The device can be exposed to a maximum temperature of 260°C for 10 seconds.
- Devices can be cleaned using standard industry methods and solvents.
- If reflow temperatures exceed the recommended profile, devices may not meet the performance requirements.

Package Information

Carrier Dimension(mm)

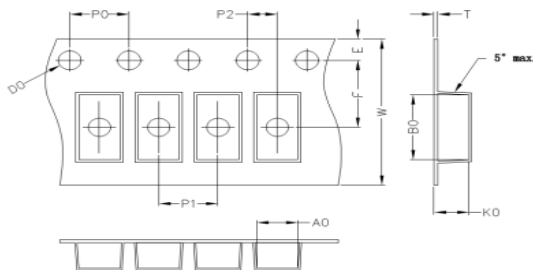

| | | | | | |
|-----------|-----------|-----------|-----------|----------|------------------|
| A0 | B0 | K0 | D0 | E | F |
| 6.90 | 8.60 | 1.65 | 1.55 | 1.75 | 7.50 |
| P0 | P1 | P2 | T | W | Tolerance |
| 4.0 | 12.0 | 2.0 | 0.30 | 16 | 0.1 |

Package Specifications

| Package | Reel Size | Reel DIA. (mm) | Q'TY/Reel (Kpcs) | Box Size (mm) | QTY/Box (Kpcs) | Carton Size (mm) | Q'TY/Carton (Kpcs) |
|---------|-----------|----------------|------------------|---------------|----------------|------------------|--------------------|
| MSB | 13' | 330 | 3 | 338 | 6 | 365*365*360 | 48 |

单击下面可查看定价，库存，交付和生命周期等信息

[>>DIOS\(迪恩思\)](#)