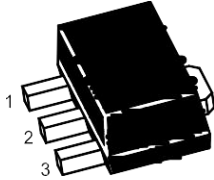

TRANSISTOR(NPN)	SOT-89 Plastic-Encapsulate Transistors
<p><u>SOT-89</u></p>  <p>1.Base 2.Collector 3.Emitter SOT-89 Plastic Package</p>	<p style="text-align: center;">Features</p> <ul style="list-style-type: none"> Compliment to SS8550

MAXIMUM RATINGS (T_a=25°C unless otherwise noted)

Symbol	Parameter	Value	Unit
V _{CB0}	Collector-Base Voltage	40	V
V _{CEO}	Collector-Emitter Voltage	25	V
V _{EBO}	Emitter-Base Voltage	5	V
I _c	Collector Current -Continuous	1.5	A
P _c	Collector Power dissipation	0.5	W
R _{θJA}	Thermal Resistance From Junction To Ambient	250	°C/W
T _J	Storage Temperature	150	°C
T _{stg}	Storage Temperature	-55~150	°C

ELECTRICAL CHARACTERISTICS (T_a=25°C unless otherwise specified)

Parameter	Symbol	Test conditions	Min	Typ	Max	Unit
Collector-base breakdown voltage	V _{(BR)CBO}	I _c =100μA, I _E =0	40			V
Collector-emitter breakdown voltage	V _{(BR)CEO}	I _c =0.1mA, I _B =0	25			V
Emitter-base breakdown voltage	V _{(BR)EBO}	I _E =100μA, I _c =0	5			V
Collector cut-off current	I _{CB0}	V _{CB} =40V, I _E =0			0.1	μA
Emitter cut-off current	I _{CEO}	V _{CE} =20V, I _E =0			0.1	μA
Emitter cut-off current	I _{EBO}	V _{EB} =5V, I _c =0			0.1	μA
DC current gain	h _{FE(1)}	V _{CE} =1V, I _c =100mA	120		400	
	h _{FE(2)}	V _{CE} =1V, I _c =800mA	40			
Collector-emitter saturation voltage	V _{CE(sat)}	I _c =800mA, I _B =80mA			0.5	V
Base-emitter saturation voltage	V _{BE(sat)}	I _c =800mA, I _B =80mA			1.2	V
Base-emitter voltage	V _{BE}	V _{CE} =1V, I _c =10mA			1	V
Base-emitter positive favor voltage	V _{BEF}	I _B =1A			1.55	V
Transition frequency	f _T	V _{CE} =10V, I _c =50mA, f=30MHz	100			MHz
output capacitance	C _{ob}	V _{CB} =10V, I _E =0, f=1MHz			15	pF

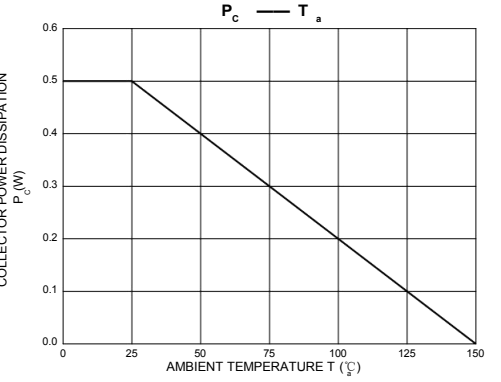
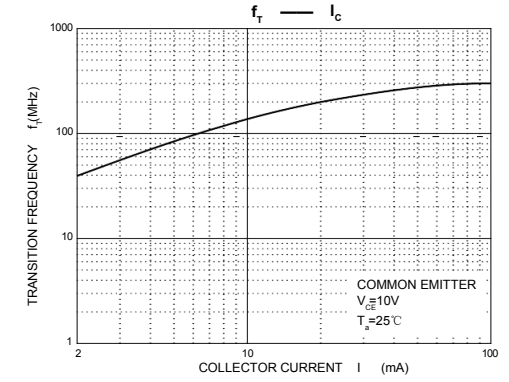
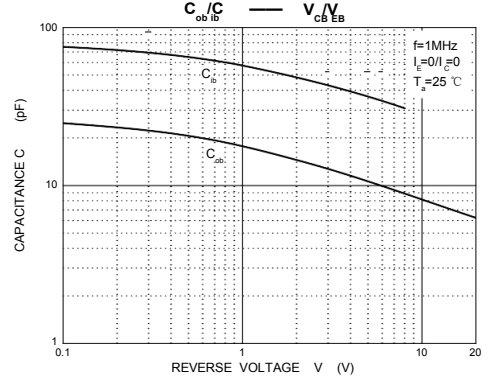
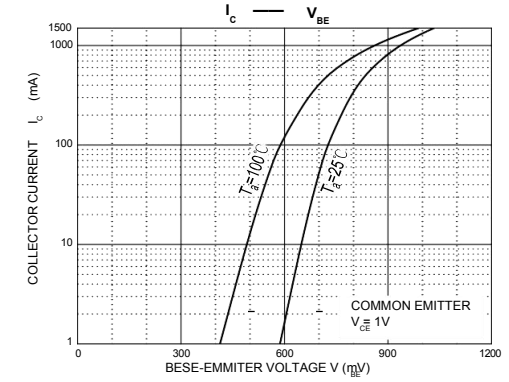
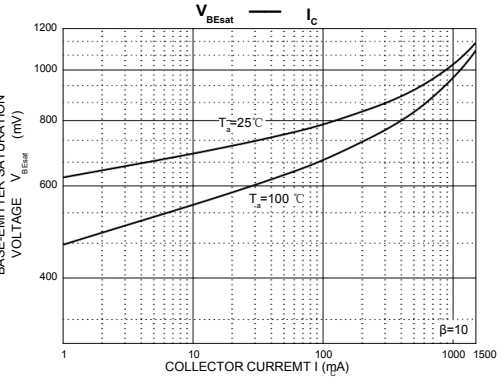
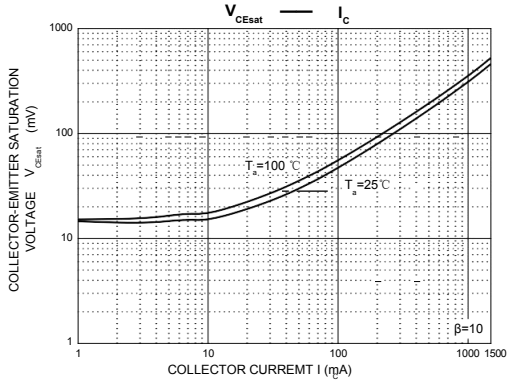
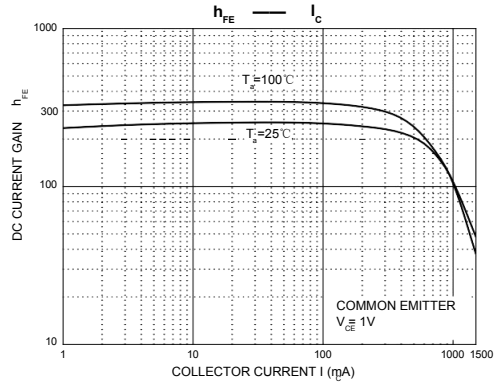
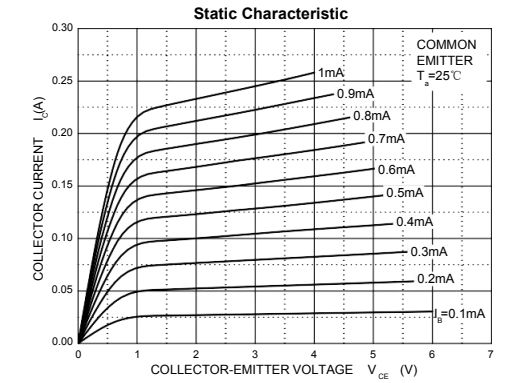

SS8050

SOT-89 PACKAGE OUTLINE

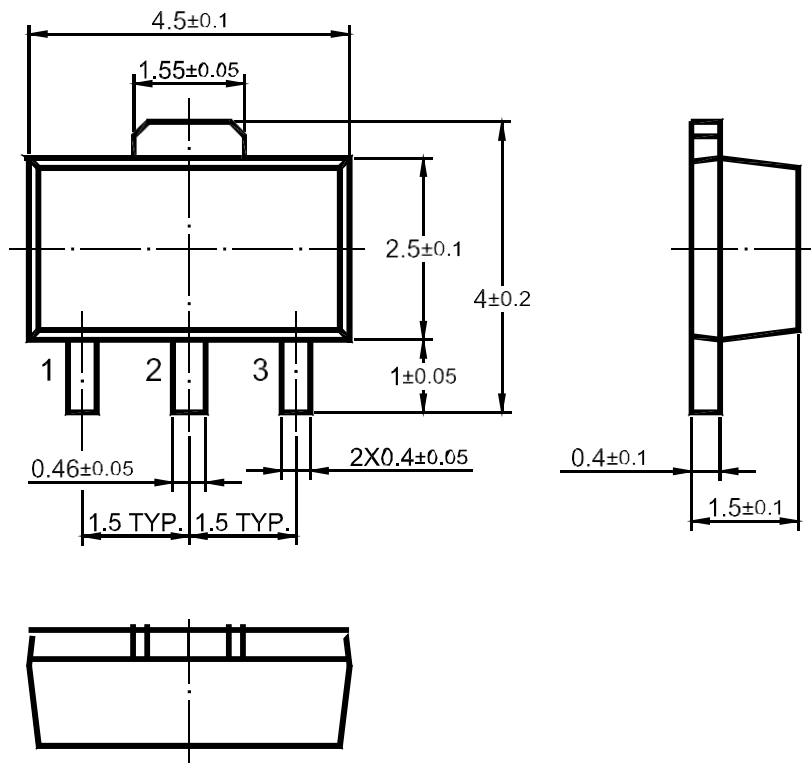

Dimensions in mm

单击下面可查看定价，库存，交付和生命周期等信息

[>>DIOS\(迪恩思\)](#)