

SILICON EPITAXIAL PLANAR SCHOTTKY BARRIER DIODE

SOD-523

PIN	DESCRIPTION
1	Cathode
2	Anode

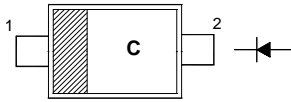

Top View
Marking Code: "C"
Simplified outline SOD-523 and symbol

Features

- Extremely small surface mounting type

Absolute Maximum Ratings ($T_a = 25\text{ }^\circ\text{C}$)

Parameter	Symbol	Value	Unit
Reverse Voltage	V_R	30	V
Mean Rectifying Current	I_O	200	mA
Peak Forward Surge Current (60Hz for Cyc.)	I_{FSM}	1	A
Junction Temperature	T_j	125	$^\circ\text{C}$
Storage Temperature Range	T_{stg}	- 40 to + 125	$^\circ\text{C}$

Characteristics at $T_a = 25\text{ }^\circ\text{C}$

Parameter	Symbol	Max.	Unit
Forward Voltage at $I_F = 200\text{ mA}$	V_F	0.5	V
Reverse Current at $V_R = 10\text{ V}$	I_R	30	μA

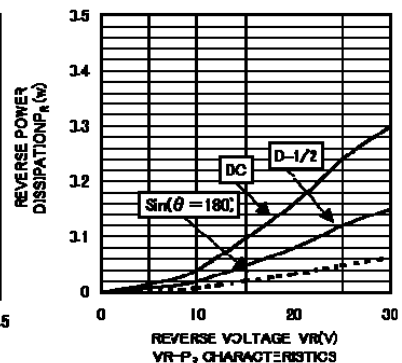
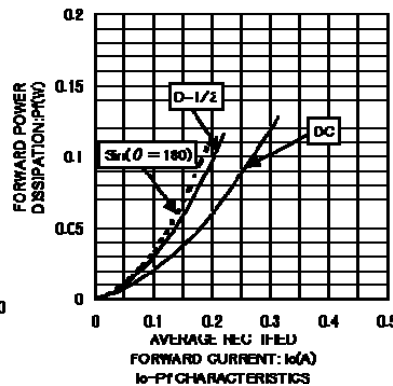
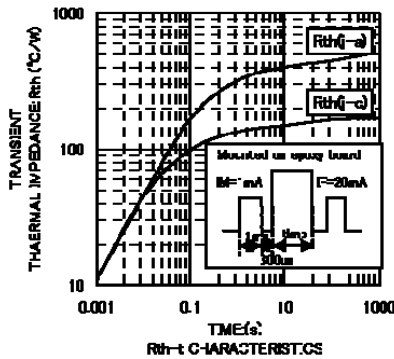
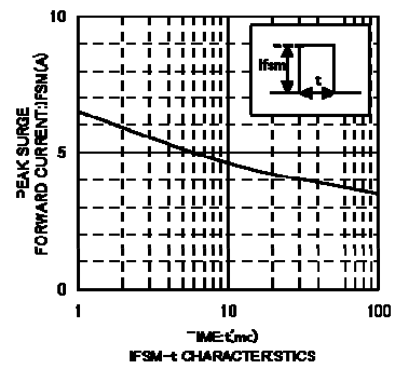
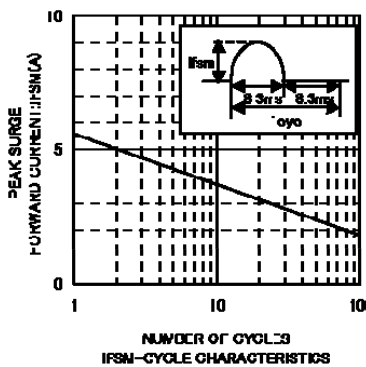
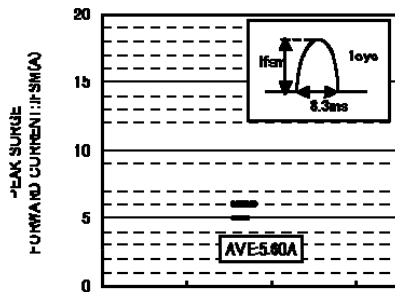
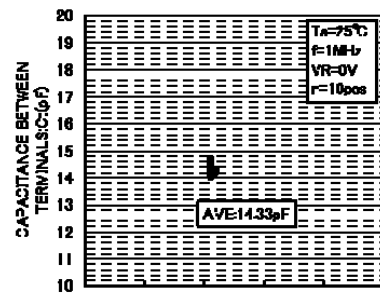
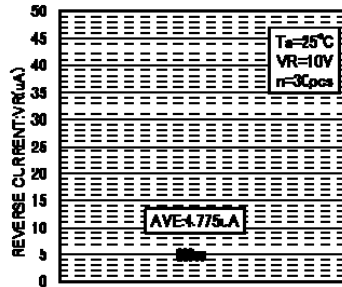
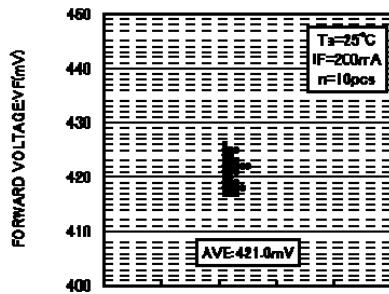
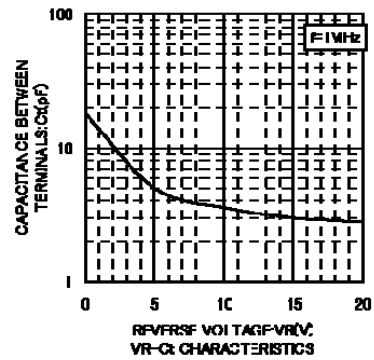
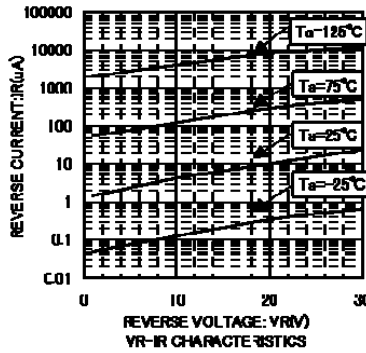
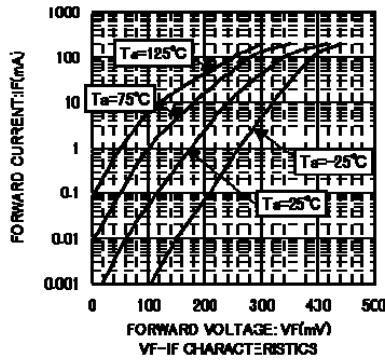

PACKAGE OUTLINE

Plastic surface mounted package; 2 leads

SOD-523

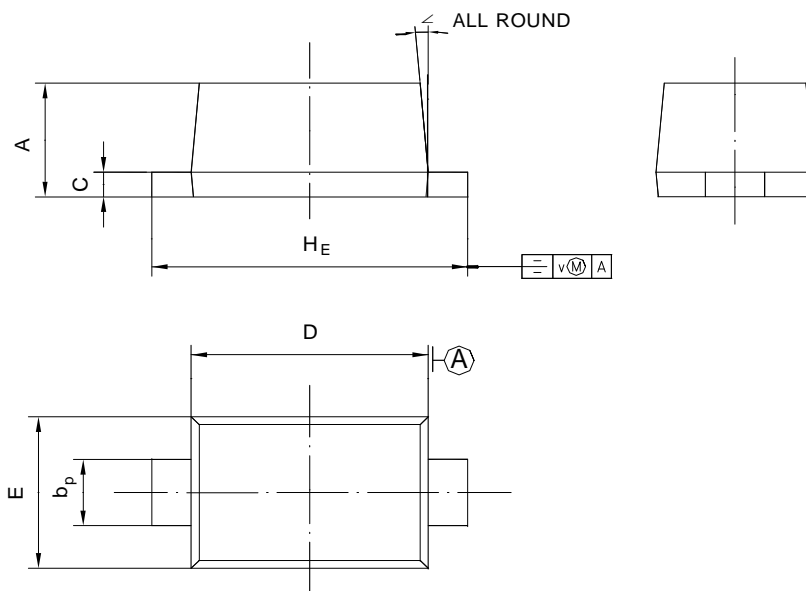

UNIT	A	b _p	C	D	E	H _E	V	∠
mm	0.70 0.60	0.4 0.3	0.135 0.100	1.25 1.15	0.85 0.75	1.7 1.5	0.1	5°

单击下面可查看定价，库存，交付和生命周期等信息

[>>DIOS\(迪恩思\)](#)