

4PIN MINI FLAT PACKAGE SOLID STATE RELAY ELM4XXA SERIES

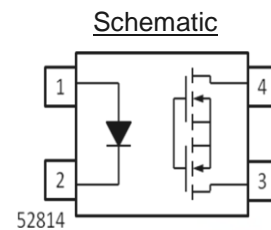
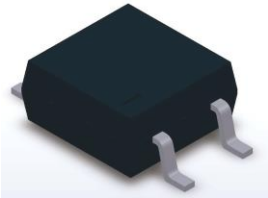

Pin Configuration

- 1, LED Anode
- 2, LED Cathode
- 3, 4, MOSFET

Features

- Compliance Halogen Free(Br < 900ppm, Cl < 900ppm, Br+Cl < 1500ppm)
- Normally open signal pole signal throw relay
- Small 4pin SOP package in the 400V & 600V load voltage series
- Lower operation current
- Low-level off state leakage current
- Low on resistance
- Compliance with EU REACH
- Pb free and RoHS compliant
- UL and cUL (approved)
- VDE (approved)
- SEMKO (approved)
- NEMKO (approved)
- FIMKO (approved)
- CQC (approved)

Description

The ELM4XXA is solid state relays containing an AlGaAs infrared LEDs on the light emitting side (input side) optically coupled to a high voltage output detector circuit. The detector consists of a photovoltaic diode array and MOSFETs on the output side. The single channel configuration is equivalent to 1 form A EMR. The devices in a 4-pin small outline SMD package

Applications

- Exchange equipment
- Measurement and testing equipment
- FA/OA equipment
- Industrial controls
- Security

Absolute Maximum Ratings ($T_A=25^{\circ}\text{C}$, unless otherwise specified)

Parameter	Symbol	Rating		Unit	
		ELM440A	ELM460A		
Input	Forward Current	I_F	50	mA	
	Reverse Voltage	V_R	5	V	
	Peak Forward Current* ¹	I_{FP}	1	A	
	Power Dissipation	P_{in}	75	mW	
Output	Break Down Voltage	V_L	400	600	V
	Continuous Load Current	I_L	120	50	mA
	Pulse Load Current* ²	I_{LPeak}	0.3	0.15	A
	Power Dissipation	P_{out}	500		mW
Total Power Dissipation	P_T	550		mW	
Isolation Voltage* ³	V_{iso}	3750		Vrms	
Storage Temperature	T_{STG}	-40 to 125		$^{\circ}\text{C}$	
Operating Temperature	T_{OPR}	-40 to 85		$^{\circ}\text{C}$	
Soldering Temperature* ⁴	T_{SOL}	260		$^{\circ}\text{C}$	

Notes:

*1. $f=100\text{Hz}$, Duty Cycle = 0.1%

*2. A connection: 100ms (1 shot), $V_L = \text{DC}$

*3. AC for 1 minute, R.H. = 40 ~ 60% R.H. In this test, pins 1, 2 are shorted together, and pins 3, 4 are shorted together.

*4. For 10 seconds

Electro-Optical Characteristics (T_A=25 °C)

	Parameter	Symbol	Condition	Min.	Typ.	Max.	Unit	
Input	Forward Voltage	V _F	I _F = 10mA	-	1.18	1.5	V	
	Reverse Current	I _R	V _R = 5V	-	-	1	μA	
Output	Off State leakage Current	I _{leak}	I _F = 0mA, V _L = Max.	-	-	1	μA	
	On Resistance	ELM440A	I _F = 10mA, I _L = Max. t = 1s	-	20	30	Ω	
		ELM460A			40	70		
	Output Capacitance	ELM440A	C _{out}	V _L = 0V, f = 1MHz	-	45	-	pF
ELM460A					30			
Transfer Characteristics	LED turn on Current	ELM440A	I _{F(on)}	I _L = Max.	-	1	5	mA
		ELM460A						
	LED turn off current	ELM440A ELM460A	I _{F(off)}	I _L = 1μA	0.2	0.6	-	mA
	Turn On Time	ELM440A	T _{on}	I _F = 10 mA, I _L = MAX. R _L = 200Ω ,	-	0.1	0.5	ms
		ELM460A						
	Turn Off Time	ELM440A	T _{off}	I _F = 10 mA, I _L = MAX. R _L = 200Ω ,	-	0.2	0.5	ms
		ELM460A						
Isolation Resistance		R _{I-O}	V _{I-O} = 500V DC	5×10 ¹⁰	-	-	Ω	
Isolation Capacitance		C _{I-O}	V = 0V, f = 1MHz	-	1.5	-	pF	

Typical Electro-Optical Characteristics Curves

Figure 1. Load current vs Ambient temperature

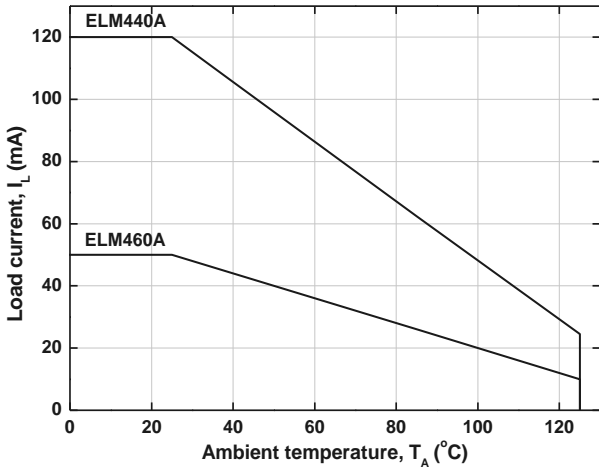

Figure 2. On Resistance vs Ambient Temperature

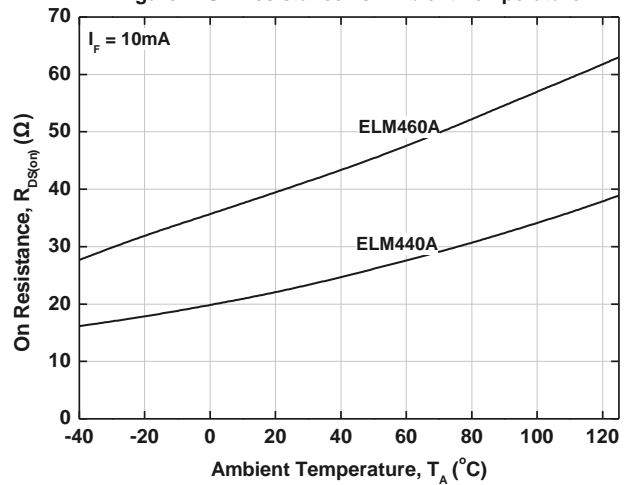

Figure 3. Switching Time vs Ambient Temperature

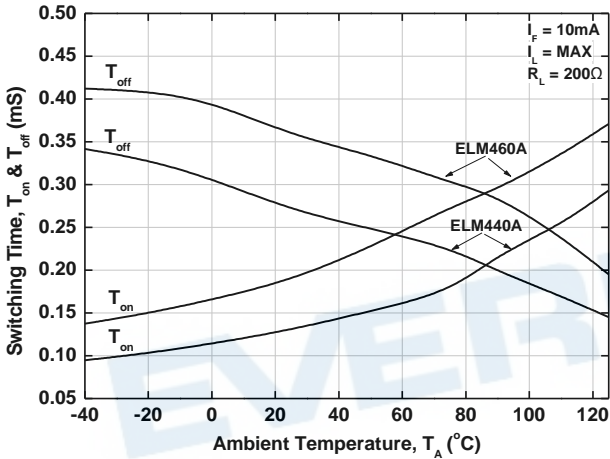

Figure 4. Switching time vs LED forward current

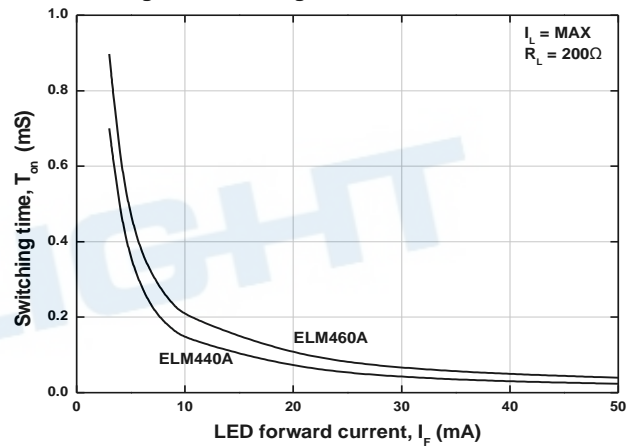

Figure 5. Switching time vs LED forward current

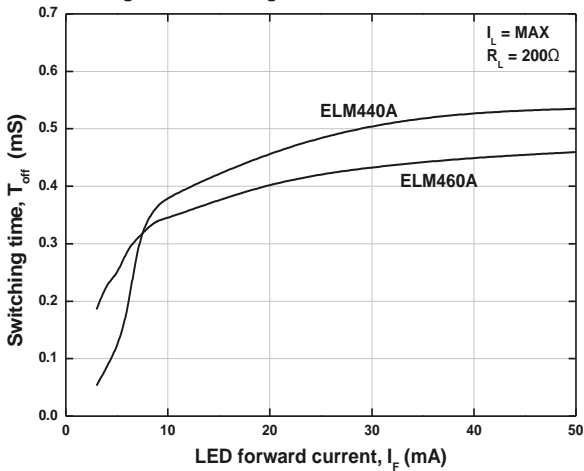

Figure 6. Normalized LED Operate on Current vs Ambient Temperature

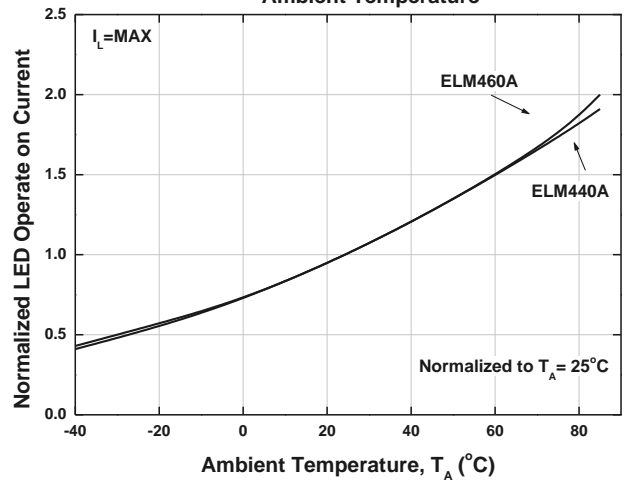

Figure 7. Normalized LED Operate off Current vs Ambient Temperature

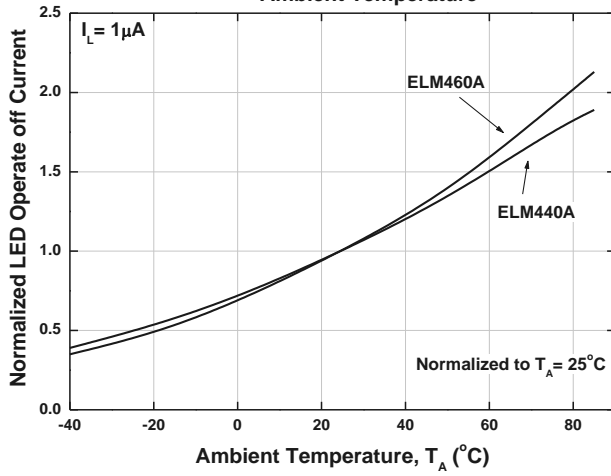

Figure 8. LED Dropout Voltage vs Ambient Temperature

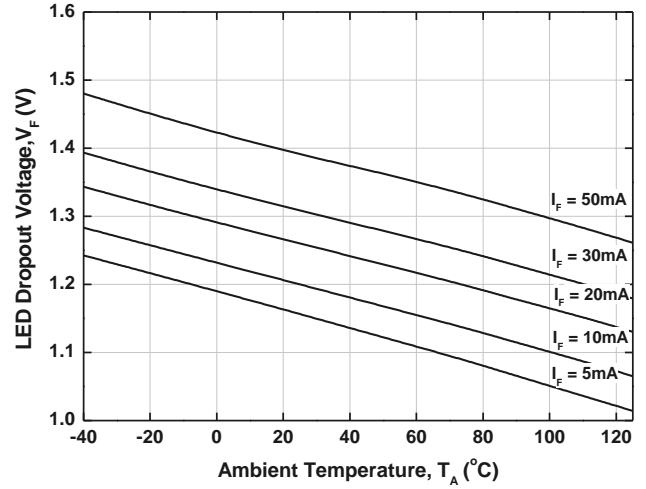

Figure 9. Load voltage vs Load current

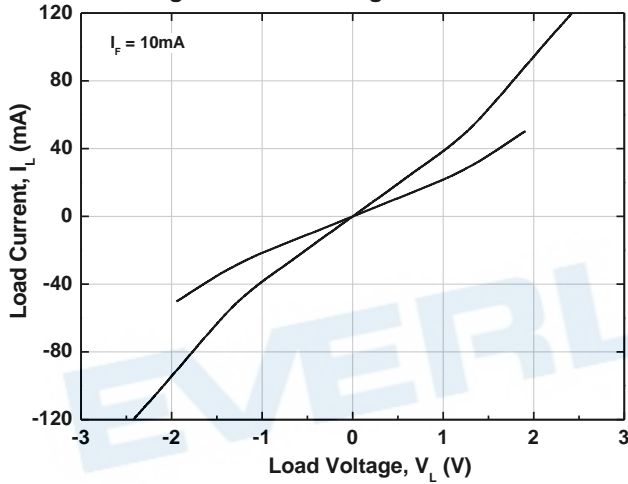

Figure 10. Off state leakage Current vs Load voltage

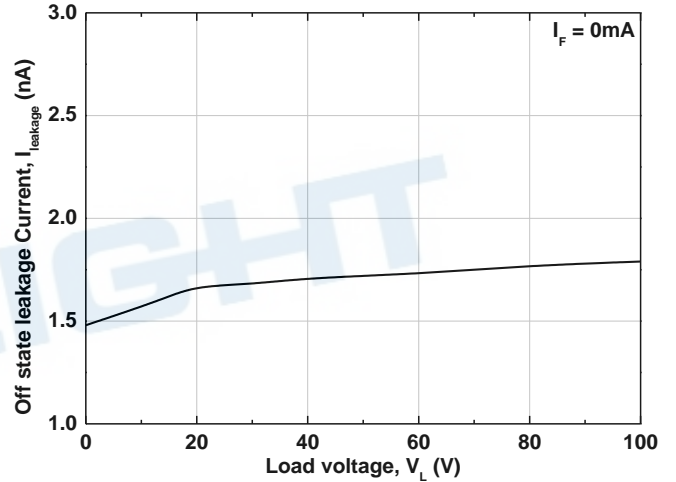
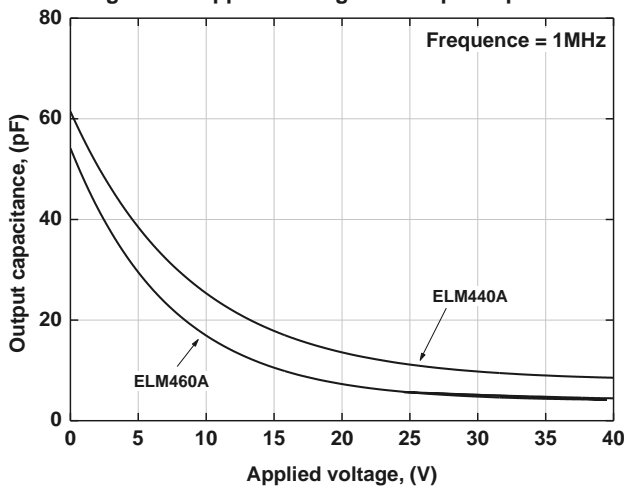
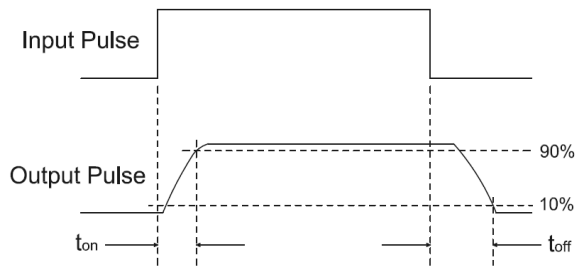

Figure 11. Applied voltage VS Output capacitance



Turn on/Turn off Time



EVERLIGHT

Order Information

Part Number

ELM4XXA(X)-VG

Note:

- 4XXA = Part No.(440A:400V 460A:600V)
- X = Tape and reel option (TA, TB or none).
- V = VDE (option)
- G = Halogen free

Option	Description	Packing quantity
None	Standard SMD option	100 units per tube
-V	Standard SMD option + VDE	100 units per tube
(TA)	TA Tape & reel option	3000 units per reel
(TB)	TB Tape & reel option	3000 units per reel
(TA)-V	TA Tape & reel option + VDE	3000 units per reel
(TB)-V	TB Tape & reel option + VDE	3000 units per reel

Package Dimension (Dimensions in mm)

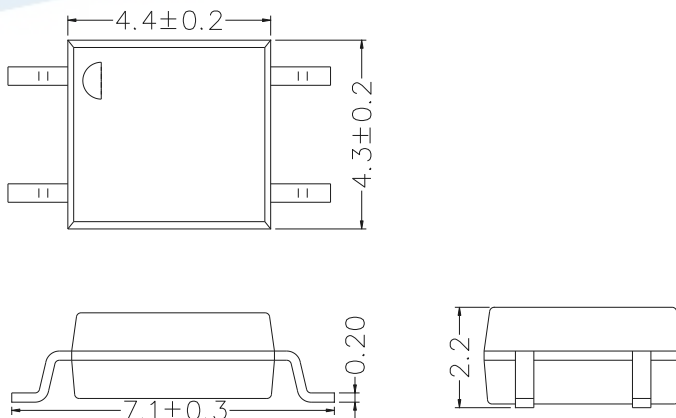

Recommended Pad Layout for Surface Mount Leadform

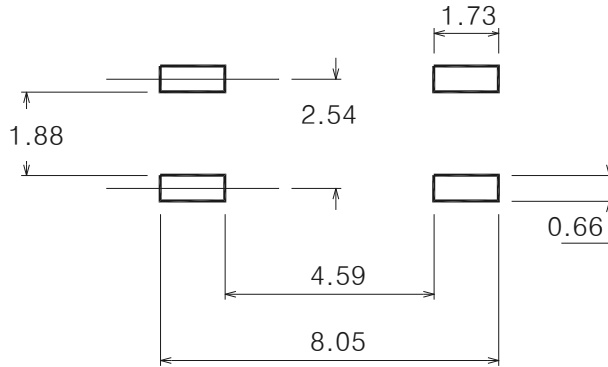

Device Marking



Notes

- EL denotes Everlight
- M440A denotes Part Number
- Y denotes 1 digit Year code
- WW denotes 2 digit Week code
- V denotes VDE approved (optional)

Tape & Reel Packing Specifications

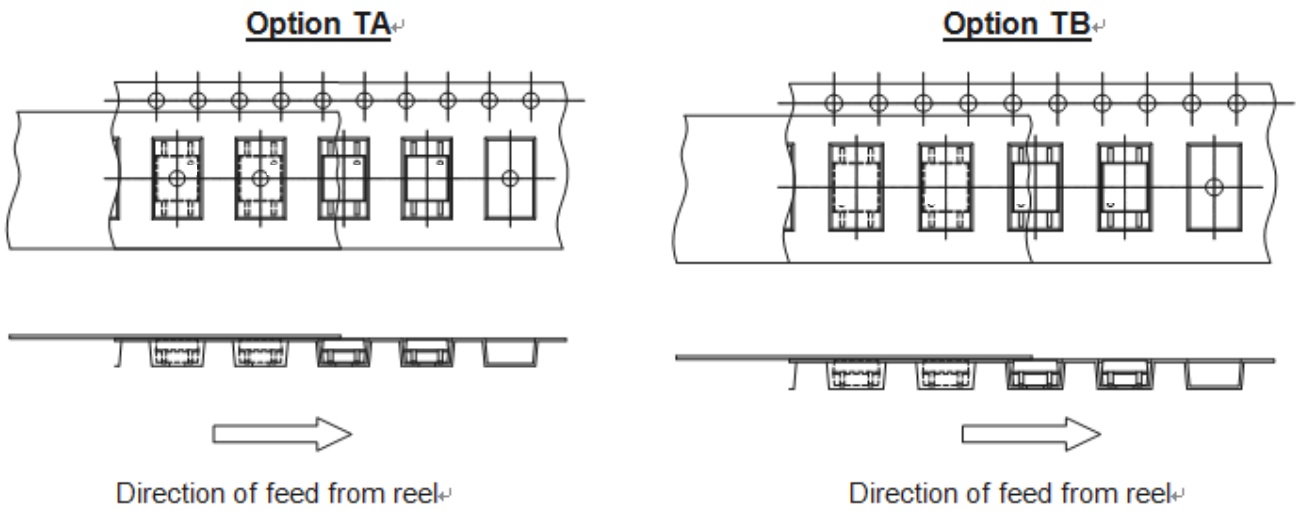

Tape dimensions

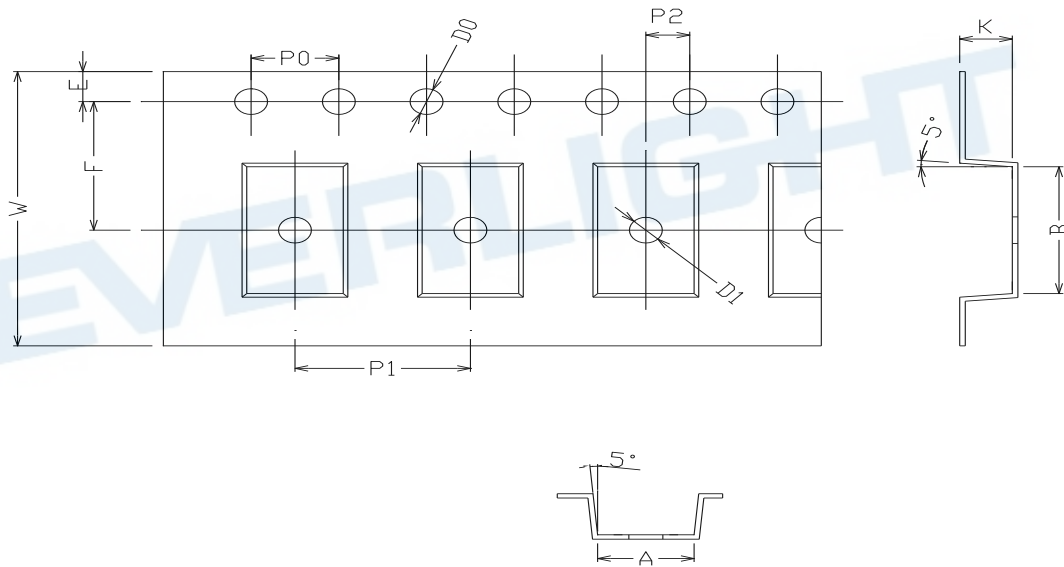

Dimension No.	A	B	Do	D1	E	F
Dimension (mm)	4.4 ± 0.1	7.4 ± 0.1	1.5 + 0.1/-0	1.5 ± 0.1	1.75 ± 0.1	7.5 ± 0.05
Dimension No.	Po	P1	P2	t	W	K
Dimension (mm)	4.0 ± 0.15	8.0 ± 0.1	2.0 ± 0.1	0.25 ± 0.03	16.0 ± 0.2	2.4 ± 0.1

Precautions for Use

1. Soldering Condition

1.1 (A) Maximum Body Case Temperature Profile for evaluation of Reflow Profile

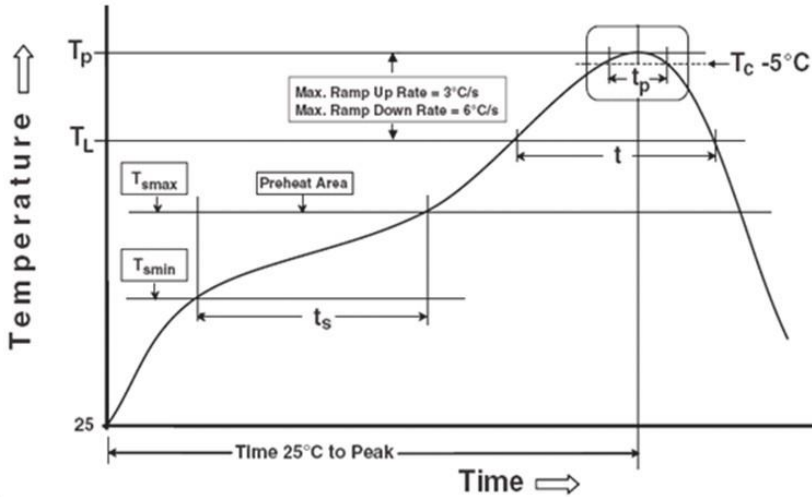

Note:

Reference: IPC/JEDEC J-STD-020D

Preheat

Temperature min (T_{smin})	150 °C
Temperature max (T_{smax})	200°C
Time (T_{smin} to T_{smax}) (t_s)	60-120 seconds
Average ramp-up rate (T_{smax} to T_p)	3 °C/second max

Other

Liquidus Temperature (T_L)	217 °C
Time above Liquidus Temperature (t_L)	60-100 sec
Peak Temperature (T_P)	260°C
Time within 5 °C of Actual Peak Temperature: $T_P - 5^\circ\text{C}$	30 s
Ramp- Down Rate from Peak Temperature	6°C /second max.
Time 25°C to peak temperature	8 minutes max.
Reflow times	3 times

DISCLAIMER

1. Above specification may be changed without notice. EVERLIGHT will reserve authority on material change for above specification.
2. The graphs shown in this datasheet are representing typical data only and do not show guaranteed values.
3. When using this product, please observe the absolute maximum ratings and the instructions for use outlined in these specification sheets. EVERLIGHT assumes no responsibility for any damage resulting from use of the product which does not comply with the absolute maximum ratings and the instructions included in these specification sheets.
4. These specification sheets include materials protected under copyright of EVERLIGHT. Reproduction in any form is prohibited without the specific consent of EVERLIGHT.
5. This product is not intended to be used for military, aircraft, automotive, medical, life sustaining or life saving applications or any other application which can result in human injury or death. Please contact authorized Everlight sales agent for special application request.
6. Statements regarding the suitability of products for certain types of applications are based on Everlight's knowledge of typical requirements that are often placed on Everlight products in generic applications. Such statements are not binding statements about the suitability of products for a particular application. It is the customer's responsibility to validate that a particular product with the properties described in the product specification is suitable for use in a particular application. Parameters provided in datasheets and/or specifications may vary in different applications and performance may vary over time. All operating parameters, including typical parameters, must be validated for each customer application by the customer's technical experts. Product specifications do not expand or otherwise modify Everlight's terms and conditions of purchase, including but not limited to the warranty expressed therein.

单击下面可查看定价，库存，交付和生命周期等信息

[>>Everlight\(亿光\)](#)