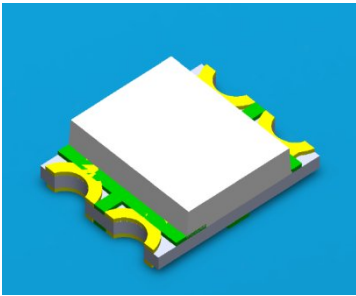

## SMD ■ B

## 19-226/BHG7C-C30/2T

**Features**

- Package in 8mm tape on 7" diameter reel.
- Compatible with automatic placement equipment.
- Compatible with infrared and vapor phase reflow solder process.
- Mono-color type.
- Pb-free.
- The product itself will remain within RoHS compliant version.
- Compliance with EU REACH.
- Compliance Halogen Free .(Br <900 ppm ,Cl <900 ppm , Br+Cl < 1500 ppm).

**Description**

- The 19-226 SMD LED is much smaller than lead frame type components, thus enable smaller board size, higher packing density, reduced storage space and finally smaller equipment to be obtained.

- Besides, lightweight makes them ideal for miniature applications. etc.

## **Applications**

- Telecommunication: indicator and backlighting in telephone and fax.
- Flat backlight for LCD, switch and symbol.
- General use.

EVERLIGHT

## Device Selection Guide

Chip Type	Chip Materials	Emitted Color	Resin Color
BH	InGaN	Blue	Water Clear
G7	AlGaInP	Brilliant Yellow Green	Water Clear

## Absolute Maximum Ratings (Ta=25 °C)

Parameter	Symbol	Rating	Unit
Reverse Voltage	$V_R$	5	V
Forward Current	$I_F$	BH : 10 G7 : 25	mA
Peak Forward Current (Duty 1/10 @1KHz)	$I_{FP}$	BH : 100 G7 : 60	mA
Power Dissipation	$P_d$	BH : 40 G7 : 60	mW
Operating Temperature	$T_{opr}$	-40 ~ +85	
Storage Temperature	$T_{stg}$	-40 ~ +90	
Electrostatic Discharge	$ESD_{HBM}$	BH : 150 G7 : 2000	V
Soldering Temperature	$T_{sol}$	Reflow Soldering : 260 Hand Soldering : 350	for 10 sec. for 3 sec.

Electro-Optical Characteristics (Ta=25 )

Parameter	Symbol	Min.	Typ.	Max.	Unit	Condition
Luminous Intensity	I <sub>v</sub>	BH : 18.0	-----	45.0	mcd	I <sub>F</sub> =5mA
		G7 : 11.5	-----	22.5		
Viewing Angle	2θ <sub>1/2</sub>	-----	120	-----	deg	
Peak Wavelength	p	BH : -----	468	-----	nm	
		G7 : -----	575	-----		
Dominant Wavelength	d	BH : 464.5	-----	476.5	nm	
		G7 : 567.5	-----	575.5		
Spectrum Radiation Bandwidth		BH : -----	25	-----	nm	
		G7 : -----	20	-----		
Forward Voltage	V <sub>F</sub>	BH : 2.5	-----	3.1	V	
		G7 : 1.6	-----	2.4		
Reverse Current	I <sub>R</sub>	BH : -----	-----	50	μA	V <sub>R</sub> =5V
		G7 : -----	-----	10		

Note:

1. Tolerance of Luminous Intensity: ±11%

**BH**

**Bin Range of Luminous Intensity**

Bin Code	Min.	Max.	Unit	Condition
M	18.0	28.5	mcd	$I_F = 5\text{mA}$
N	28.5	45.0		

**G7**

**Bin Range of Luminous Intensity**

Bin Code	Min.	Max.	Unit	Condition
----------	------	------	------	-----------

L1	11.5	14.5		
L2	14.5	18.5	mcd	I <sub>F</sub> =5mA
M1	18.0	22.5		

Note:

1.Tolerance of Luminous Intensity: ±11%

EVERLIGHT

Typical Electro-Optical Characteristics Curves  
BH

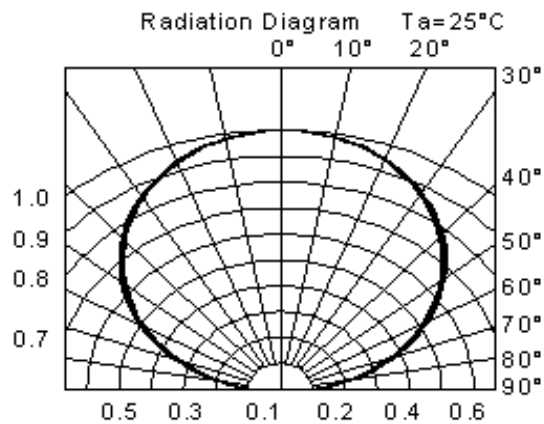
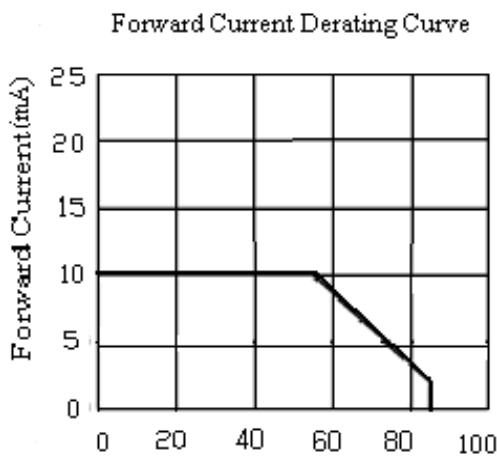
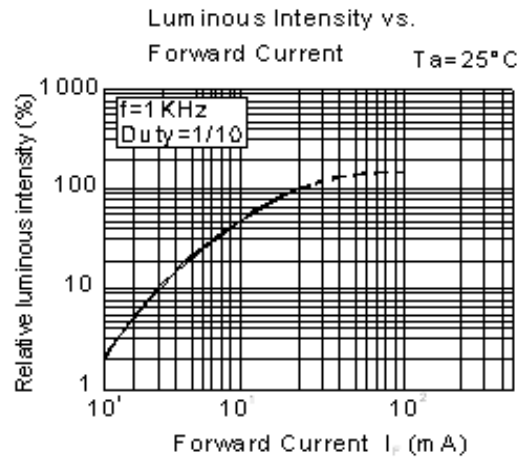
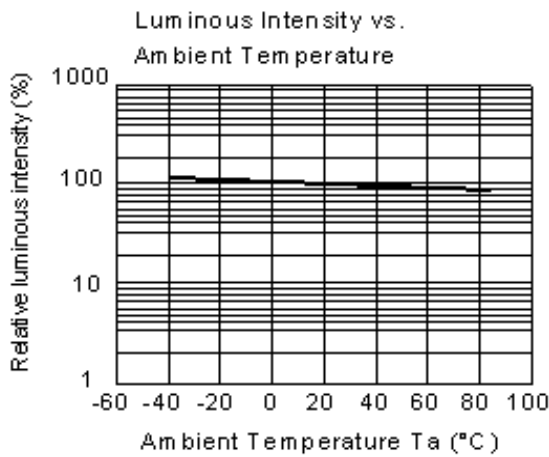
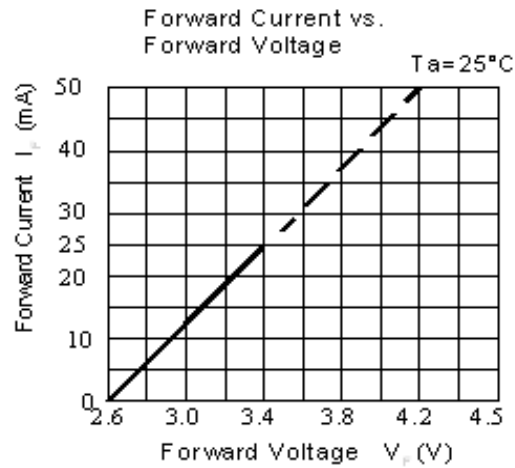
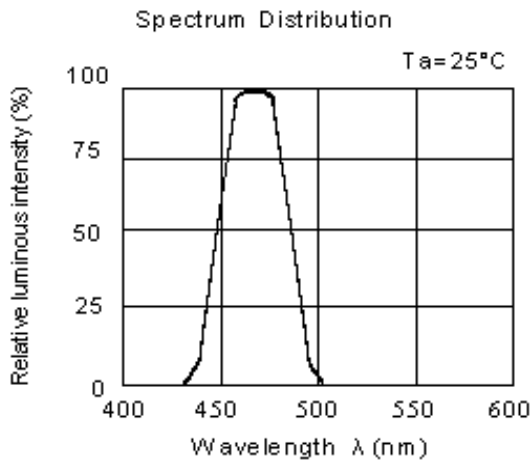

**Typical Electro-Optical Characteristics Curves  
G7**

EVERLIGHT



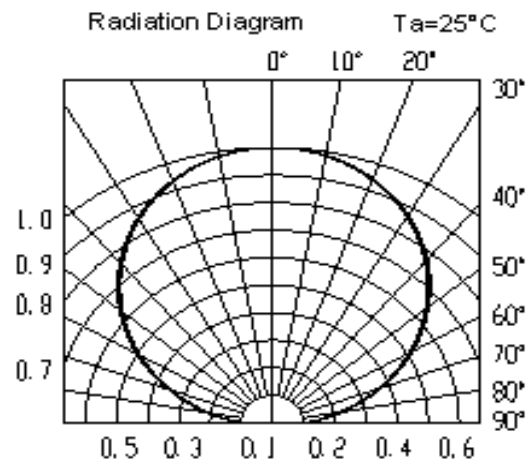
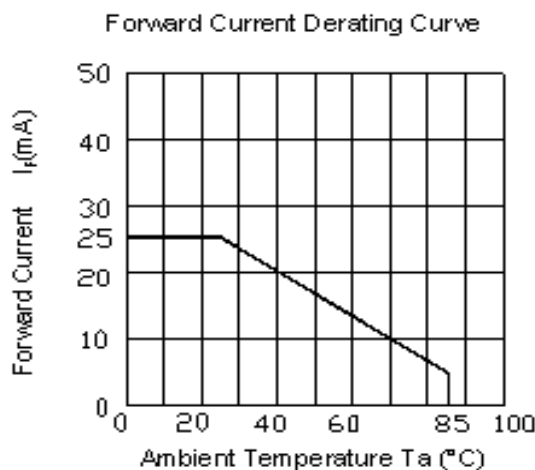
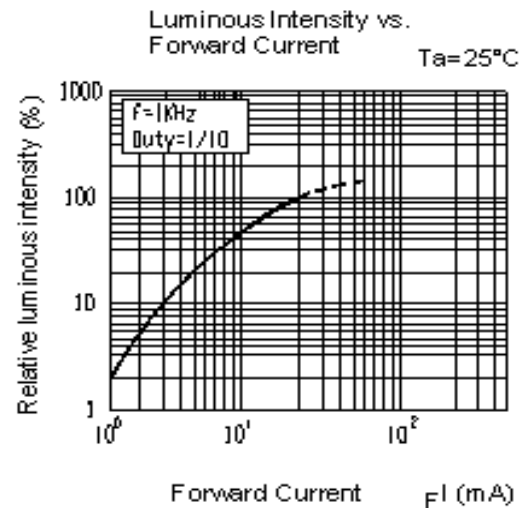
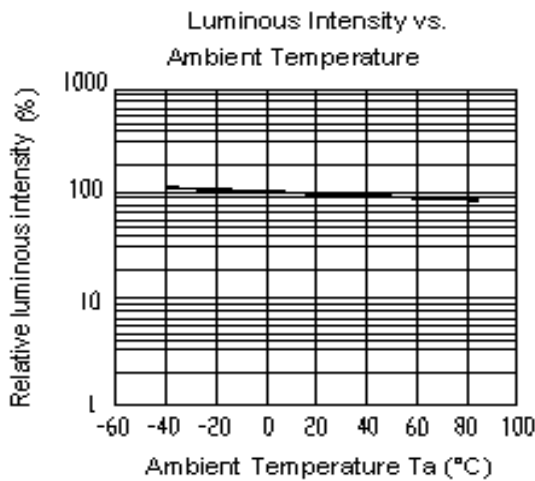
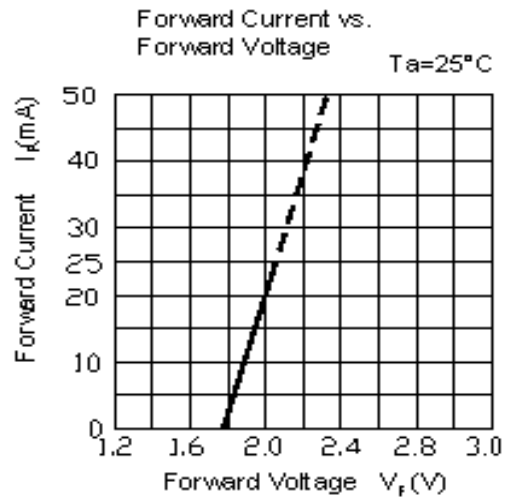
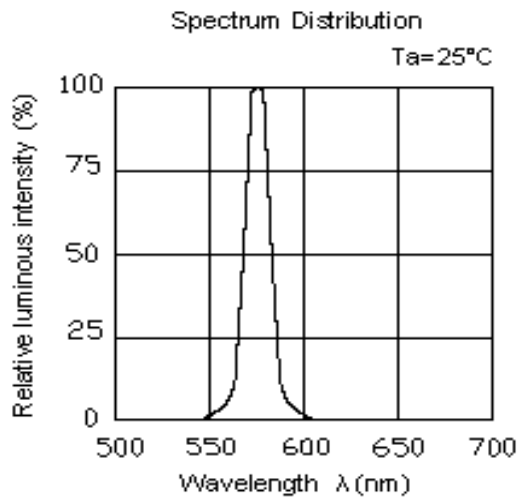

## Package Outline Dimensions

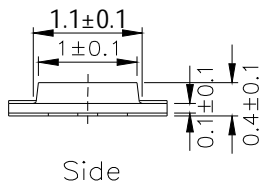
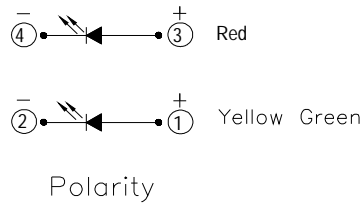
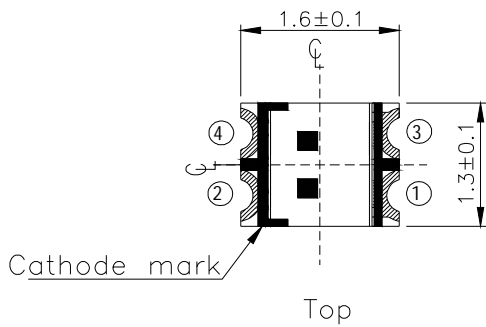

Recommend soldering pad

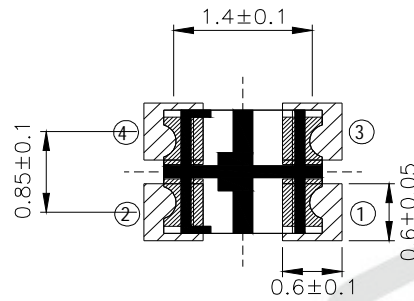
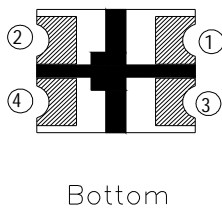

Suggested pad dimension is just for reference only.  
Please modify the pad dimension based on individual need.

Note: Tolerances unless mentioned  $\pm 0.1$ mm. Unit = mm  
Suggested pad dimension is just for reference only.  
Please modify the pad dimension based on individual need.

Label Explanation



- CPN: Customer's Product Number
- P/N: Product Number
- QTY: Packing Quantity
- CAT: Luminous Intensity Rank
- HUE: Chromaticity Coordinates & Dom. Wavelength Rank
- REF: Forward Voltage Rank
- LOT No: Lot Number

Reel Dimensions

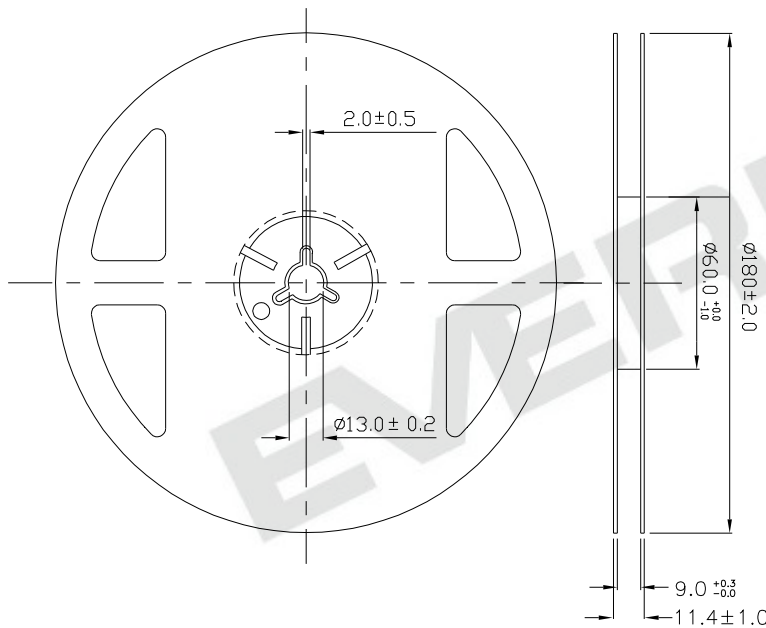

Note: The tolerances unless mentioned is  $\pm 0.1\text{mm}$ , Unit = mm

**Carrier Tape Dimensions: Loaded quantity 2000 PCS per reel**

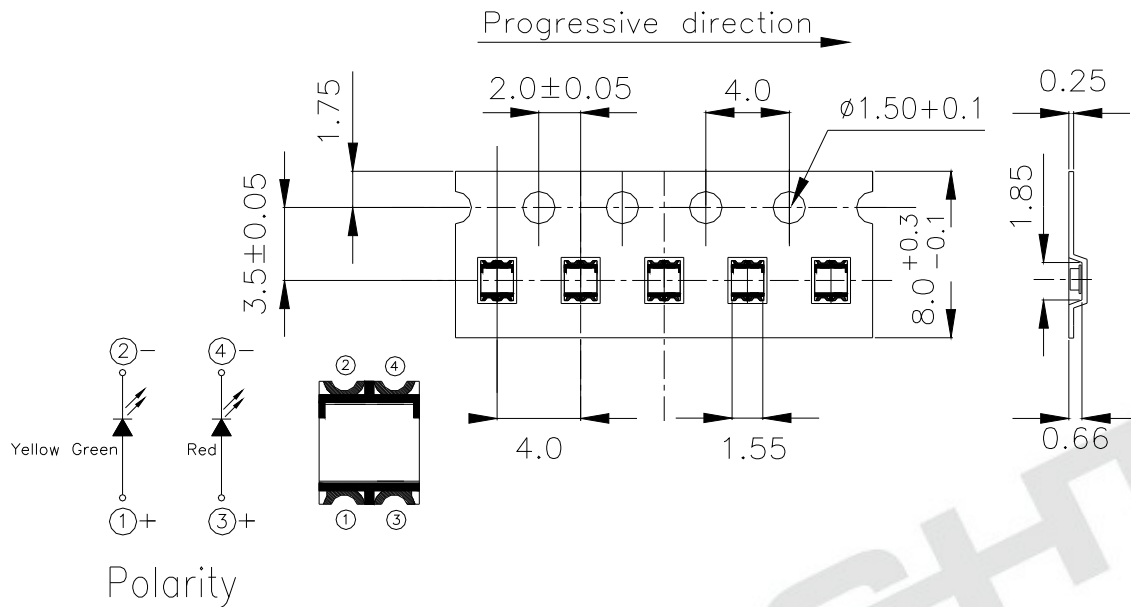

**Note:** The tolerances unless mentioned is  $\pm 0.1\text{mm}$ , Unit = mm

**Moisture Resistant Packaging**

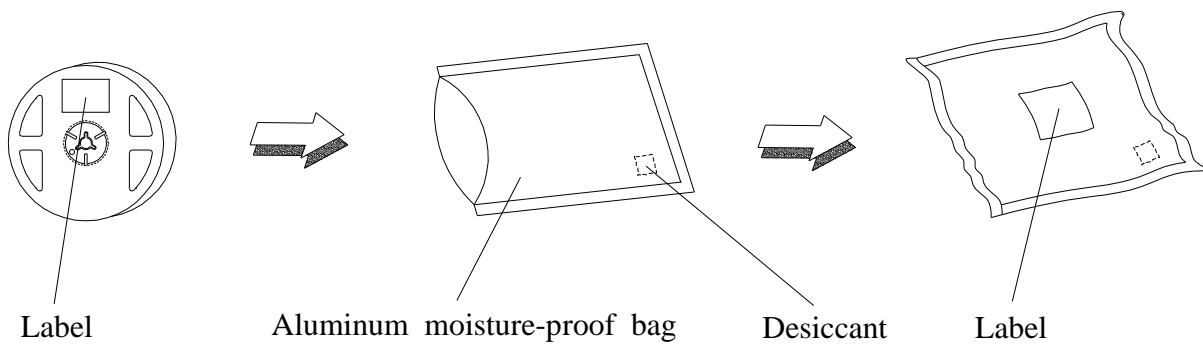

## Precautions For Use

### 1. Over-current-proof

Customer must apply resistors for protection, otherwise slight voltage shift will cause big current change ( Burn out will happen ).

### 2. Storage

2.1 Do not open moisture proof bag before the products are ready to use.

2.2 After opening the package: The LEDs should be kept at 30 or less and 60%RH or less.

2.3 The LEDs should be used within 168 hours (7days) after opening the package .

If unused LEDs remain, it should be stored in moisture proof packages.

2.4 If the moisture absorbent material (silica gel) has faded away or the LEDs have exceeded the storage time, baking treatment should be performed using the following conditions.

Baking treatment :  $60\pm 5$  for 24 hours.

### 3. Soldering Condition

#### 3.1 Pb-free solder temperature profile

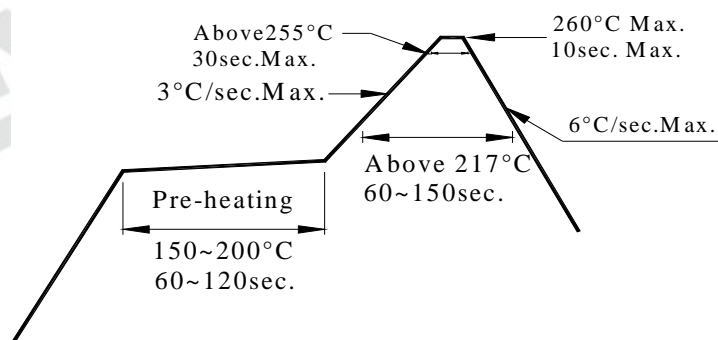

3.2 Reflow soldering should not be done more than two times.

3.3 When soldering, do not put stress on the LEDs during heating.

3.4 After soldering, do not warp the circuit board.

### 4. Soldering Iron

Each terminal is to go to the tip of soldering iron temperature less than 350 for 3 seconds within once in less than the soldering iron capacity 25W. Leave two seconds and more intervals, and do soldering of each terminal. Be careful because

the damage of the product is often started at the time of the hand solder.

#### 5.Repairing

Repair should not be done after the LEDs have been soldered. When repairing is unavoidable, a double-head soldering iron should be used (as below figure). It should be confirmed beforehand whether the characteristics of the LEDs will or will not be damaged by repairing.

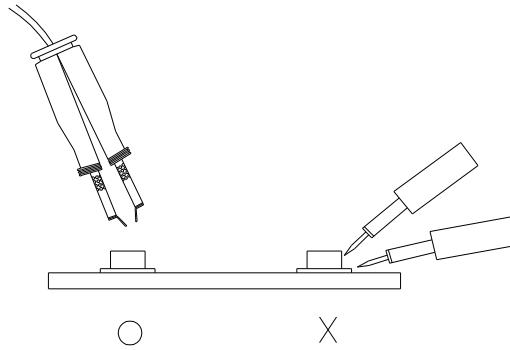

## Application Restrictions

High reliability applications such as military/aerospace, automotive safety/security systems, and medical equipment may require different product. If you have any concerns, please contact Everlight before using this product in your application. This specification guarantees the quality and performance of the product as an individual component. Do not use this product beyond the specification described in this document.

EVERLIGHT

单击下面可查看定价，库存，交付和生命周期等信息

[>>Everlight \(亿光\)](#)