



Technical Data Sheet

Opto Interrupter

ITR9606-F

■ Features

- Fast response time
- High analytic
- Cut-off visible wavelength $\lambda_p=940\text{nm}$
- High sensitivity
- Pb free
- This product itself will remain within RoHS compliant version



■ Descriptions

- The ITR9606-F consist of an infrared emitting diode and an NPN silicon phototransistor, encased side-by-side on converging optical axis in a black thermoplastic housing,
- The phototransistor receives radiation from the IRED only .This is the normal situation.
- But when an object is in between , phototransistor could not receives the radiation.
- For additional component information , please refer to IR928-6C-F and PT928-6C-F

■ Applications

- Mouse Copier
- Switch Scanner
- Floppy disk driver
- Non-contact Switching
- For Direct Board

■ Device Selection Guide

| Device No. | Chip Material | LENS COLOR |
|------------|---------------|-------------|
| IR928-6C-F | GaAlAs | Water clear |
| PT928-6C-F | Silicon | Water clear |

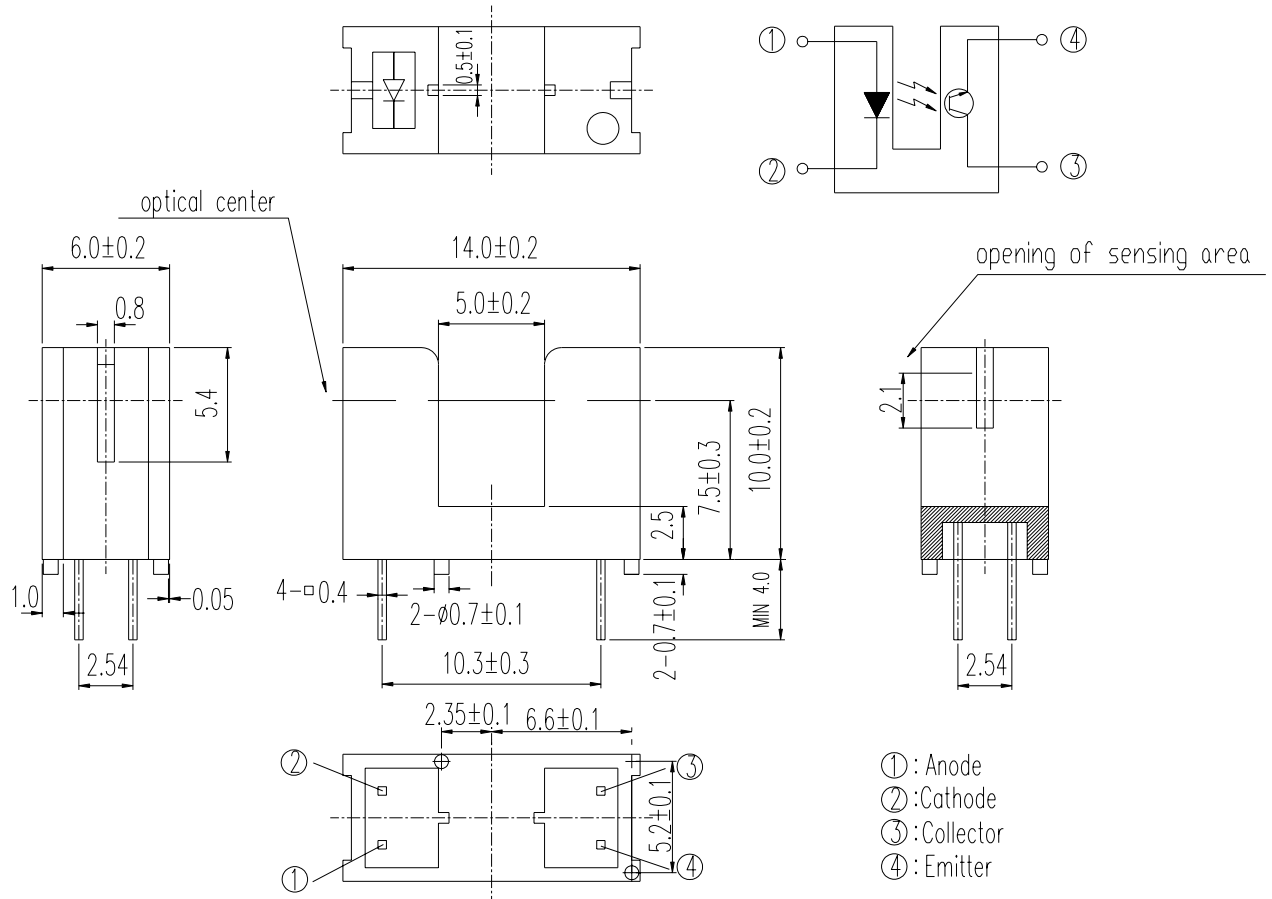
Package Dimensions

Notes:

1. All dimensions are in millimeters
2. Tolerances unless dimensions ± 0.2 mm
3. Lead spacing is measured where the lead emerge from the package
4. Above specification may be changed without notice. EVERLIGHT will reserve authority on material change for above specification
5. These specification sheets include materials protected under copyright of EVERLIGHT corporation. Please don't reproduce or cause anyone to reproduce them without EVERLIGHT's consent
6. When using this product, please observe the absolute maximum ratings and the instructions for use outlined in these specification sheets. EVERIGHT assumes no responsibility for any damage resulting from use of the product which does not comply with the absolute maximum ratings and the instructions included in these specification sheets.

Absolute Maximum Ratings (Ta=25°C)

| Parameter | | Symbol | Ratings | Unit |
|--|--|--------------------|---------|------|
| Input | Power Dissipation at(or below) 25°C Free Air Temperature | Pd | 75 | mW |
| | Reverse Voltage | V _R | 5 | V |
| | Forward Current | I _F | 50 | mA |
| | Peak Forward Current (*1) Pulse width ≤ 100 μs, Duty cycle=1% | I _{FP} | 1 | A |
| | Collector Power Dissipation | Pd | 75 | mW |
| Output | Collector Current | I _C | 20 | mA |
| | Collector-Emitter Voltage | B V _{CEO} | 30 | V |
| | Emitter-Collector Voltage | B V _{ECO} | 5 | V |
| | Operating Temperature | Topr | -25~+85 | °C |
| Storage Temperature | | Tstg | -40~+85 | °C |
| Lead Soldering Temperature (*2) (1/16 inch form body for 5 seconds) | | Tsol | 260 | °C |

(*1) $t_w=100 \mu sec.$, $T=10 msec.$ (*2) $t=5 Sec$

Electro-Optical Characteristics (Ta=25°C)

| Parameter | | Symbol | Min. | Typ. | Max. | Unit | Conditions |
|--------------------------|------------------------|----------------------|------|------|------|------|--|
| Input | Forward Voltage | V _F | --- | 1.2 | 1.5 | V | I _F =20mA |
| | Reverse Current | I _R | --- | --- | 10 | μA | V _R =5V |
| | Peak Wavelength | λ _P | --- | 940 | --- | nm | I _F =20mA |
| | View Angle | 2θ1/2 | --- | 60 | --- | Deg | I _F =20mA |
| Output | Dark C urrent | I _{CEO} | --- | --- | 100 | nA | V _{CE} =20V, Ee=0mW/cm ² |
| | C-E Saturation Voltage | V _{CE(sat)} | --- | --- | 0.4 | V | I _C =2mA, Ee=1mW/cm ² |
| Transfer Characteristics | Collect Current | I _{C(ON)} | 0.5 | --- | 10 | mA | V _{CE} =5V |
| | | I _{c(OFF)} | --- | --- | 20 | μA | I _F =20mA |
| | Rise time | t _r | --- | 15 | --- | μsec | V _{CE} =5V |
| | Fall time | t _f | --- | 15 | --- | μsec | I _C =1mA R _L =1KΩ |

Typical Electrical/Optical/Characteristics Curves for IR

Fig.1 Forward Current vs.

Ambient Temperature

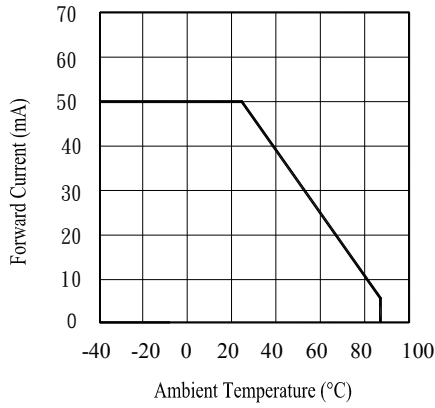

Fig.2 Spectral Distribution

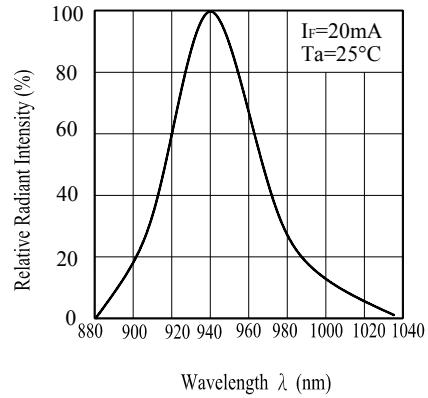

Fig.3 Peak Emission Wavelength vs. Ambient Temperature

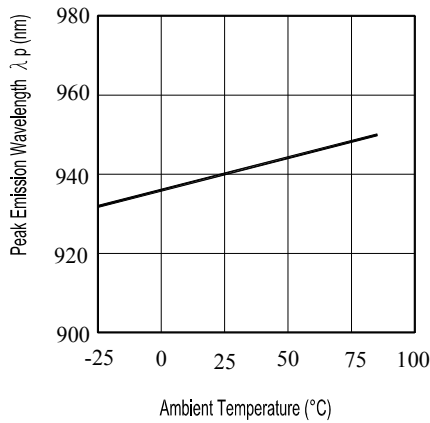

Fig.4 Forward Current vs. Forward Voltage

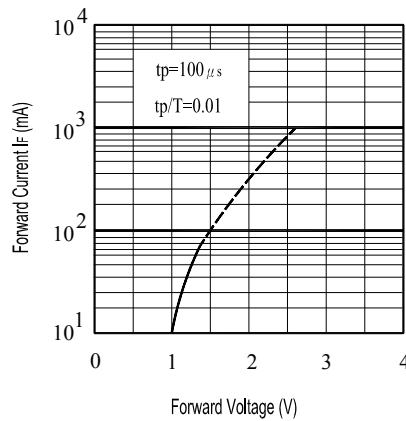

Fig.5 Forward Current vs. Ambient Temperature(°C)

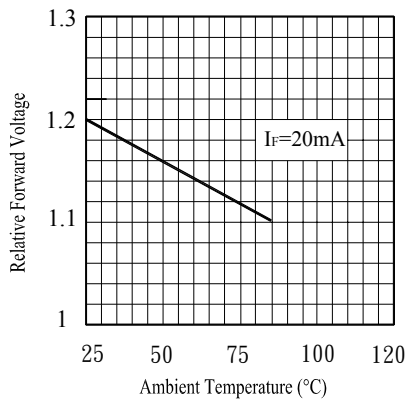
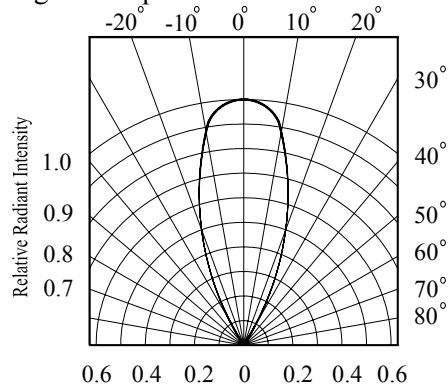

Fig.6 Relative Radiant Intensity vs. Angular Displacement



Typical Electrical/Optical/Characteristics Curves for PT

Fig.1 Collector Power Dissipation vs. Ambient Temperature

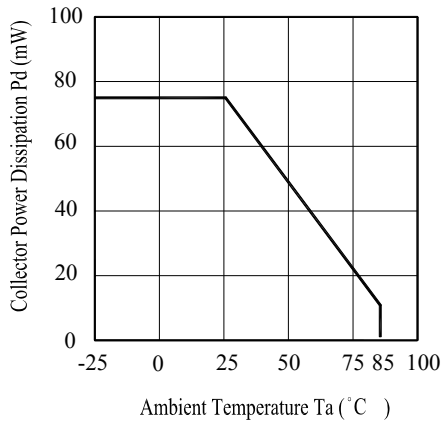

Fig.2 Spectral Sensitivity

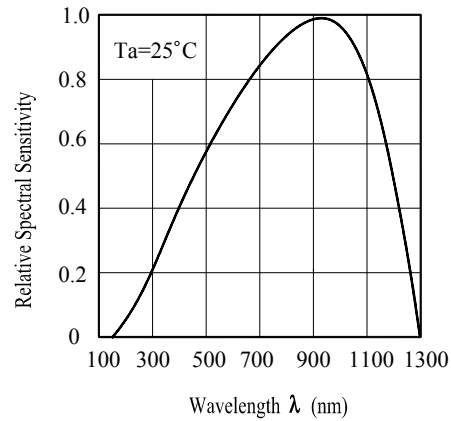

Fig.3 Relative Collector Current vs. Ambient Temperature

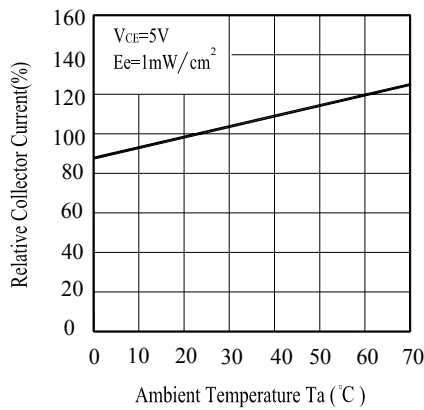

Fig.4 Collector Current vs. Irradiance

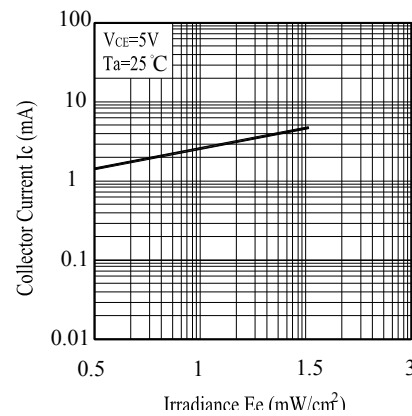

Fig.5 Collector Dark Current vs. Ambient Temperature

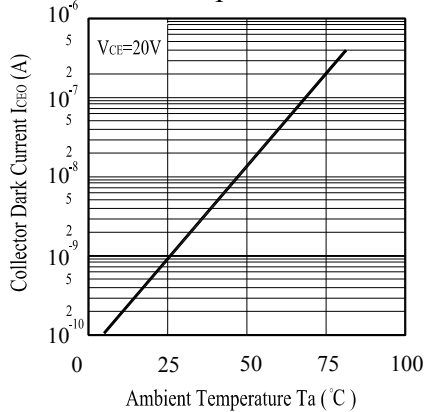
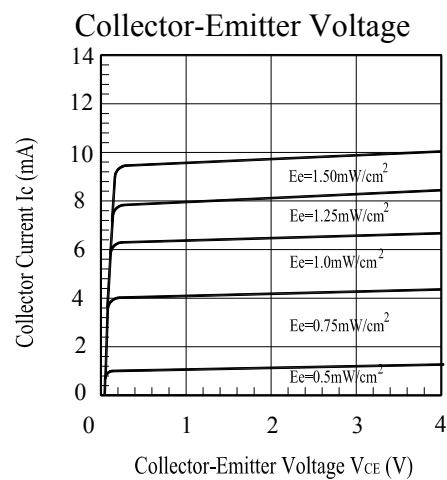

Fig.6 Collector Current vs. Collector-Emitter Voltage



Reliability Test Item And Condition

The reliability of products shall be satisfied with items listed below.

Confidence level : 90%





LTPD : 10%

| NO. | Item | Test Condition | Test Hours/ Cycle | Sample Size | Failure Judgement Criteria | Ac/Re |
|-----|----------------------------------|--|----------------------|-------------|---|-------|
| 1 | Solder Heat | TEMP : 260°C ± 5 °C | 10 sec | 22 PCs | More than 90% of lead to be covered by soldering $I_R \geq U \times 2$ $E_e \leq L \times 0.8$ $V_F \geq U \times 1.2$ U :Upper specification limit L :Lower specification limit | 0/1 |
| 2 | Temperature Cycle | H : +100°C 15 min \updownarrow 5 min \updownarrow L : -40°C 15 min | 300 cycle | 22 PCs | | 0/1 |
| 3 | Thermal Shock | H : +100°C 5 min \updownarrow 10 sec \updownarrow L : -10°C 5 min | 300 cycle | 22 PCs | | 0/1 |
| 4 | High Temperature Storage | TEMP. : +100°C | 1000 hrs | 22 PCs | | 0/1 |
| 5 | Low Temperature Storage | TEMP. : -40°C | 1000 hrs | 22 PCs | | 0/1 |
| 6 | DC Operating Life | $V_{CE}=5V$ $I_F=20mA$ | 1000 hrs | 22 PCs | | 0/1 |
| 7 | High Temperature / High Humidity | 85°C / 85% R.H. | 1000 hrs | 22 PCs | | 0/1 |

Packing Quantity Specification

1. 35pcs/Tube, 100 Tubes/Box, 4 boxes/Chect

Label Form Specification

| | | |
|---|---|-----------------------------------|
|  | | CPN: Customer's Production Number |
| CPN: | | P/N : Production Number |
| P/N: | | QTY: Packing Quantity |
| |  | CAT: Ranks |
| | ITR9606-F | HUE: Peak Wavelength |
| QTY: | | REF: Reference |
| |  | LOT No: Lot Number |
| CAT: | | |
| HUE: | | |
| REF: | | |
| LOT NO: | | |
| |  | |

Notes

1. Above specification may be changed without notice. EVERLIGHT will reserve authority on material change for above specification.
2. When using this product, please observe the absolute maximum ratings and the instructions for using outlined in these specification sheets. EVERLIGHT assumes no responsibility for any damage resulting from use of the product which does not comply with the absolute maximum ratings and the instructions included in these specification sheets.

These specification sheets include materials protected under copyright of EVERLIGHT corporation. Please don't reproduce or cause anyone to reproduce them without EVERLIGHT's consent.

| | |
|---|--|
| EVERLIGHT ELECTRONICS CO., LTD. Office: No 25, Lane 76, Sec 3, Chung Yang Rd, Tucheng, Taipei 236, Taiwan, R.O.C | Tel: 886-2-2267-2000, 2267-9936 Fax: 886-2267-6244, 2267-6189, 2267-6306 http://www.everlight.com |
|---|--|

单击下面可查看定价，库存，交付和生命周期等信息

[>>Everlight \(亿光\)](#)