

4 PIN SOP HIGH VOLTAGE PHOTODARLINGTON PHOTOCOUPLER EL452-G Series

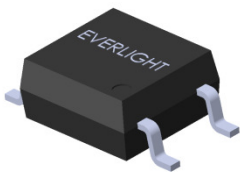

Schematic

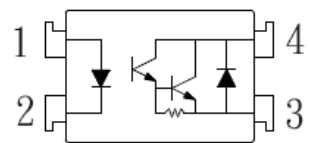

Pin Configuration

1. Anode
2. Cathode
3. Emitter
4. Collector

Features:

- Halogens free
- High collect-Emitter voltage ($V_{CEO} = 350V$)
- Current transfer ratio
(CTR: Min. 1000% at $I_F = 1mA, V_{CE} = 2V$)
- High isolation voltage between input and output
($V_{iso} = 3750 V rms$)
- Compact 4 Pin SOP with a 2.0 mm profile
- Pb free and RoHS compliant.
- UL & CUL approved
- VDE approved
- SEMKO approved
- NEMKO approved
- DEMKO approved
- FIMKO approved

Description

The EL452-G contains an infrared emitting diode, optically coupled to a high voltage darlington phototransistor.

It is packaged in a 4-pin small outline SMD package.

Applications

- Telephone set, telephone exchangers
- Sequence controllers
- System appliances, measuring instruments
- Signal transmission between circuits of different potentials and impedance

Absolute Maximum Ratings (Ta=25°C)

	Parameter	Symbol	Rating	Unit
Input	Forward current	I_F	60	mA
	Peak forward current (t = 10μs)	I_{FM}	1	A
	Power dissipation	P_D	100	mW
Output	Power dissipation	P_C	150	mW
	Collector current	I_C	150	mA
	Collector-Emitter voltage	V_{CEO}	350	V
	Emitter-Collector voltage	V_{ECO}	0.1	V
	Total power dissipation	P_{TOT}	170	mW
	Isolation voltage ^{*1}	V_{ISO}	3750	V rms
	Operating temperature	T_{OPR}	-55~+110	°C
	Storage temperature	T_{STG}	-55~+125	°C
	Soldering Temperature ^{*2}	T_{SOL}	260	°C

Notes:

*1 AC for 1 minute, R.H.= 40 ~ 60% R.H. In this test, pins 1 & 2 are shorted together, and pins 3 & 4 are shorted together.

*2 For 10 seconds

Electro-Optical Characteristics (Ta=25°C unless specified otherwise)

Input

Parameter	Symbol	Min.	Typ.*	Max.	Unit	Condition
Forward Voltage	V_F	-	1.2	1.4	V	$I_F = 10\text{mA}$
Reverse Current	I_R	-	-	10	μA	$V_R = 4\text{V}$
Input capacitance	C_{in}	-	50	-	pF	$V = 0, f = 1\text{KHz}$

Output

Parameter	Symbol	Min.	Typ.*	Max.	Unit	Condition
Collector-Emitter dark current	I_{CEO}	-	-	100	nA	$V_{CE} = 200\text{V}, I_F = 0\text{mA}$
Collector-Emitter breakdown voltage	BV_{CEO}	350	-	-	V	$I_C = 0.1\text{mA}$
Emitter-Collector breakdown voltage	BV_{ECO}	0.1	-	-	V	$I_E = 0.01\text{mA}$

Transfer Characteristics

Parameter	Symbol	Min.	Typ.*	Max.	Unit	Condition
Current Transfer ratio	CTR	1000	2000	-	%	$I_F = 1\text{mA}, V_{CE} = 2\text{V}$
Collector-emitter saturation voltage	$V_{CE(sat)}$	-	1.2	1.5	V	$I_F = 20\text{mA}, I_C = 100\text{mA}$
Isolation resistance	R_{IO}	5×10^{10}	10^{11}	-	Ω	$V_{IO} = 500\text{Vdc}, 40 \sim 60\% R.H$
Cut-off frequency	f_c	-	7	-	KHz	$V_{CE} = 2\text{V}, I_C = 2\text{mA}, R_L = 100\Omega, -3\text{db}$
Floating capacitance	C_{IO}	-	0.6	-	pF	$V_{IO} = 0, f = 1\text{MHz}$
Rise time	t_r	-	80	250	μs	$V_{CE} = 2\text{V}, I_C = 20\text{mA}, R_L = 100\Omega$
Fall time	t_f	-	10	100	μs	

* Typical values at $T_a = 25^\circ\text{C}$

Typical Electro-Optical Characteristics Curves

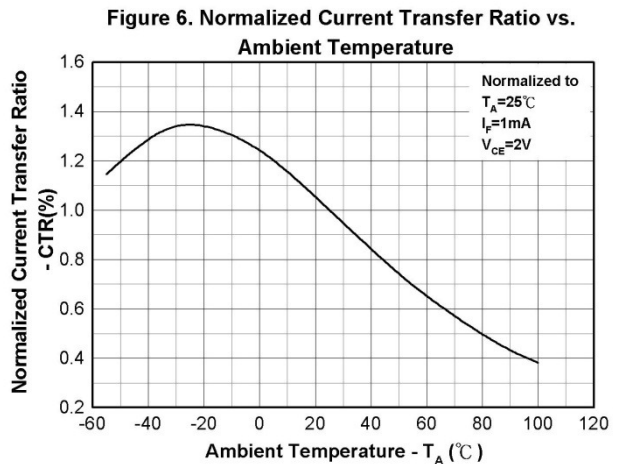
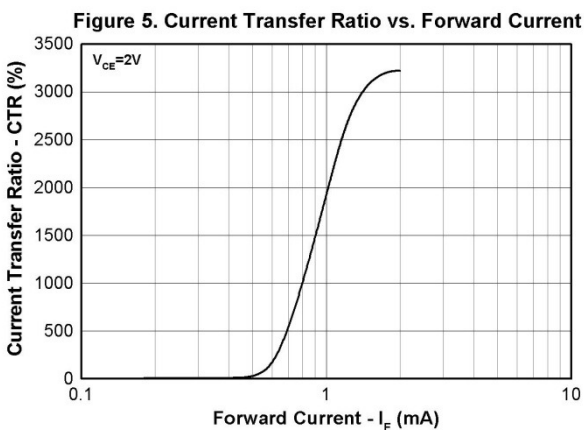
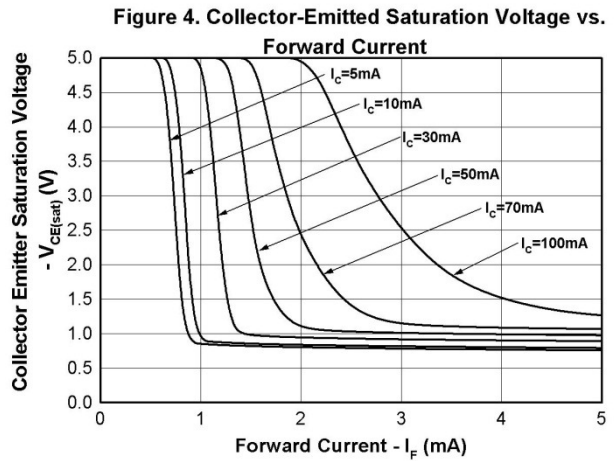
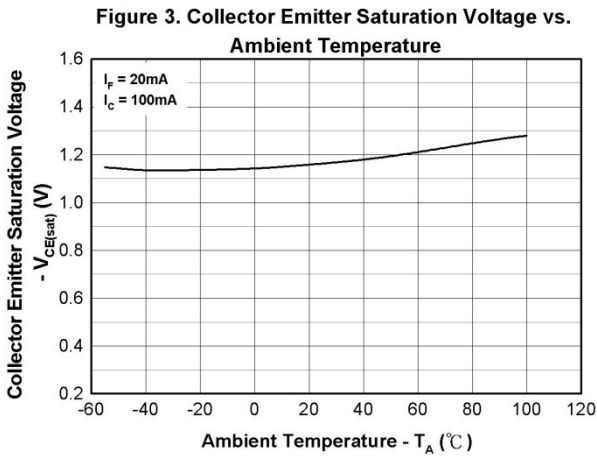
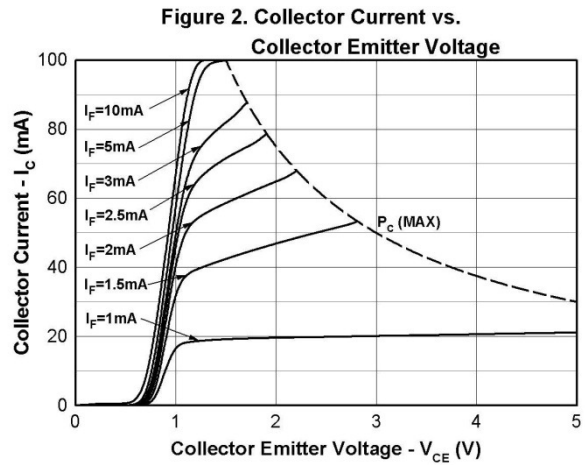
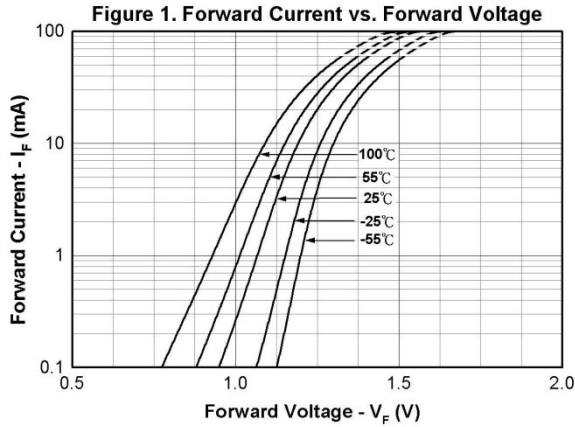

Figure 7. Collector Dark Current vs. Ambient Temperature

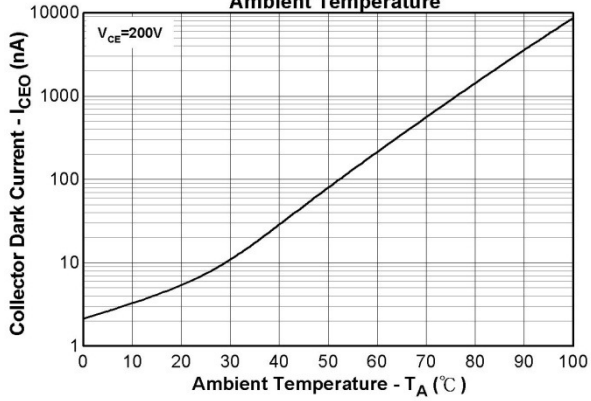

Figure 8. Response Time vs. Load Resistance

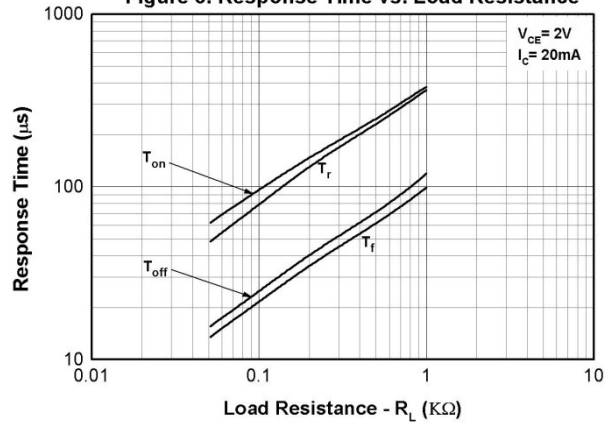
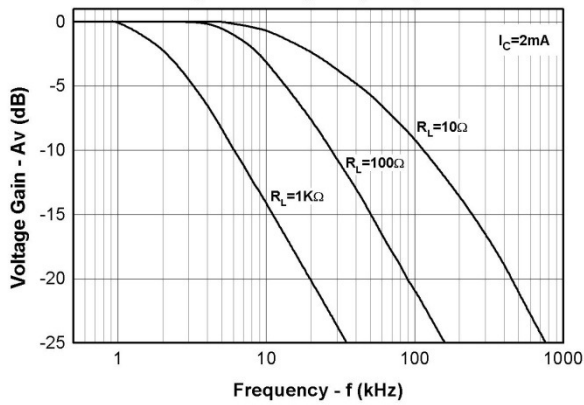

Figure 9. Frequency Response



Order Information

Part Number

EL452(Y)-VG

Note

Y = Tape and reel option (TA, TB, or none).

V = VDE safety (optional)

G = Halogens free

Option	Description	Packing quantity
None	Standard SMD option	100 units per tube
-V	Standard SMD option + VDE	100 units per tube
(TA)	TA Tape & reel option	3000 units per reel
(TB)	TB Tape & reel option	3000 units per reel
(TA)-V	TA Tape & reel option + VDE	3000 units per reel
(TB)-V	TB Tape & reel option + VDE	3000 units per reel

Package Dimension (Dimensions in mm)

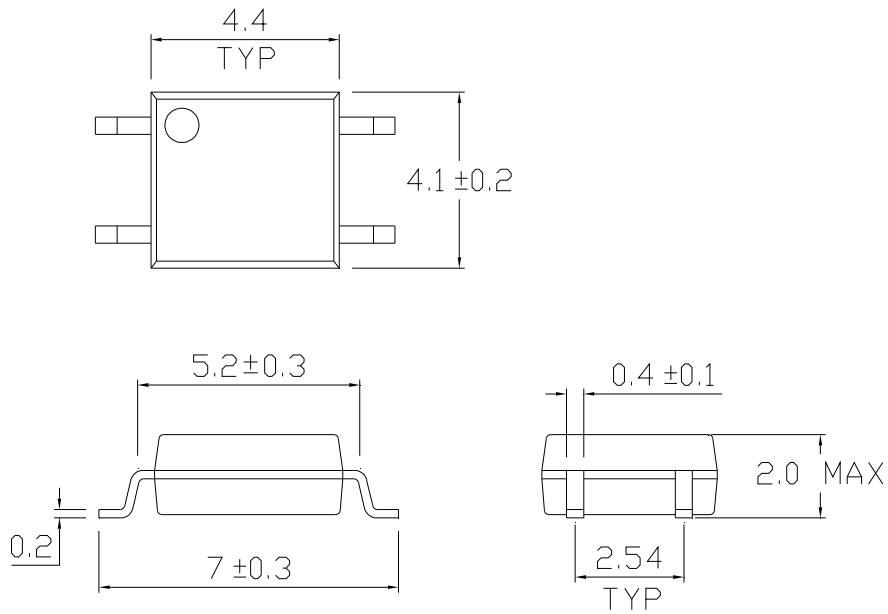

Recommended pad layout for surface mount leadform

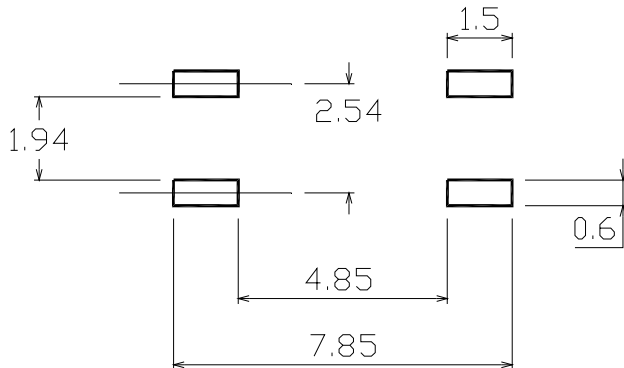

Device Marking



Notes

EL	denotes Everlight
452	denotes Part Number
Y	denotes 1 digit Year code
WW	denotes 2 digit Week code
V	denotes VDE approved (optional)

Tape & Reel Packing Specifications

Option TA

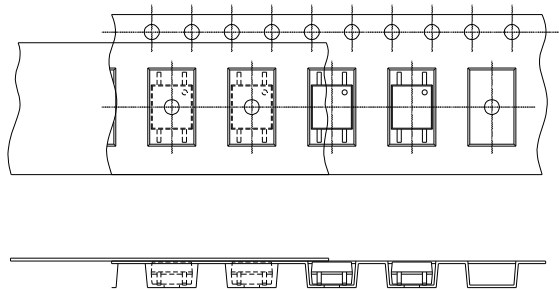

Direction of feed from reel

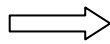

Option TB

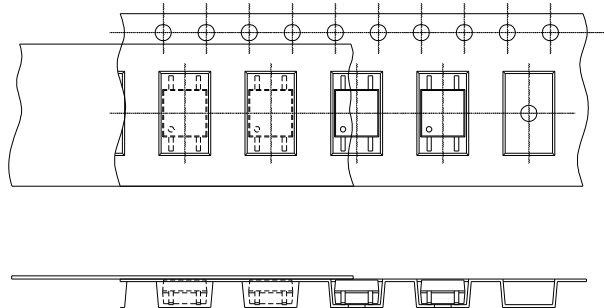

Direction of feed from reel

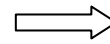

Tape dimensions

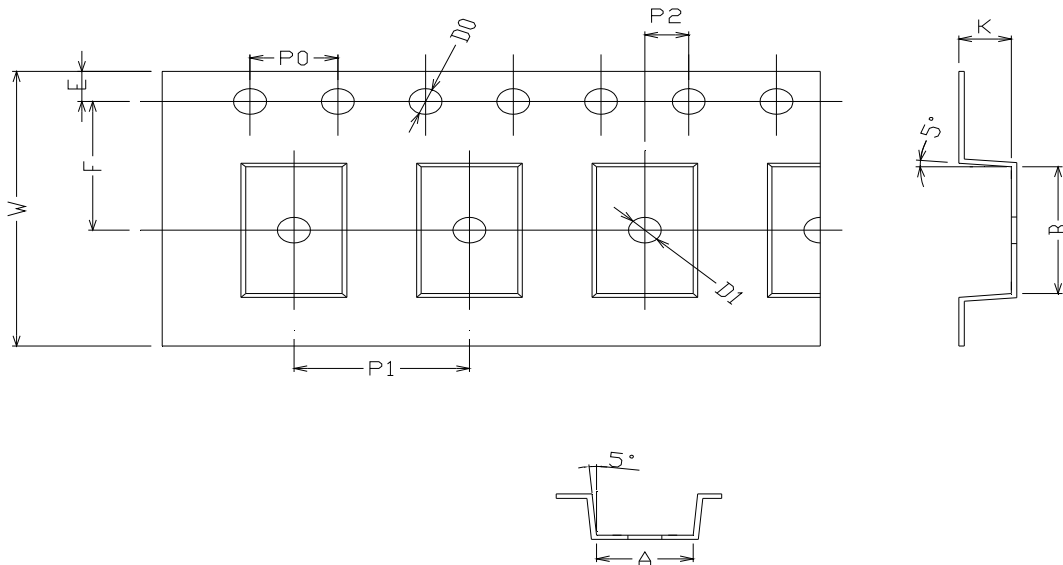

Dimension No.	A	B	Do	D1	E	F
Dimension(mm)	4.4 ± 0.1	7.4 ± 0.1	1.5 + 0.1/-0	1.5 ± 0.1	1.75 ± 0.1	7.5 ± 0.1
Dimension No.	Po	P1	P2	t	W	K
Dimension(mm)	4.0 ± 0.15	8.0 ± 0.1	2.0 ± 0.1	0.25 ± 0.03	16.0 ± 0.2	2.4 ± 0.1

Precautions for Use

1. Soldering Condition

1.1 (A) Maximum Body Case Temperature Profile for evaluation of Reflow Profile

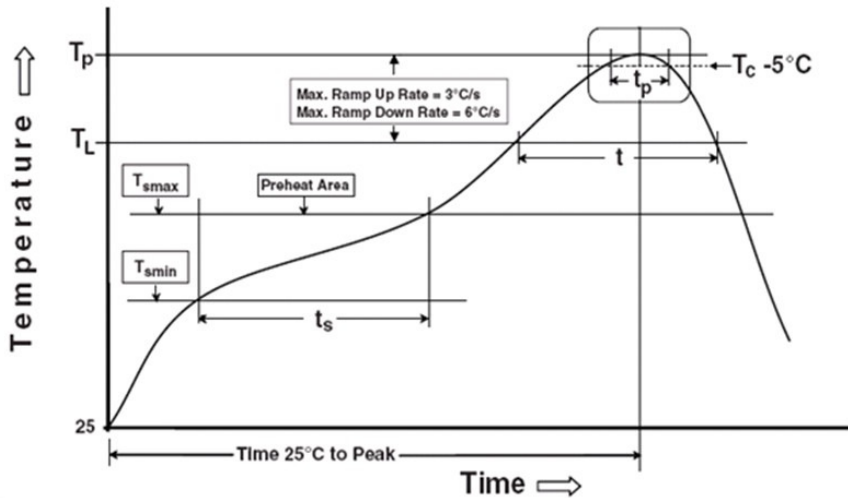

Note:

Reference: IPC/JEDEC J-STD-020D

Preheat

Temperature min (T_{smin})	150 °C
Temperature max (T_{smax})	200 °C
Time (T_{smin} to T_{smax}) (t_s)	60-120 seconds
Average ramp-up rate (T_{smax} to T_p)	3 °C/second max

Other

Liquidus Temperature (T_L)	217 °C
Time above Liquidus Temperature (t_L)	60-100 sec
Peak Temperature (T_p)	260 °C
Time within 5 °C of Actual Peak Temperature: $T_p - 5^\circ\text{C}$	30 s
Ramp- Down Rate from Peak Temperature	6 °C /second max.
Time 25°C to peak temperature	8 minutes max.
Reflow times	3 times

DISCLAIMER

1. Above specification may be changed without notice. EVERLIGHT will reserve authority on material change for above specification.
2. When using this product, please observe the absolute maximum ratings and the instructions for using outlined in these specification sheets. EVERLIGHT assumes no responsibility for any damage resulting from use of the product which does not comply with the absolute maximum ratings and the instructions included in these specification sheets.
3. These specification sheets include materials protected under copyright of EVERLIGHT corporation. Please don't reproduce or cause anyone to reproduce them without EVERLIGHT's consent.

单击下面可查看定价，库存，交付和生命周期等信息

[>>Everlight \(亿光\)](#)