

GENERAL PURPOSE SOLID STATE RELAY 4PIN DIP TYPE FORM A SSR

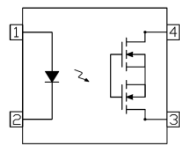

LED Anode 1
LED Cathode 2
MOSFET 3.4

Features

- Normally open signal pole signal throw relay
- Low operating current
- 60 to 600V output withstand voltage
- Low on resistance
- Wide operating temperature range of -40°C to 85°C
- High isolation voltage between input and output (Viso = 5000 Vrms)
- UL 1577 approved (No. E214129)
- UL 508 approved (No. E348721)
- VDE approved (No. 40028391)
- SEMKO approved
- NEMKO approved
- DEMKO approved
- FIMKO approved
- CQC approved

Description

The EL406A, EL425A, EL440A and EL460A are solid state relays containing an AlGaAs infrared LEDs on the light emitting side (input side) optically coupled to a high voltage output detector circuit. The detector consists of a photovoltaic diode array and MOSFETs on the output side.

The single channel configuration is equivalent to 1 form A EMR. They are packaged in 4 pin DIP and available in surface mount SMD option.

Applications

- Exchange equipment
- Measurement equipment
- FA/OA equipment
- Industrial controls
- Security

Absolute Maximum Ratings (T_A=25 °C, unless otherwise specified)

Parameter	Symbol	Rating				Unit	
		EL406A	EL425A	EL440A	EL460A		
Input	Forward Current	I _F		50		mA	
	Reverse Voltage	V _R		5		V	
	Peak Forward Current* ¹	I _{FP}		1		A	
	Power Dissipation	P _{in}		75		mW	
Output	Break Down Voltage	V _L	60	250	400	600	V
	Continuous Load Current	I _L	550	180	120	50	mA
	Pulse Load Current* ²	I _{LPeak}	1.2	0.5	0.3	0.15	A
	Power Dissipation	P _{out}		500			mW
	Total Power Dissipation	P _T		550			mW
Isolation Voltage* ³	V _{iso}			5000		V _{rms}	
Storage Temperature	T _{STG}			-40 to 125		°C	
Operating Temperature	T _{OPR}			-40 to 85		°C	
Soldering Temperature* ⁴	T _{SOL}			260		°C	

Notes:

*1. f =100Hz, Duty Cycle = 0.1%

*2. A connection: 100ms (1 shot), V_L = DC

*3. AC for 1 minute, R.H. = 40 ~ 60% R.H. In this test, pins 1, 2 are shorted together, and pins 3, 4 are shorted together.

*4. For 10 seconds

Electro-Optical Characteristics (T_A=25 °C)

	Parameter	Symbol	Condition	Min.	Typ.	Max.	Unit	
Input	Forward Voltage	V _F	I _F = 10mA	-	1.18	1.5	V	
	Reverse Current	I _R	V _R = 5V	-	-	1	μA	
Output	Off State leakage Current	I _{leak}	I _F = 0mA, V _L = Max.	-	-	1	μA	
	On Resistance	EL406A	R _{d(ON)}	I _F = 10mA, I _L = Max. t = 1s	-	0.7	2.5	Ω
		EL425A			-	6.5	15	
		EL440A			-	20	30	
		EL460A			-	40	70	
Output Capacitance	EL406A	C _{out}	V _L = 0V, f = 1MHz	-	85	-	pF	
	EL425A			-	60	-		
	EL440A			-	45	-		
	EL460A			-	30	-		
Transfer Characteristics	LED turn on Current	I _{F(on)}	I _L = Max.	-	2.5	5	mA	
	LED turn off current	I _{F(off)}	I _L = Max.	0.4	2.5	-	mA	
	Turn On Time	EL406A	T _{on}	I _F = 10 mA, I _L = Max. R _L = 200Ω ,	-	1.4	3	ms
		EL425A			-	1.2	3	
		EL440A			-	0.4	3	
		EL460A			-	1.4	3	
	Turn Off Time	EL406A	T _{off}	I _F = 10 mA, I _L = Max. R _L = 200Ω ,	-	0.05	0.5	ms
		EL425A			-	0.05	0.5	
		EL440A			-	0.05	0.5	
		EL460A			-	0.05	0.5	
Isolation Resistance	R _{I-O}	V _{I-O} = 500V DC	5×10 ¹⁰	-	-	Ω		
Isolation Capacitance	C _{I-O}	V = 0V, f = 1MHz	-	1.5	-	pF		

Turn on/Turn off Time

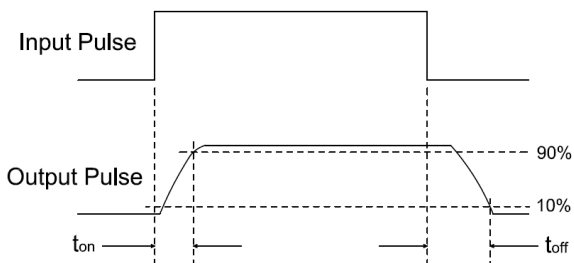

Typical Electro-Optical Characteristics Curves

Figure 1-1. Load current vs Ambient temperature

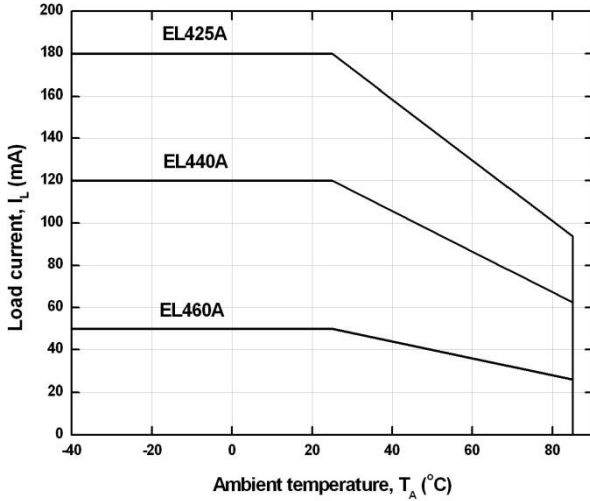

Figure 1-2. Load current vs Ambient temperature

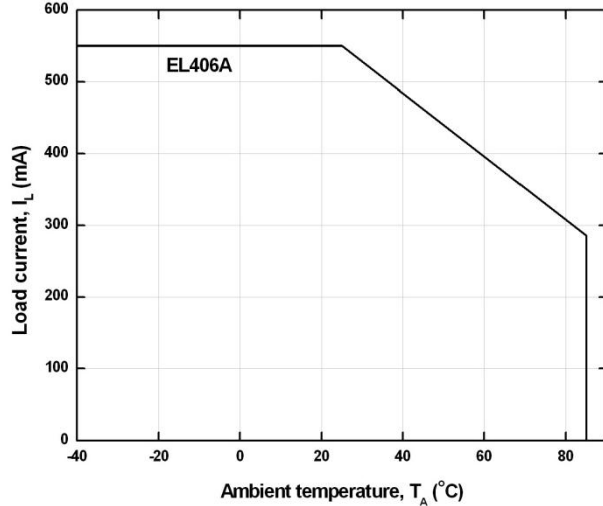

Figure 2-1. On Resistance vs Ambient Temperature

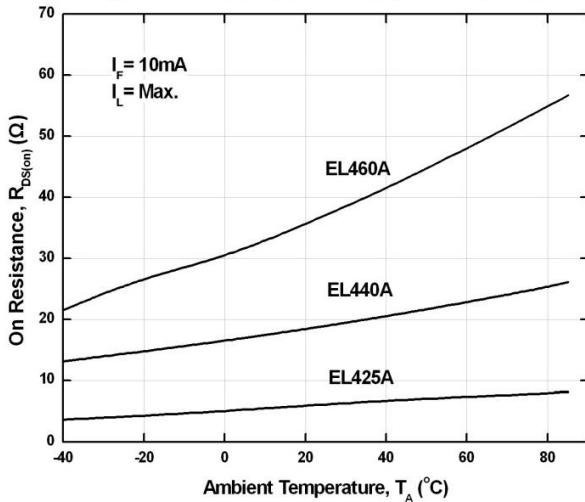

Figure 2-2. On Resistance vs Ambient Temperature

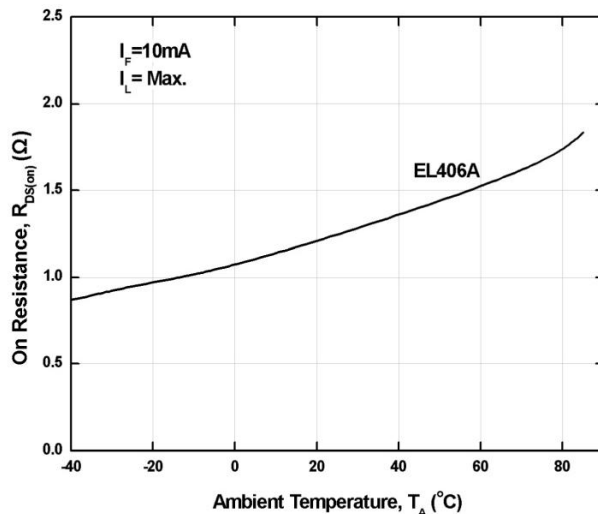

Figure 3. Switching Time vs Ambient Temperature

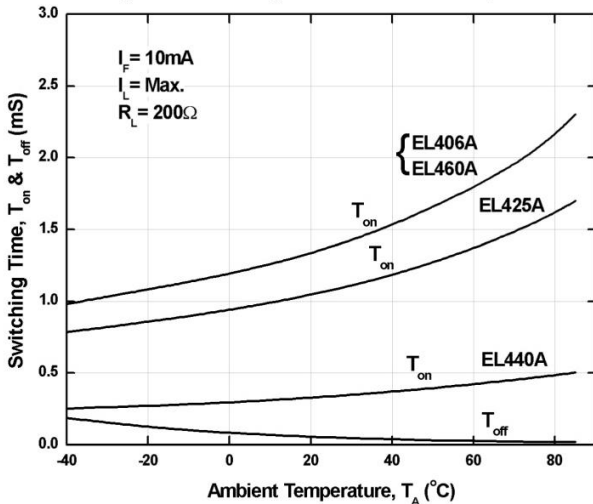

Figure 4-1. Turn On Time vs LED Forward Current

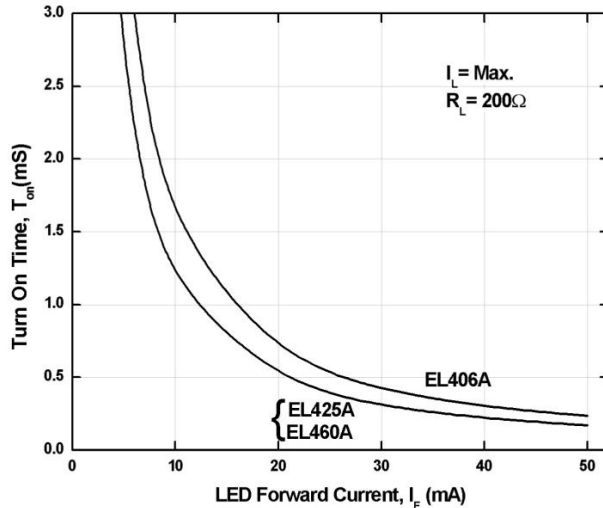

Figure 4-2. Turn On Time vs LED Forward Current

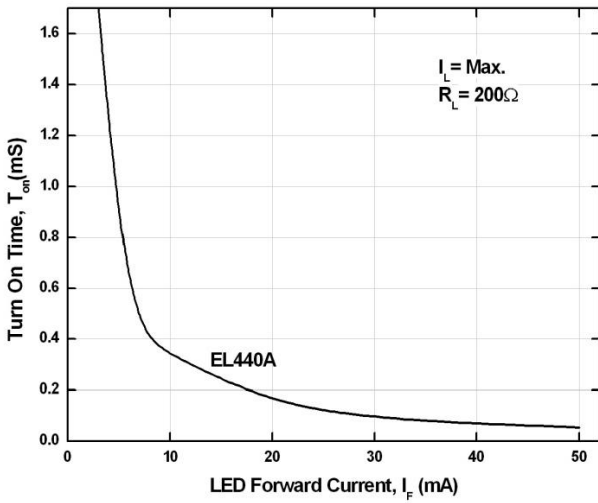

Figure 5. Turn Off Time vs LED Forward Current

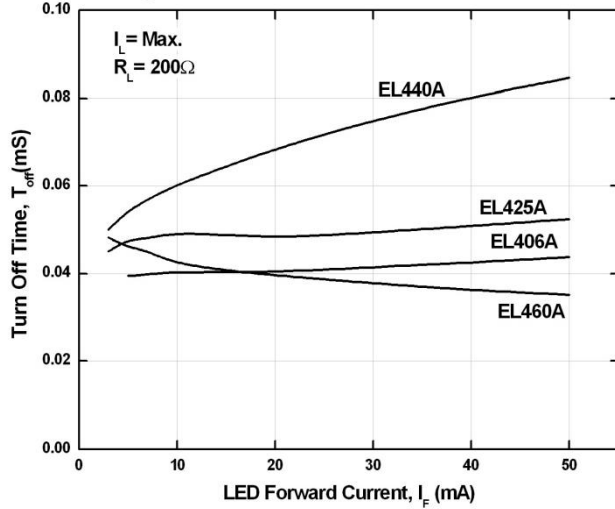

Figure 6. LED Operate on Current vs Ambient Temperature

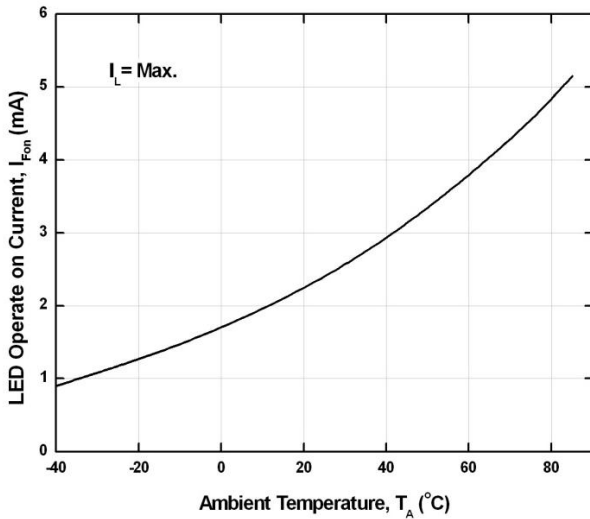

Figure 7. LED Turn off Current vs Ambient Temperature

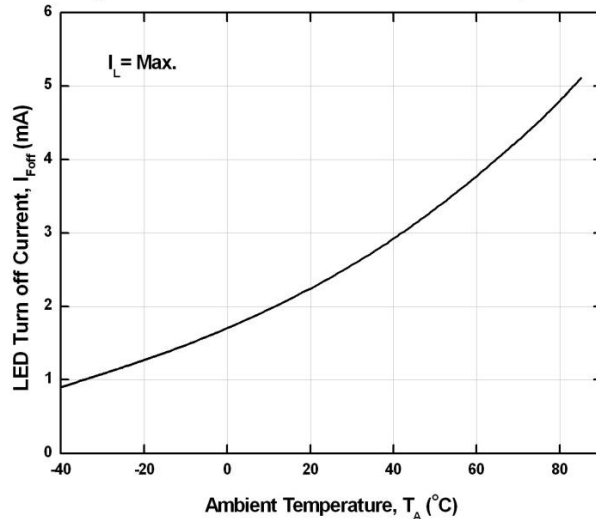

Figure 8. LED Dropout Voltage vs Ambient Temperature

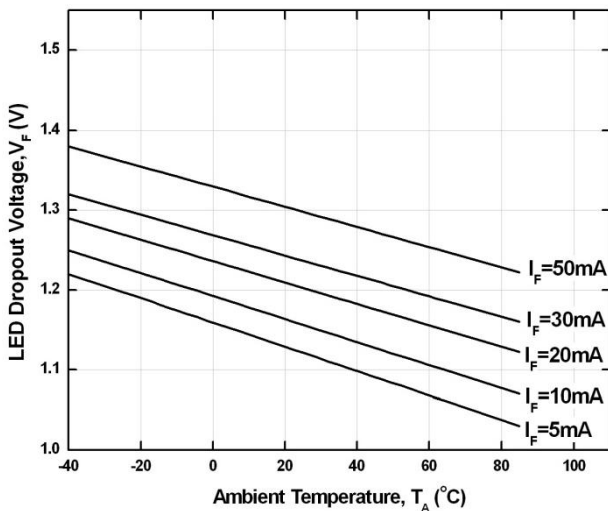

Figure 9-1. Load Voltage vs Load Current

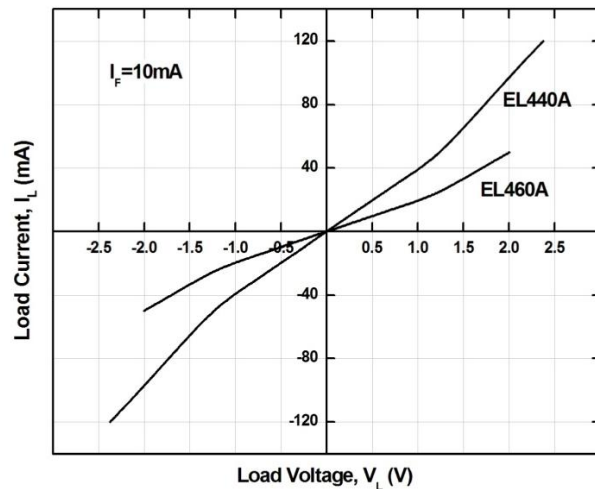

Figure 9-2. Load Voltage vs Load Current

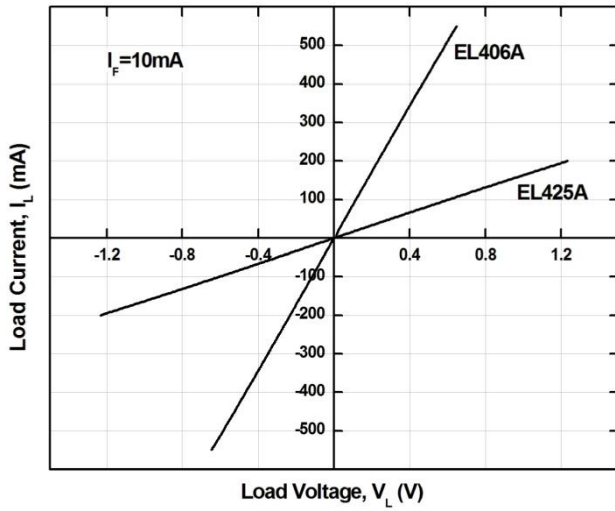

Figure 10. Off State Leakage Current vs Load Voltage

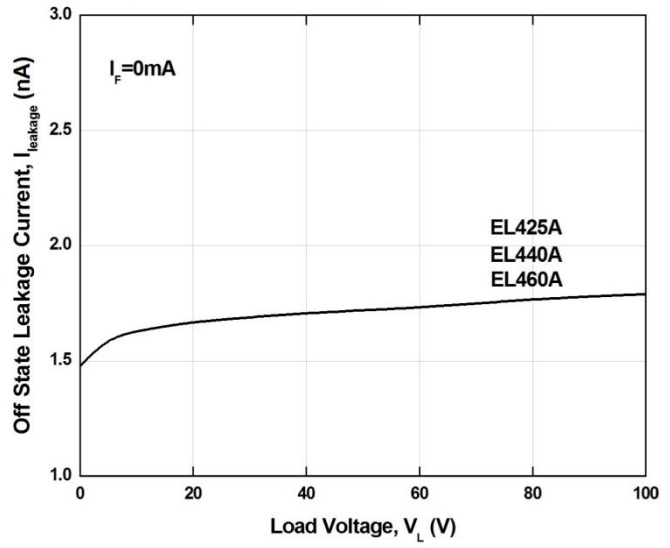
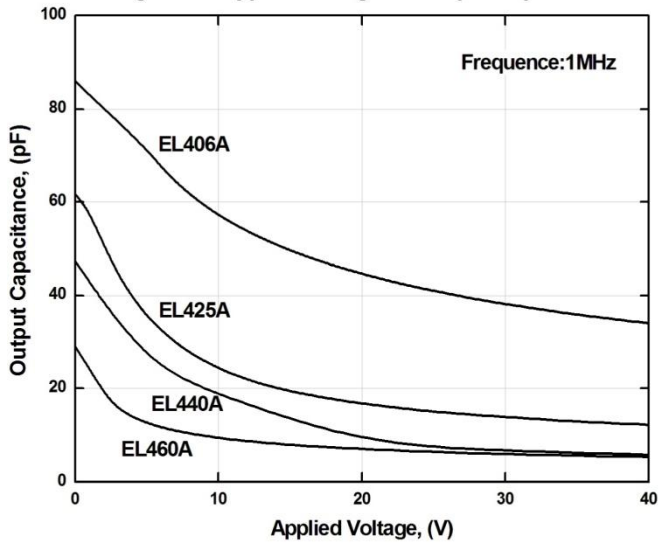

Figure 11. Applied Voltage VS Output Capacitance



Order Information

Part Number

EL4XXA(Y)(Z)-V

Note:

XX = Part No. (06, 25, 40 or 60)

Y = Lead form option (S, S1, M or none)

Z = Tape and reel option (TA, TB, TU, TD or none).

V = VDE safety approved option

Option	Description	Packing quantity
None	Standard DIP-4	100 units per tube
M	Wide lead bend (0.4 inch spacing)	100 units per tube
S (TA)	Surface mount lead form + TA tape & reel option	1000 units per reel
S (TB)	Surface mount lead form + TB tape & reel option	1000 units per reel
S1 (TA)	Surface mount lead form (low profile) + TA tape & reel option	1000 units per reel
S1 (TB)	Surface mount lead form (low profile) + TB tape & reel option	1000 units per reel
S (TU)	Surface mount lead form + TU tape & reel option	1500 units per reel
S (TD)	Surface mount lead form + TD tape & reel option	1500 units per reel
S1 (TU)	Surface mount lead form (low profile) + TU tape & reel option	1500 units per reel
S1 (TD)	Surface mount lead form (low profile) + TD tape & reel option	1500 units per reel

Package Dimension
(Dimensions in mm)

Standard DIP Type

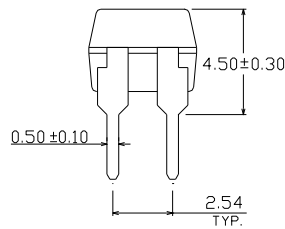
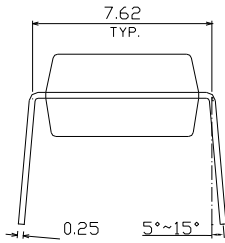
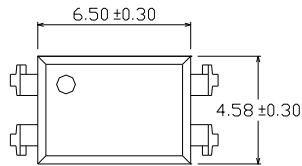

Option M Type

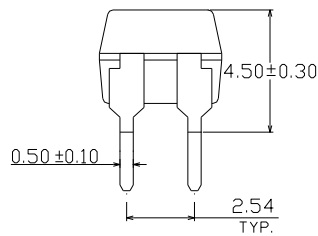
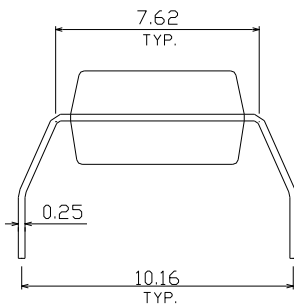
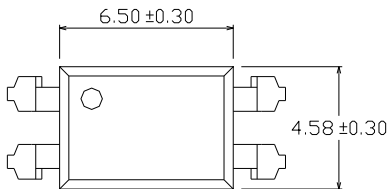

Option S Type

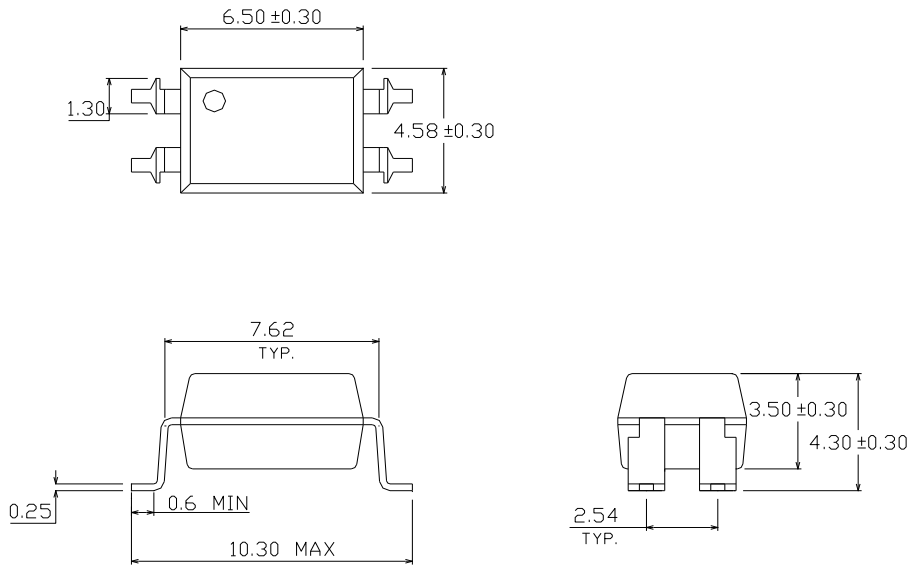

Option S1 Type

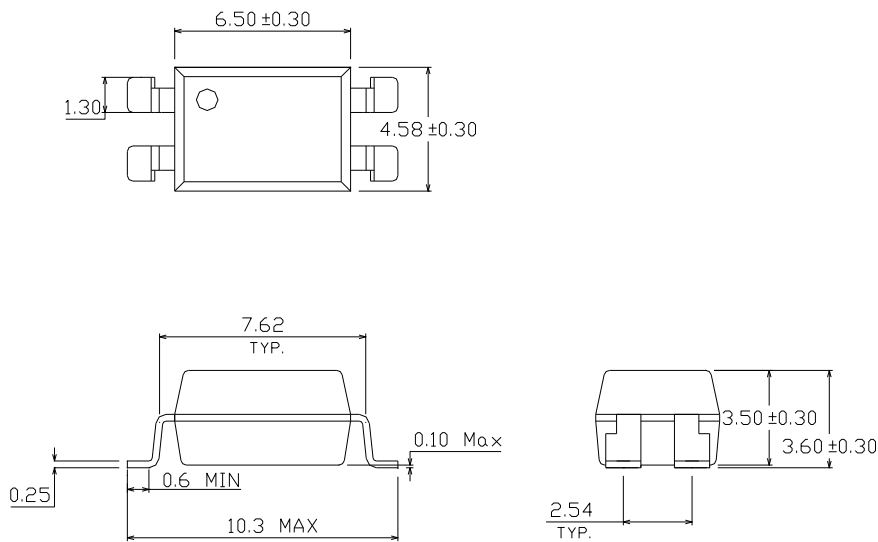

Recommended Pad Layout for Surface Mount Leadform

4Pin SMD

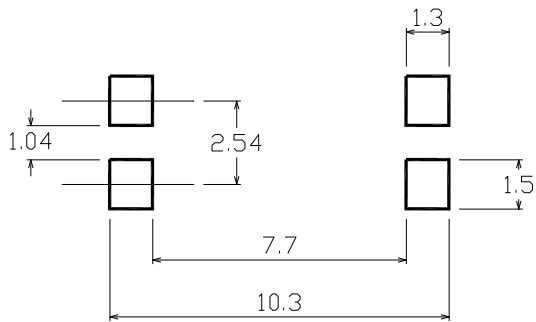

Device Marking



Notes

EL denotes Everlight
440A denotes Part Number
Y denotes 1 digit Year code
WW denotes 2 digit Week code
V denotes VDE option

Tape & Reel Packing Specifications

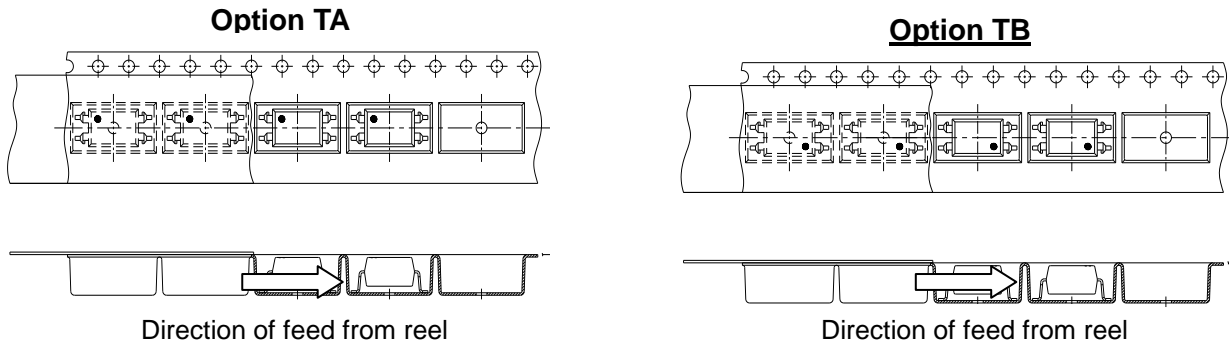

Tape Dimensions

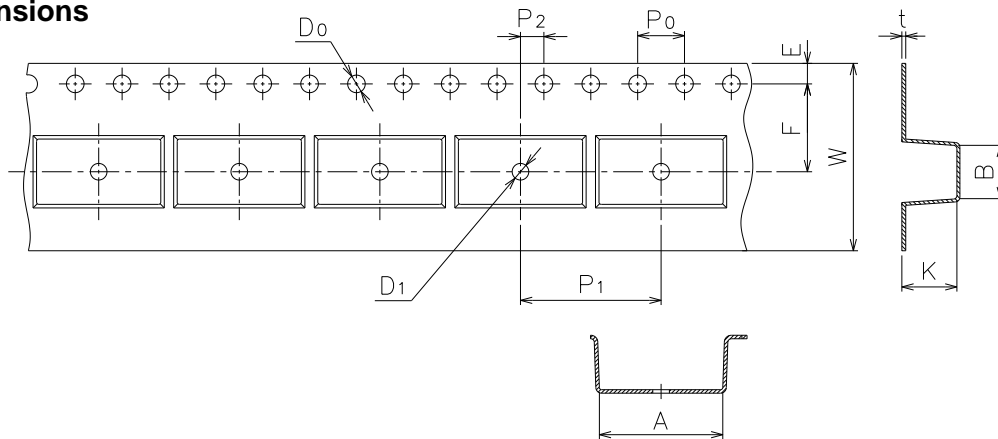

Dimension No.	A	B	Do	D1	E	F
Dimension(mm)	10.4±0.1	4.55±0.1	1.5±0.1	1.5±0.05	1.75±0.1	7.5±0.1
Dimension No.	Po	P1	P2	t	W	K
Dimension(mm)	4.0±0.1	12.0±0.1	2.0±0.1	0.33±0.1	16.0+0.3/ -0.1	4.55±0.1

Option TD

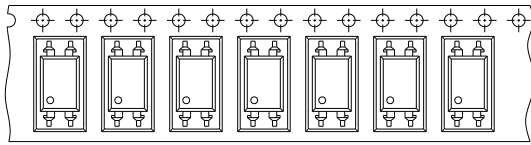

Direction of feed from reel

Option TU

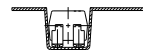
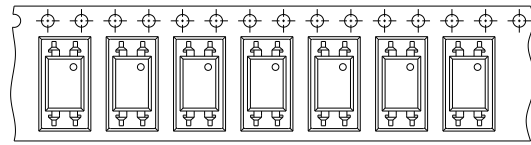

Direction of feed from reel

Tape Dimensions

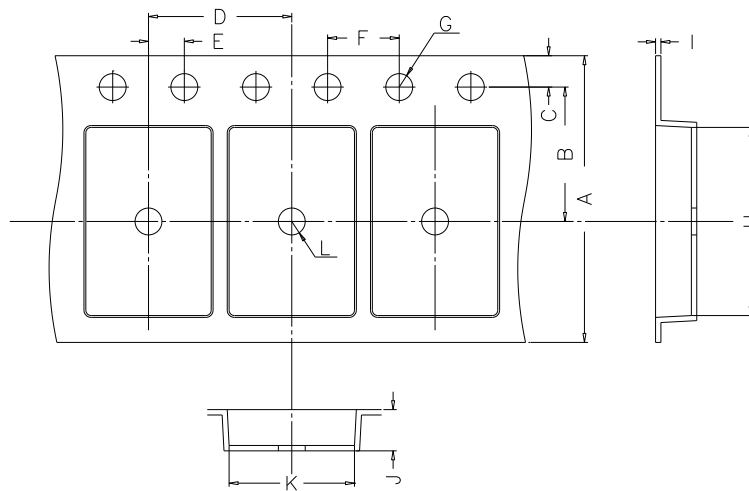

Dimension No.	A	B	C	D	E	F
Dimension(mm)	16.00±0.3	7.5±0.1	1.75±0.1	8.0±0.1	2.0±0.1	4.0±0.1
Dimension No.	G	H	I	J	K	L
Dimension(mm)	1.5+0.1/-0	10.4±0.1	0.4±0.05	4.55±0.1	5.1±0.1	1.5±0.05

Precautions for Use

1. Soldering Condition

1.1 (A) Maximum Body Case Temperature Profile for evaluation of Reflow Profile

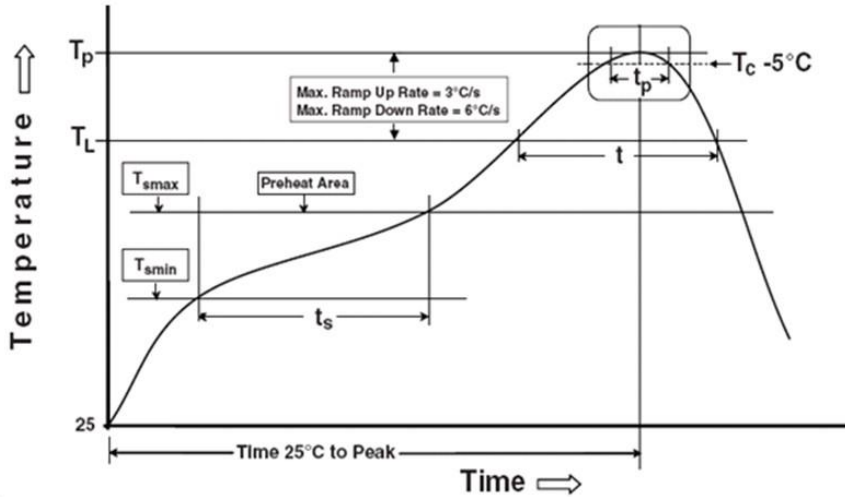

Note:

Reference: IPC/JEDEC J-STD-020D

Preheat

Temperature min (T_{smin})	150 °C
Temperature max (T_{smax})	200°C
Time (T_{smin} to T_{smax}) (t_s)	60-120 seconds
Average ramp-up rate (T_{smax} to T_p)	3 °C/second max

Other

Liquidus Temperature (T_L)	217 °C
Time above Liquidus Temperature (t_L)	60-100 sec
Peak Temperature (T_p)	260°C
Time within 5 °C of Actual Peak Temperature: $T_p - 5^\circ\text{C}$	30 s
Ramp- Down Rate from Peak Temperature	6°C /second max.
Time 25°C to peak temperature	8 minutes max.
Reflow times	3 times

Application Restrictions

High reliability applications such as military/aerospace, automotive safety/security systems, and medical equipment may require different product. If you have any concerns, please contact Everlight before using this product in your application. This specification guarantees the quality and performance of the product as an individual component. Do not use this product beyond the specification described in this document.

单击下面可查看定价，库存，交付和生命周期等信息

[>>Everlight \(亿光\)](#)