

Top view LEDs 67-22/R6BHC-B07/2T



Features

- P-LCC-4 package
- Optical indicator
- Colorless clear window
- Ideal for backlight and light pipe application
- Inter reflector
- Wide viewing angle
- Suitable for vapor-phase reflow.
- Computable with automatic placement equipment
- Available on tape and reel (8mm Tape)
- Pb-free
- The product itself will remain within RoHS compliant version

Applications

- Telecommunication: indicator and backlighting in telephone and fax
- Flat backlight for LCD's, switches and symbols
- Light pipe application
- General use

Device Selection Guide

Chip Materials	Emitted Color	Resin Color
R6	AlGaInP Brilliant Red	Water clear
BH	InGaN Blue	Water clear

Absolute Maximum Ratings (Ta=25°C)

Parameter	Symbol	Rating	Unit
Reverse Voltage	V_R	5	V
Forward Current	I_F	R6 50	mA
		BH 25	
Peak Forward Current	I_{FP}	R6 100	mA
		BH 100	
Power Dissipation	P_d	R6 120	mW
		BH 95	
Operating Temperature	T_{opr}	-40 ~ +85	°C
Storage Temperature	T_{stg}	-40 ~ +90	°C
Soldering Temperature	T_{sol}	Reflow Soldering : 260 °C for 10 sec.	
		Hand Soldering : 350 °C for 3 sec.	

Electro-Optical Characteristics (Ta=25°C)

Parameter	Symbol	Min.	Typ.	Max.	Unit	Condition	
Luminous Intensity	I _v	R6	90	-----	225	mcd	
		BH	90	-----	225		
Viewing Angle	2θ1/2	-----	120	-----	deg	I _F =20mA	
Peak Wavelength	λ _p	R6	-----	632	-----		nm
		BH	-----	468	-----		
Dominant Wavelength	λ _d	R6	621	-----	631		nm
		BH	466.5	-----	471.5		
Spectrum Radiation Bandwidth	Δλ	R6	-----	20	-----		nm
		BH	-----	25	-----		
Forward Voltage	V _F	R6	1.75	-----	2.35	V	
		BH	2.9	-----	3.7		
Reverse Current	I _R	-----	-----	10	μA	V _R =5V	

Note:

1. Tolerance of Luminous Intensity: ±11%
2. Tolerance of Dominant Wavelength: ±1nm
3. Tolerance of Forward Voltage: ±0.1V

Bin Range of Luminous Intensity

Symbol	Bin Code	Min.	Max.	Unit	Condition
R6	Q2	90	112	mcd	I _F =20mA
	R1	112	140		
	R2	140	180		
	S1	180	225		
BH	Q2	90	112		
	R1	112	140		
	R2	140	180		
	S1	180	225		

Bin Range of Dominant Wavelength

Symbol	Bin Code	Min.	Max.	Unit	Condition
R6	FF1	621	626	nm	I _F =20mA
	FF2	626	631		
BH	----	466.5	471.5		

Bin Range of Forward Voltage

Chip	Bin Code	Min.	Max.	Unit	Condition
R6	0	1.75	1.95	V	I _F =20mA
	1	1.95	2.15		
	2	2.15	2.35		
BH	11	2.90	3.10		
	12	3.10	3.30		
	13	3.30	3.50		
	14	3.50	3.70		

1. Tolerance of Luminous Intensity: ±11%
2. Tolerance of Dominant Wavelength: ±1nm
3. Tolerance of Forward Voltage: ±0.1V

Typical Electro-Optical Characteristics Curve (R6)

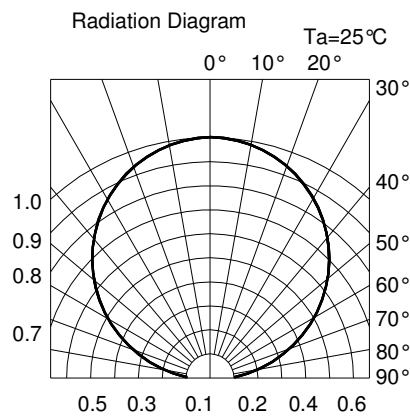
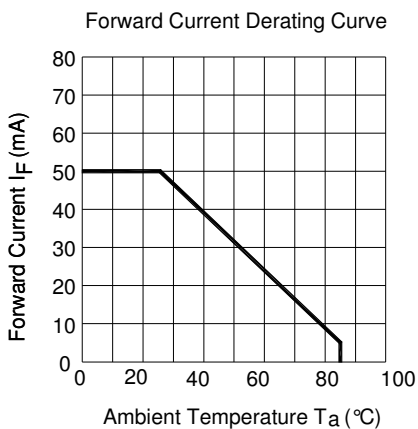
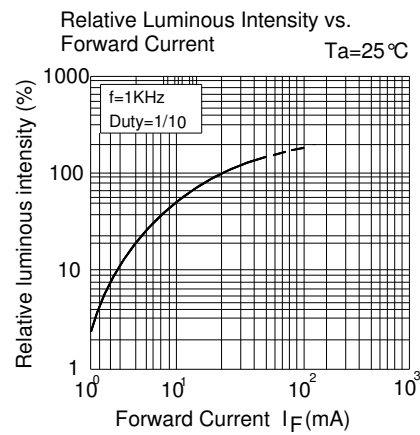
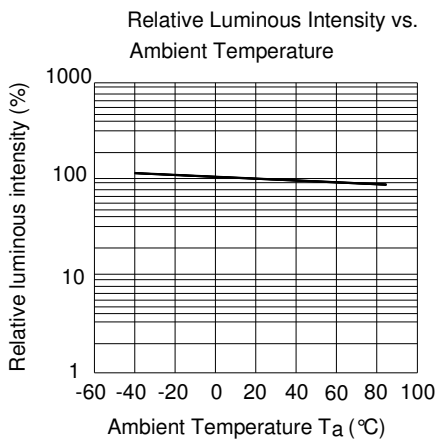
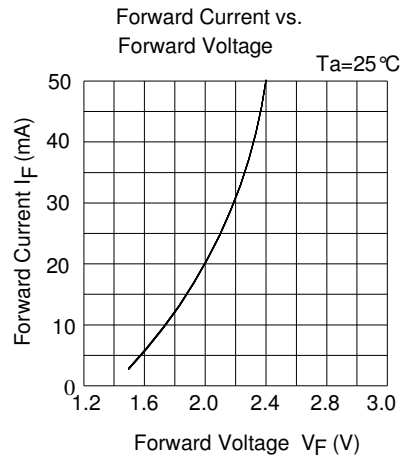
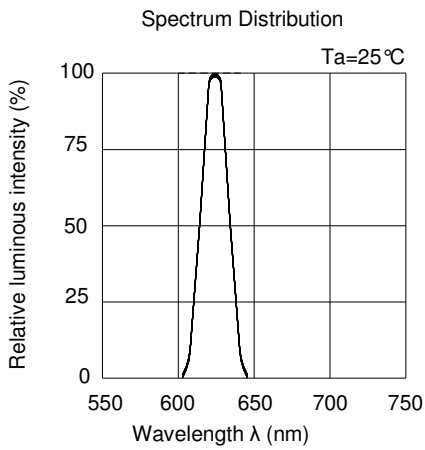

Typical Electro-Optical Characteristics Curves (BH)

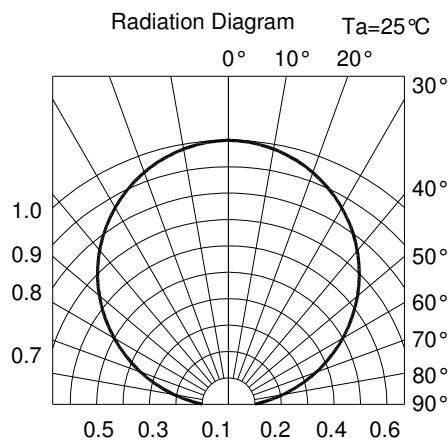
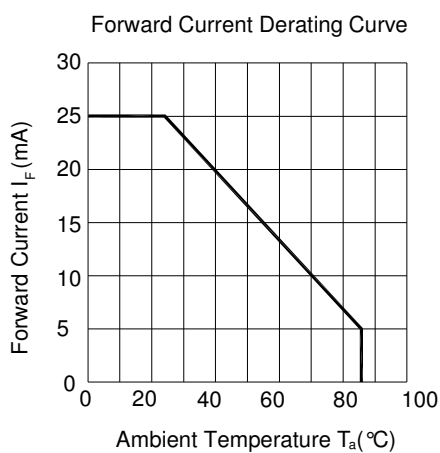
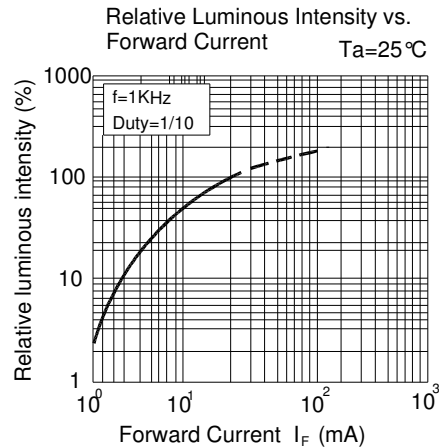
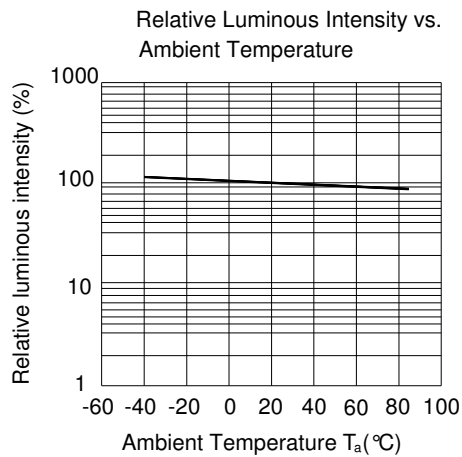
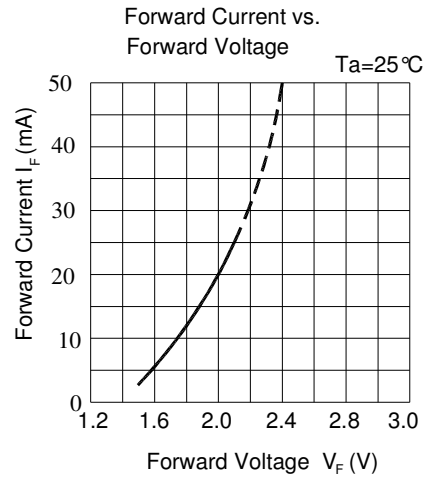
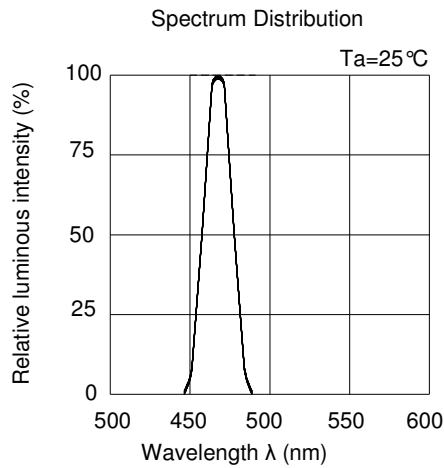

Package Dimension

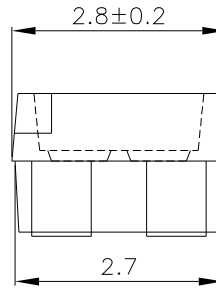
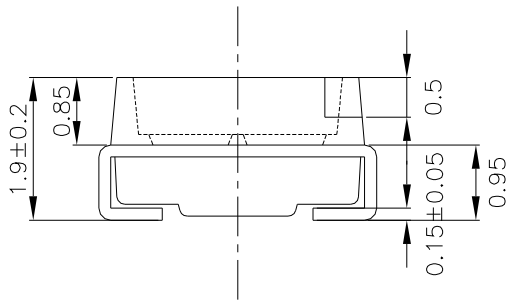
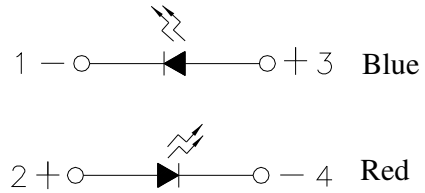
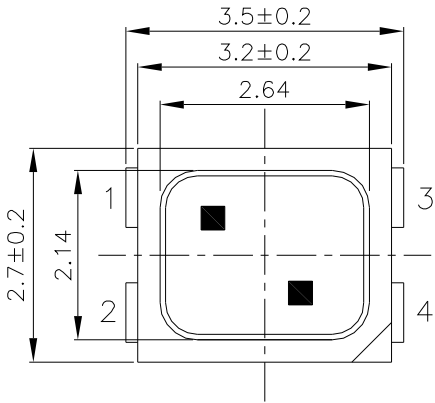

Recommended Solder Pad

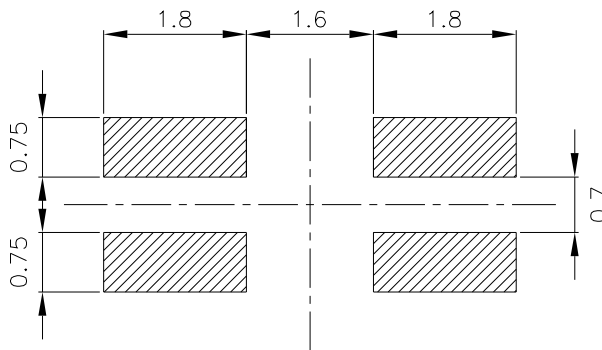
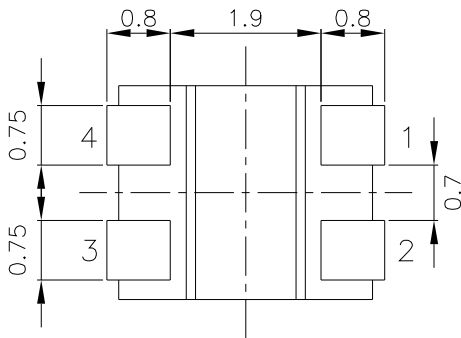

Note: Tolerances unless mentioned ± 0.1 mm. Unit = mm

Moisture Resistant Packing Materials

Label Explanation



- CPN: Customer's Product Number
- P/N: Product Number
- QTY: Packing Quantity
- CAT: Luminous Intensity Rank
- HUE: Dom. Wavelength Rank
- REF: Forward Voltage Rank
- LOT No: Lot Number

Reel Dimensions

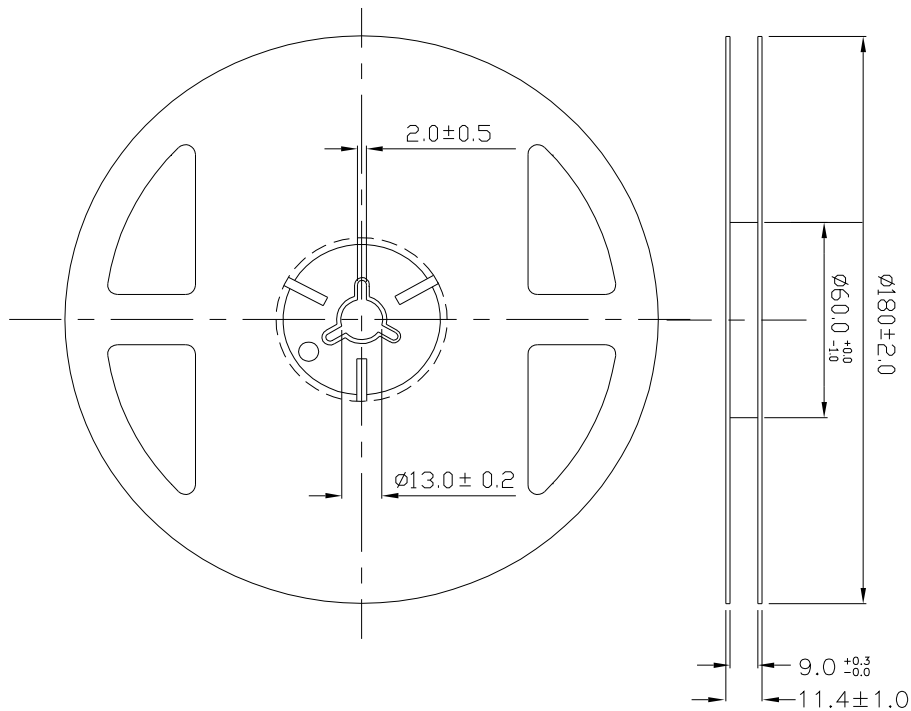

Carrier Tape Dimensions: Loaded Quantity 2000 pcs Per Reel

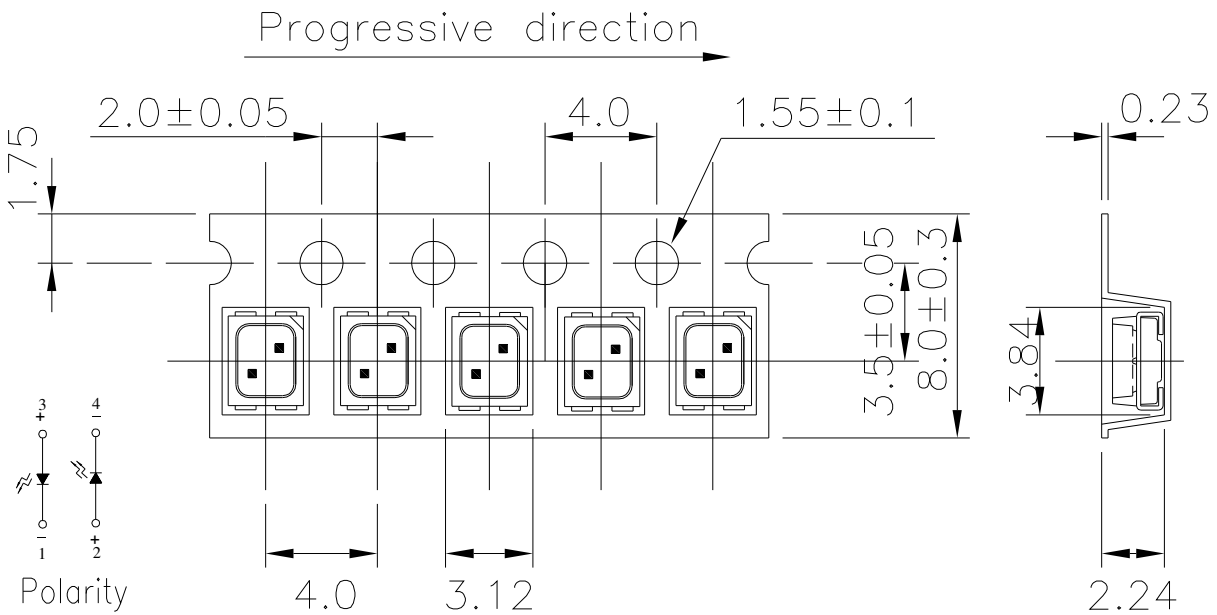

Note: Tolerances unless mentioned ± 0.1 mm. Unit = mm

Moisture Resistant Packing Process

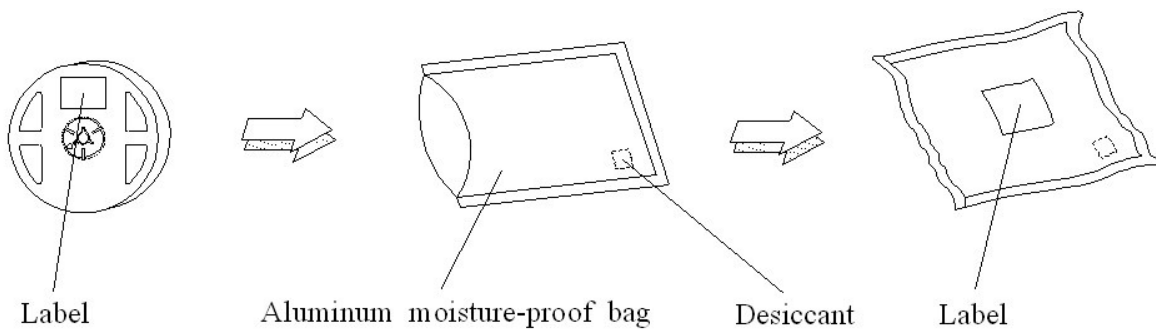

Note: Tolerances unless mentioned ± 0.1 mm. Unit = mm

Precautions for Use

1. Over-current-proof

Customer must apply resistors for protection , otherwise slight voltage shift will cause big current change (Burn out will happen).

2. Storage

2.1 Do not open moisture proof bag before the products are ready to use.

2.2 Before opening the package, the LEDs should be kept at 30°C or less and 90%RH or less.

2.3 After opening the package: The LED's floor life are 168 hours under 30°C or less and 60% RH or less.

If unused LEDs remain, it should be stored in moisture proof packages.

2.4 If the moisture absorbent material (silica gel) has faded away or the LEDs have exceeded the storage time, baking treatment should be performed using the following conditions.

Baking treatment : 60±5°C for 24 hours.

3. Soldering Condition

3.1 Pb-free solder temperature profile

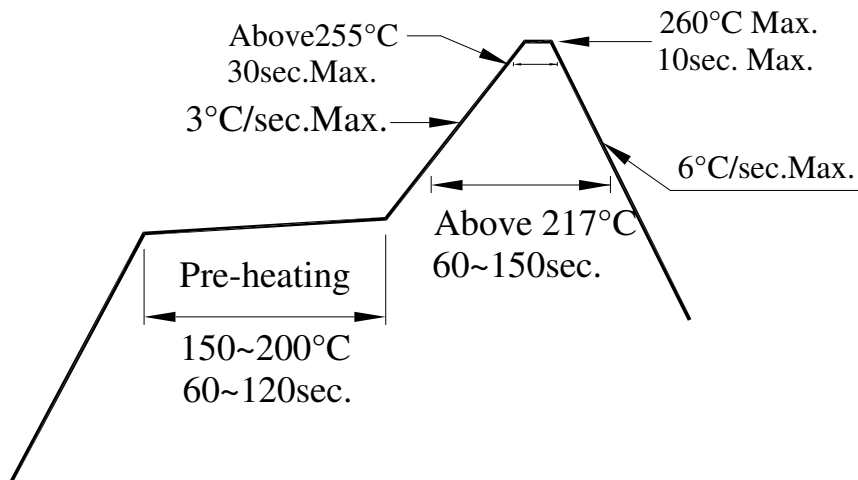

3.2 Reflow soldering should not be done more than two times.

3.3 When soldering, do not put stress on the LEDs during heating.

3.4 After soldering, do not warp the circuit board.

4. Soldering Iron

Each terminal is to go to the tip of soldering iron temperature less than 350°C for 3 seconds within once in less than the soldering iron capacity 25W. Leave two seconds and more intervals, and do soldering of each terminal. Be careful because the damage of the product is often started at the time of the hand solder.

5. Repairing

Repair should not be done after the LEDs have been soldered. When repairing is unavoidable, a double-head soldering iron should be used (as below figure). It should be confirmed beforehand whether the characteristics of the LEDs will or will not be damaged by repairing.

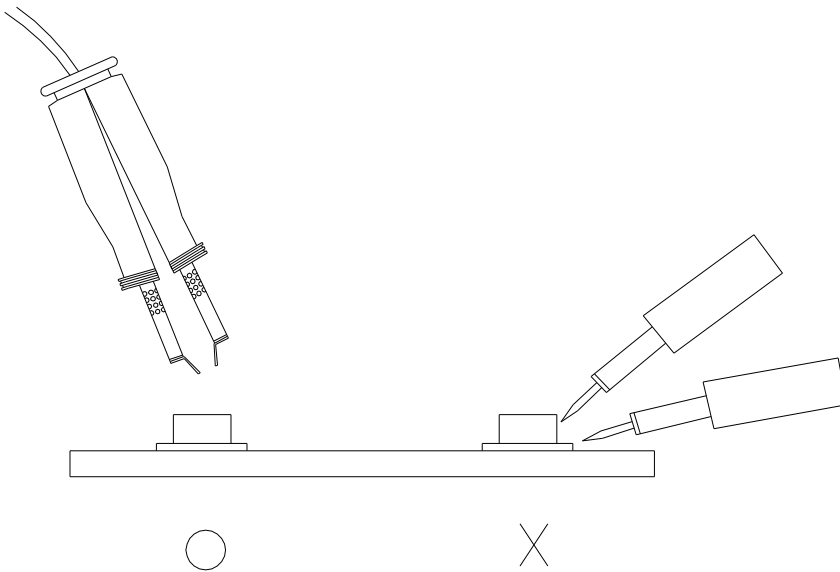

单击下面可查看定价，库存，交付和生命周期等信息

[>>Everlight \(亿光\)](#)