

Technical Data Sheet

Bi-Color (Multi-Color) Top View LEDs

67-22SURSYGC/S530-A2/TR8

Features

- P-LCC-4 package.
- White package
- Optical indicator.
- Colorless clear window.
- Ideal for backlight and light pipe application.
- Inter reflector.
- Low (2mA) current operation.
- Wide viewing angle.
- Computable with automatic placement equipment.
- Suitable for vapor-phase reflow, Infrared reflow and wave solder processes.
- Available on tape and reel (8mm Tape).
- Pb-free
- The product itself will remain within RoHS compliant version.



Descriptions

- The 67-22 series is available in soft orange, green, blue and yellow. Due to the package design, the LED has wide viewing angle and optimized light coupling by inter reflector, this feature makes the SMT TOP LED ideal for light pipe application. The low current requirement makes this device ideal for portable equipment or any other application where power is at a premium.

Applications

- Automotive: backlight in dashboards and switches.
- Telecommunication: indicator and backlight in telephone and fax.
- Indicator and backlight for audio and video equipment.
- Indicator and backlight in office and family equipment.
- Flat backlight for LCD's, switches and symbols.
- Light pipe application.
- General use.

Device Selection Guide

| Chip | | | Lens Color |
|------|----------|------------------------|-------------|
| Type | Material | Emitted Color | |
| SUR | AlGaInP | Deep-Red | Water Clear |
| SYG | AlGaInP | Brilliant Yellow Green | |

Package Dimensions

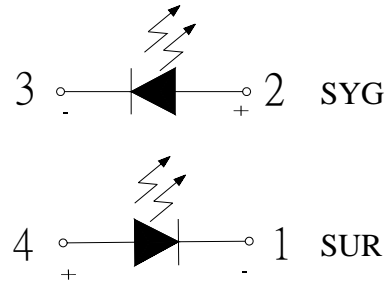
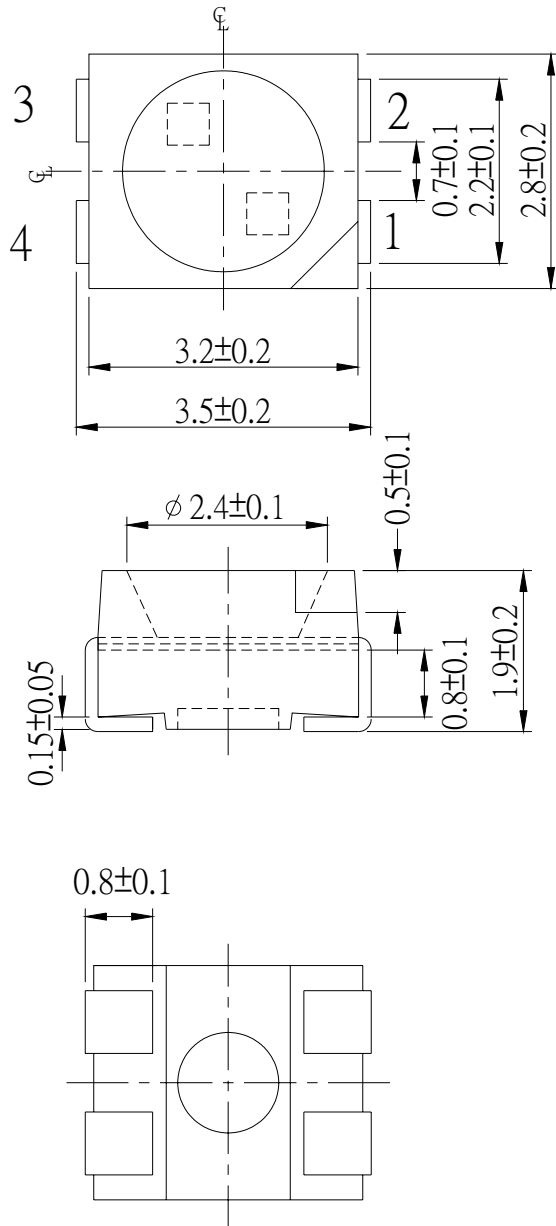

Polarity

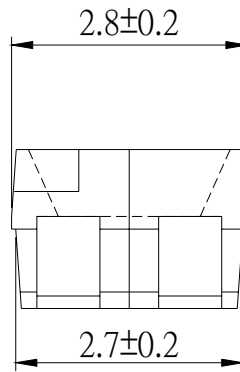

For reflow soldering(propose)

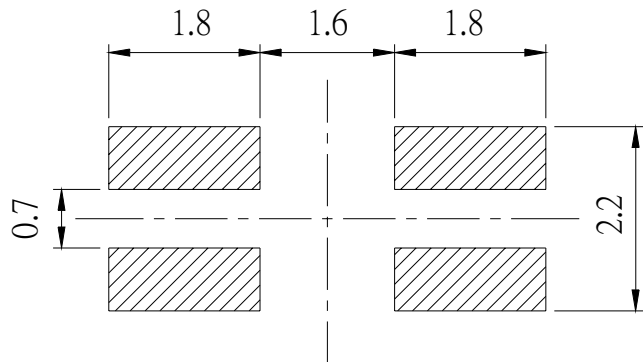

- Notes:**
- 1.All dimensions are in millimeters.
 - 2.Tolerances unspecified are ± 0.1 mm.

Absolute Maximum Ratings (Ta=25°C)

| Parameter | Symbol | Rating | Unit |
|--|------------------|---|------|
| Reverse Voltage | V _R | 5 | V |
| Forward Current | I _F | SUR:25 SYG:25 | mA |
| Operating Temperature | T _{opr} | -40 ~ +85 | °C |
| Storage Temperature | T _{stg} | -40~ +100 | °C |
| Electrostatic Discharge(HBM) | ESD | SUR:2000 SYG:2000 | V |
| Power Dissipation | P _d | SUR:60 SYG:60 | mW |
| Peak Forward Current (Duty 1/10 @ 1KHz) | I _{FP} | SUR:60 SYG:60 | mA |
| Soldering Temperature | T _{sol} | Reflow Soldering : 260 °C for 10 sec. Hand Soldering : 350 °C for 3 sec. | |

Electro-Optical Characteristics (Ta=25°C)

| Parameter | Symbol | Min. | Typ. | Max. | Unit | Condition | |
|------------------------------|----------------|-------|-------|-------|-------|----------------------|----------------------|
| Luminous Intensity | I _v | SUR | 16 | 24 | ----- | mcd | I _F =20mA |
| | | SYG | 24 | 59 | ----- | mcd | |
| Viewing Angle | 2θ 1/2 | ----- | 130 | ----- | deg | I _F =20mA | |
| Peak Wavelength | λ _p | SUR | ----- | 632 | ----- | nm | I _F =20mA |
| | | SYG | ----- | 575 | ----- | | |
| Dominant Wavelength | λ _d | SUR | ----- | 624 | ----- | nm | I _F =20mA |
| | | SYG | ----- | 573 | ----- | | |
| Spectrum Radiation Bandwidth | Δλ | SUR | ----- | 20 | ----- | nm | I _F =20mA |
| | | SYG | ----- | 20 | ----- | | |
| Forward Voltage | V _F | SUR | 1.7 | 2.0 | 2.4 | V | I _F =20mA |
| | | SYG | 1.7 | 2.0 | 2.4 | | |
| Reverse Current | I _R | ----- | ----- | 10 | μA | V _R =5V | |

67-22SURSYGC/S530-A2/TR8

Typical Electro-Optical Characteristics Curves

SUR

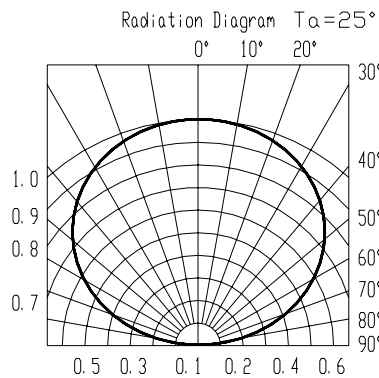
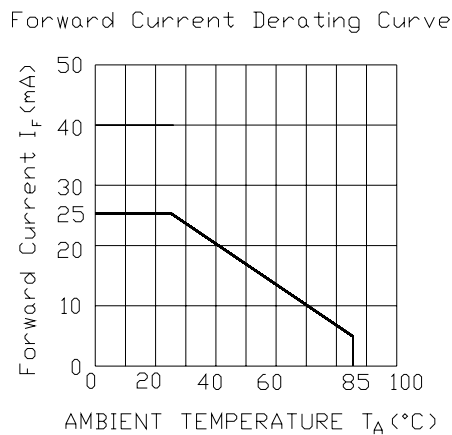
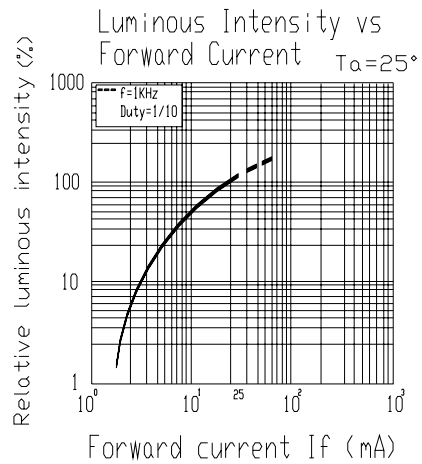
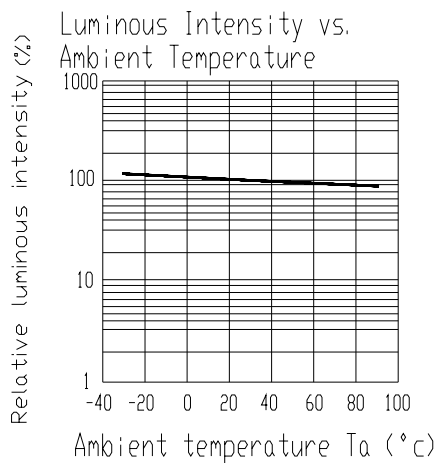
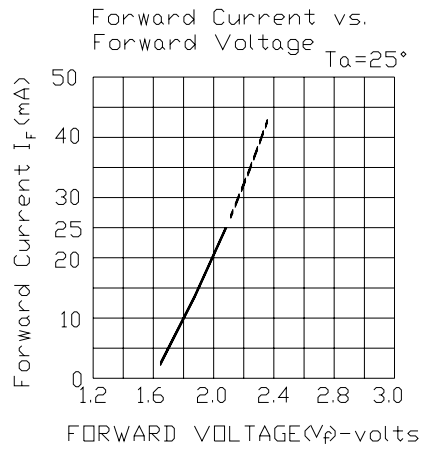
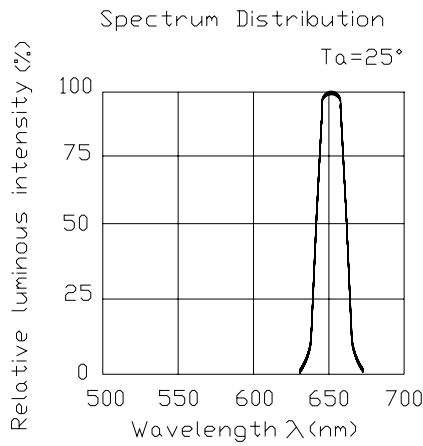

Typical Electro-Optical Characteristics Curves

SYG

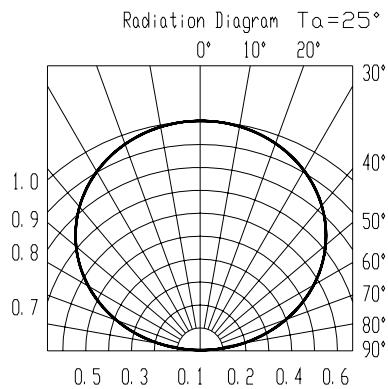
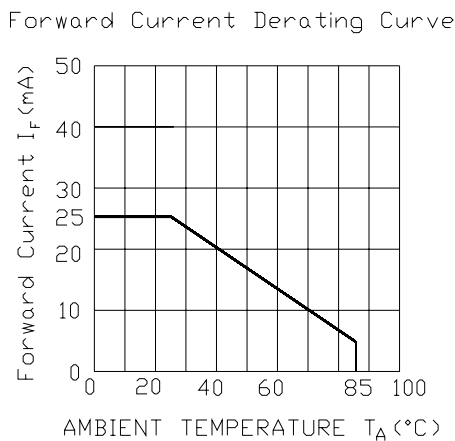
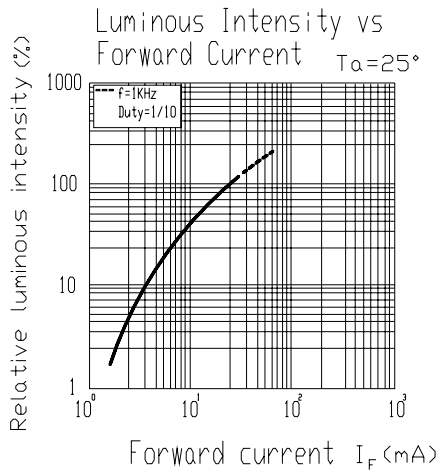
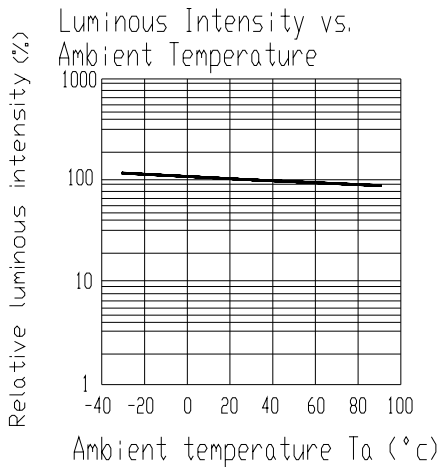
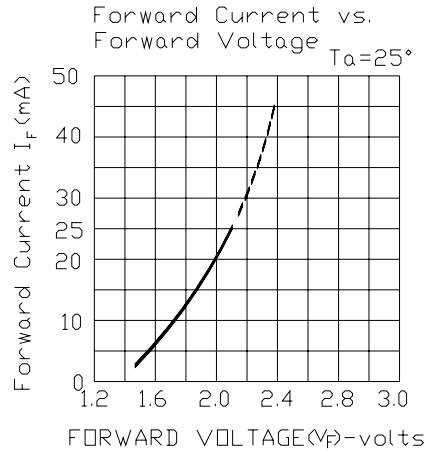
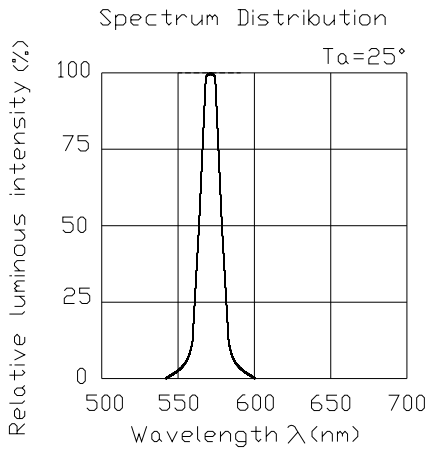



EVERLIGHT ELECTRONICS CO.,LTD
67-22SURSYGC/S530-A2/TR8

Label explanation

CAT: Luminous Intensity Rank

HUE: Dom. Wavelength Rank

REF: Forward Voltage Rank

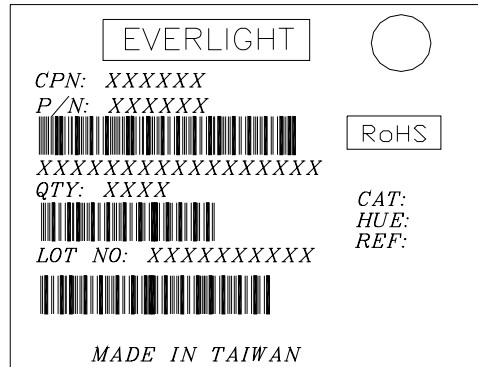

Reel Dimensions

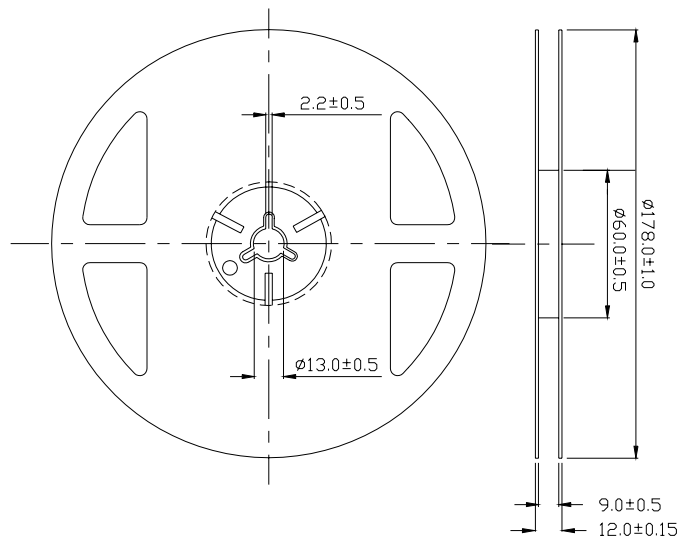

Note: The tolerances unless mentioned is $\pm 0.1\text{mm}$, Unit = mm

Carrier Tape Dimensions: Loaded quantity 2000 PCS per reel

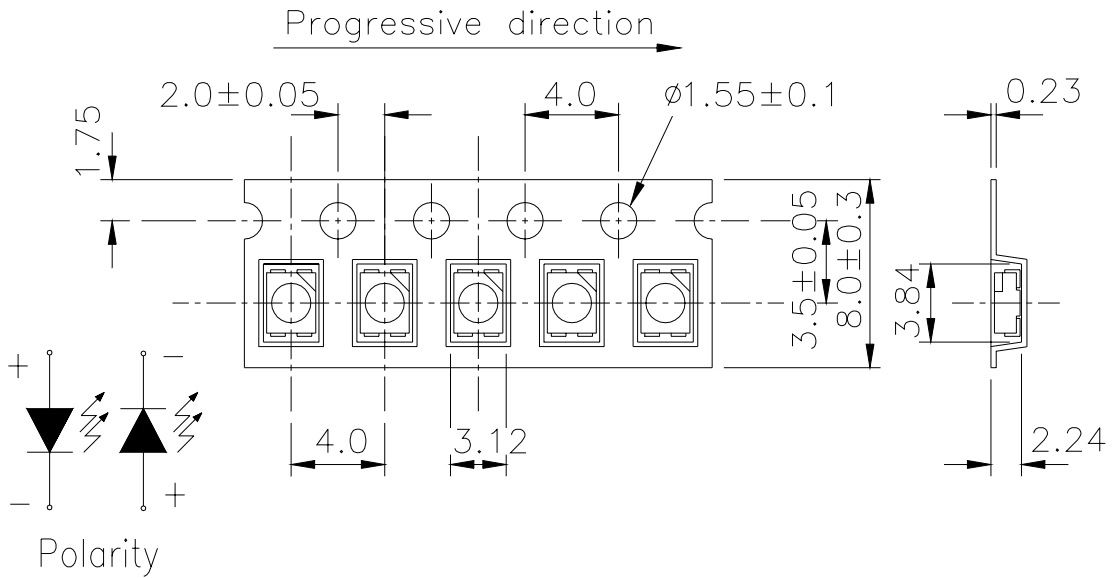

Note: The tolerances unless mentioned is $\pm 0.1\text{mm}$, Unit = mm

Moisture Resistant Packaging

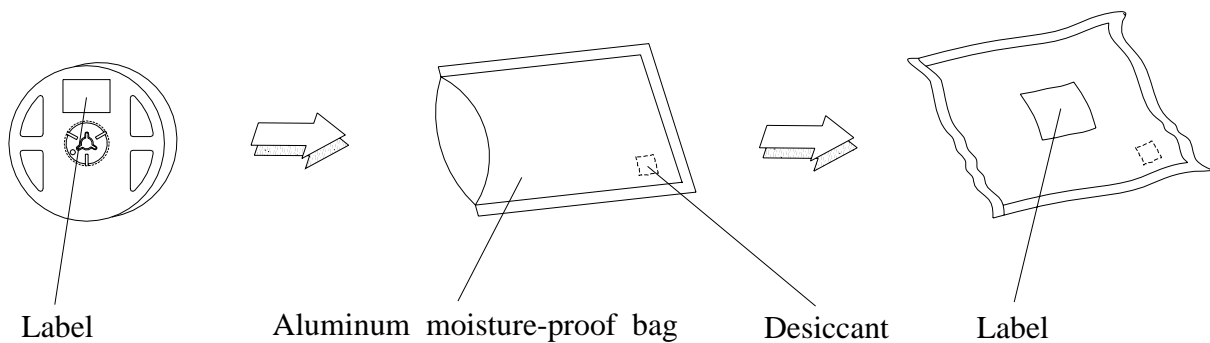

**Reliability Test Items And Conditions**

The reliability of products shall be satisfied with items listed below.

Confidence level : 90%

LTPD : 10%

| No. | Items | Test Condition | Test Hours/Cycles | Sample Size | Ac/Re |
|-----|----------------------------------|--|-------------------|-------------|-------|
| 1 | Reflow Soldering | Temp. : 260°C ±5°C Min. 5sec. | 6 Min. | 22 PCS. | 0/1 |
| 2 | Temperature Cycle | H : +100°C 15min ∫ 5 min L : -40°C 15min | 300 Cycles | 22 PCS. | 0/1 |
| 3 | Thermal Shock | H : +100°C 5min ∫ 10 sec L : -10°C 5min | 300 Cycles | 22 PCS. | 0/1 |
| 4 | High Temperature Storage | Temp. : 100°C | 1000 Hrs. | 22 PCS. | 0/1 |
| 5 | Low Temperature Storage | Temp. : -40°C | 1000 Hrs. | 22 PCS. | 0/1 |
| 6 | DC Operating Life | IF = 20 mA | 1000 Hrs. | 22 PCS. | 0/1 |
| 7 | High Temperature / High Humidity | 85°C / 85%RH | 1000 Hrs. | 22 PCS. | 0/1 |

Precautions For Use

1. Over-current-proof

Customer must apply resistors for protection , otherwise slight voltage shift will cause big current change (Burn out will happen).

2. Storage

2.1 Do not open moisture proof bag before the products are ready to use.

2.2 Before opening the package, the LEDs should be kept at 30°C or less and 90%RH or less.

2.3 The LEDs should be used within a year.

2.4 After opening the package, the LEDs should be kept at 30°C or less and 70%RH or less.

2.5 The LEDs should be used within 168 hours (7 days) after opening the package.

2.6 If the moisture absorbent material (silica gel) has faded away or the LEDs have exceeded the storage time, baking treatment should be performed using the following conditions.

Baking treatment : 60±5°C for 24 hours.

3. Soldering Condition

3.1 Pb-free solder temperature profile

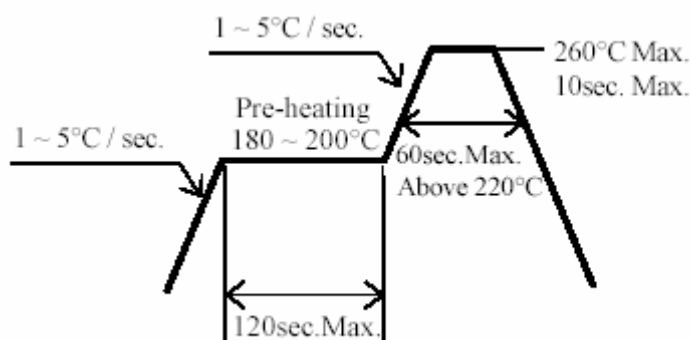

3.2 Reflow soldering should not be done more than two times.

3.3 When soldering, do not put stress on the LEDs during heating.

3.4 After soldering, do not warp the circuit board.

4.Soldering Iron

Each terminal is to go to the tip of soldering iron temperature less than 350°C for 3 seconds within once in less than the soldering iron capacity 25W. Leave two seconds and more intervals, and do soldering of each terminal. Be careful because the damage of the product is often started at the time of the hand solder.

5.Repairing

Repair should not be done after the LEDs have been soldered. When repairing is unavoidable, a double-head soldering iron should be used (as below figure). It should be confirmed beforehand whether the characteristics of the LEDs will or will not be damaged by repairing.

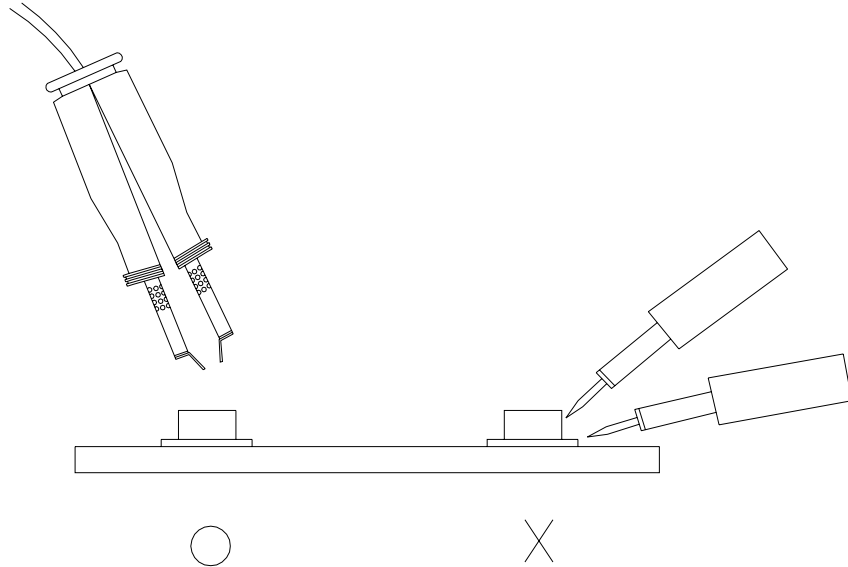

EVERLIGHT ELECTRONICS CO., LTD.
Office: No 25, Lane 76, Sec 3, Chung Yang Rd,
Tucheng, Taipei 236, Taiwan, R.O.C

Tel: 886-2-2267-2000, 2267-9936
Fax: 886-2267-6244, 2267-6189, 2267-6306
<http://www.everlight.com>

单击下面可查看定价，库存，交付和生命周期等信息

[>>Everlight \(亿光\)](#)