

EL TOP VIEW LED A09K-C71501H-AM

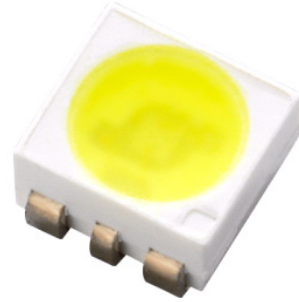

Features

- Package : PLCC 6 package
- Color : Cool White
- Typ. Luminance Intensity : 10000 mcd @ 150mA
- Viewing angle : 120°
- ESD : 8KV
- MSL : 2
- Typ.color coordinates : (0.3,0.3)
- Qualified AEC-Q101
- Compliance with RoHS and REACH
- Sulfur robustness

Applications

- Automotive exterior lighting
- Automotive interior lighting

Contents

1. Characteristics	3
2. Absolute Maximum Ratings	4
3. Characteristics Graph	5
4. Binning Information	10
5. Part Number.....	14
6. Ordering Information	15
7. Mechanical Dimension.....	16
8. Recommended Soldering Pad.....	17
9. Reflow Soldering Profile.....	17
10. Packaging Information.....	18
11. Precaution for Use	20

1. Characteristics

Parameter	Symbol	Min.	Typ.	Max.	Unit	Condition
Forward Current	I_F	20	150	200	mA	---
Luminous Intensity	I_v	7100	10000	18000	mcd	$I_F=150\text{mA}$
Forward Voltage	V_F	2.50	3.2	3.75	V	$I_F=150\text{mA}$
Viewing Angle	ϕ	---	120	---	deg	$I_F=150\text{mA}$
Color	CIE x	---	0.3	---		$I_F=150\text{mA}$
Color	CIE y	---	0.3	---	---	$I_F=150\text{mA}$
Thermal Resistance (Junction to Solder)	Real	$R_{th\ JS\ real}$	---	---	40	K/W $I_F=150\text{mA}$
	Electrical	$R_{th\ JS\ el}$	---	---	30	

Notes:

1. Luminous Flux measurement tolerance: $\pm 8\%$.
2. The data of Luminous Flux measured at thermal pad=25°C
3. Forward voltage measurement tolerance: $\pm 0.05\text{V}$
4. The V_F range shown in the table above indicates 99% output.
5. Tolerance of Chromaticity Coordinates x,y : ± 0.005

2. Absolute Maximum Ratings

Parameter	Symbol	Ratings	Unit
Power Dissipation	P_d	750	mW
Forward Current	I_F	200	mA
Surge Current ($t \leq 10 \mu\text{s}$; $D=0.005$; $T_s=25^\circ\text{C}$)	I_{FM}	750	mA
Reverse Voltage	V_R	Not designed for reverse operation	V
Junction Temperature	T_J	125	$^\circ\text{C}$
Operating Temperature	T_{opr}	-40 ~ +110	$^\circ\text{C}$
Storage Temperature	T_{stg}	-40 ~ +110	$^\circ\text{C}$
ESD Sensitivity ($R=1.5\text{k}\Omega$, $C=100\text{pF}$)	ESD_{HBM}	8	kV
Soldering Temperature	Reflow	260 $^\circ\text{C}$ for 30sec	$^\circ\text{C}$

3. Characteristics Graph

Wavelength Characteristics Relative Spectral Distribution
@ Ts = 25 °C, If=150mA

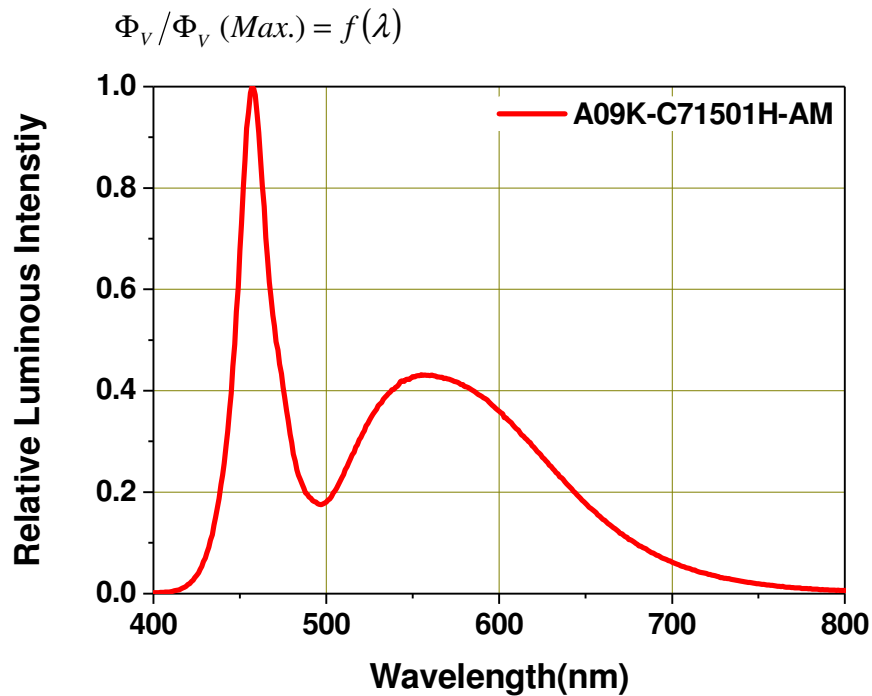

Typical Diagram Characteristics of Radiation

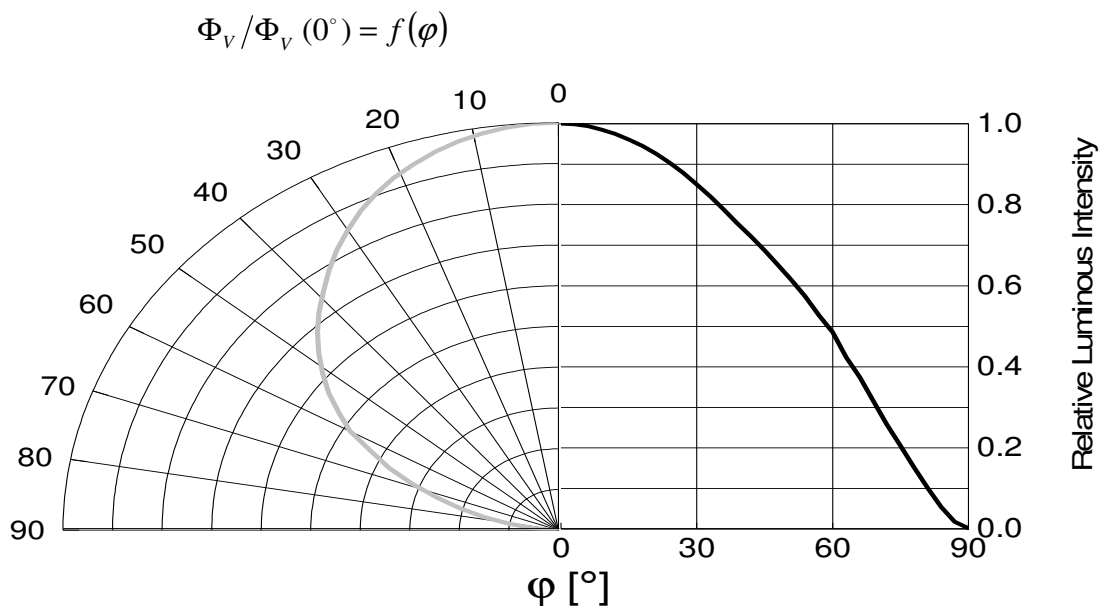

Notes:

1. φ is the off axis angle from lamp centerline where the luminous intensity is 1/2 of the peak value.
2. View angle tolerance is $\pm 5^\circ$.

Forward Current vs. Forward Voltage @ Ts = 25°C

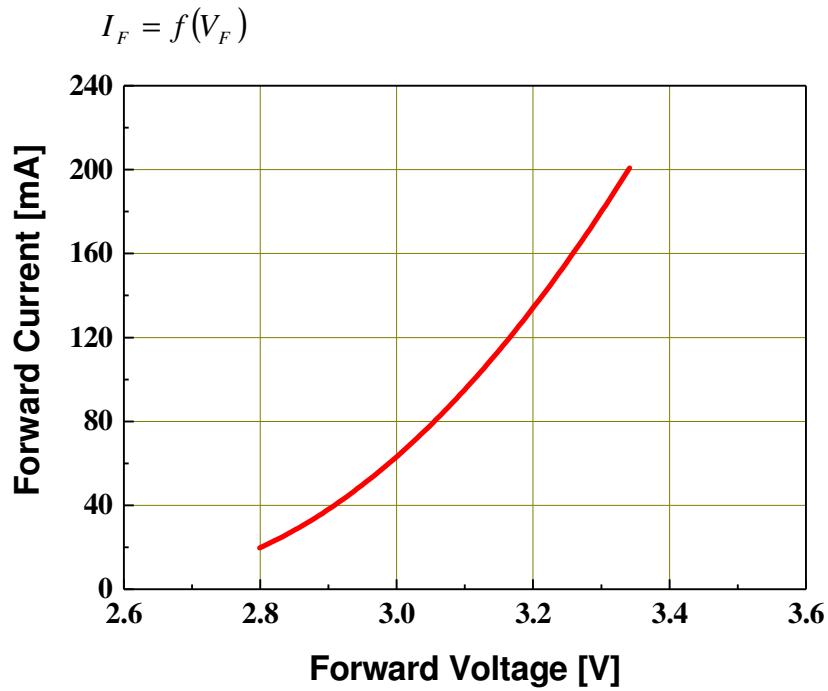

Relative Luminous Intensity vs. Forward Current @ Ts = 25°C

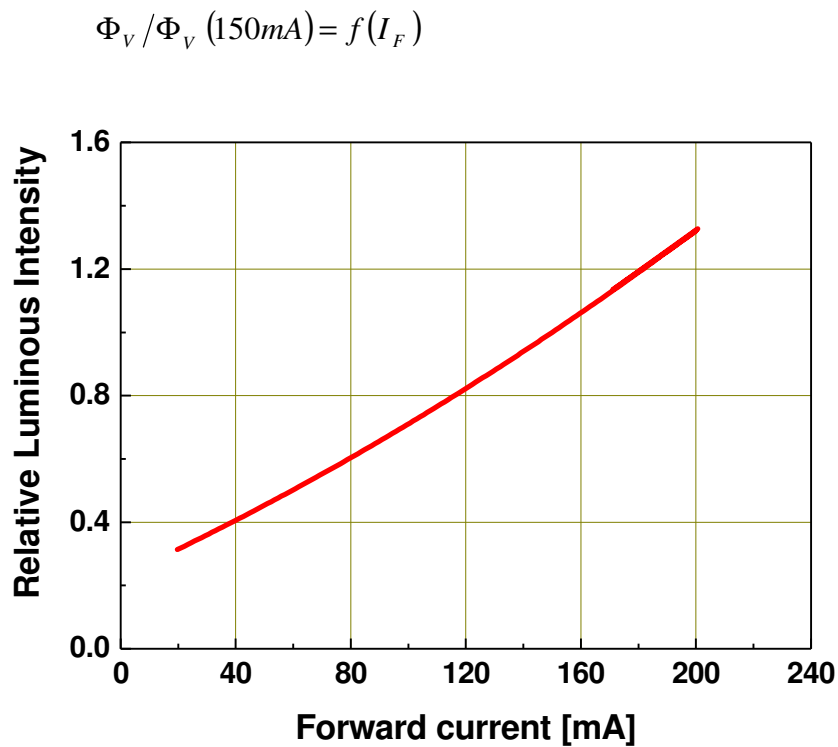

Chromaticity Coordinates Shift vs. Forward Current

@ $T_s = 25^\circ\text{C}$

$$\Delta CIE\ x, \Delta CIE\ y = f(I_F)$$

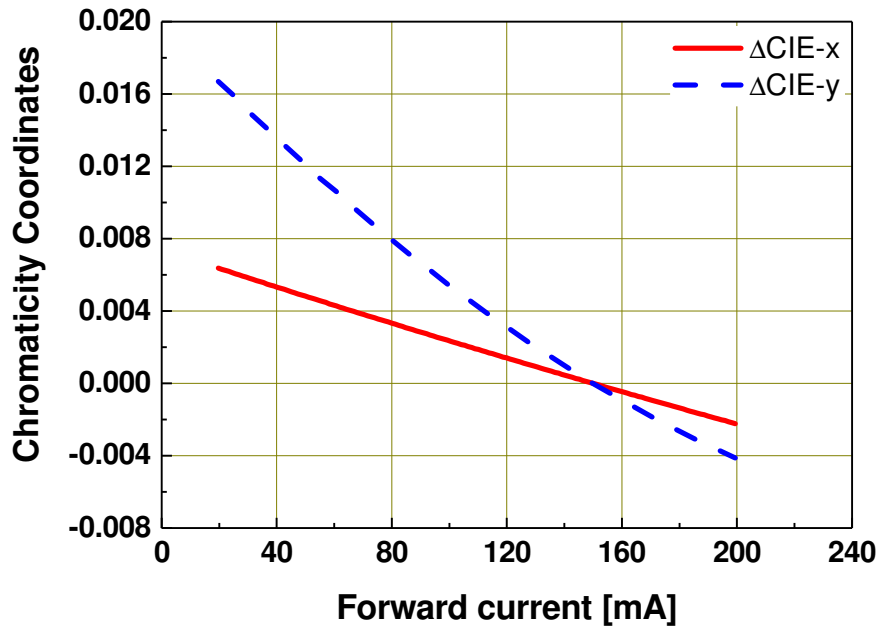

Relative Forward Voltage vs. Junction Temperature

@ $I_F = 150\text{mA}$

$$\Delta V_F = V_F - V_F(25^\circ\text{C}) = f(T_j)$$

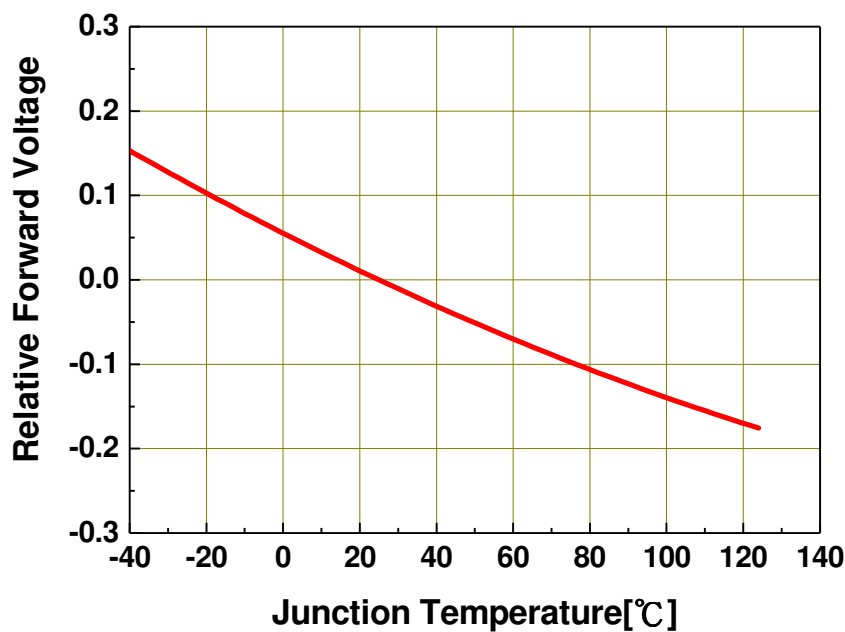

Relative Luminous Intensity vs. Junction Temperature

@ I_F=150mA

$$\Phi_v / \Phi_v(25^\circ C) = f(T_j)$$

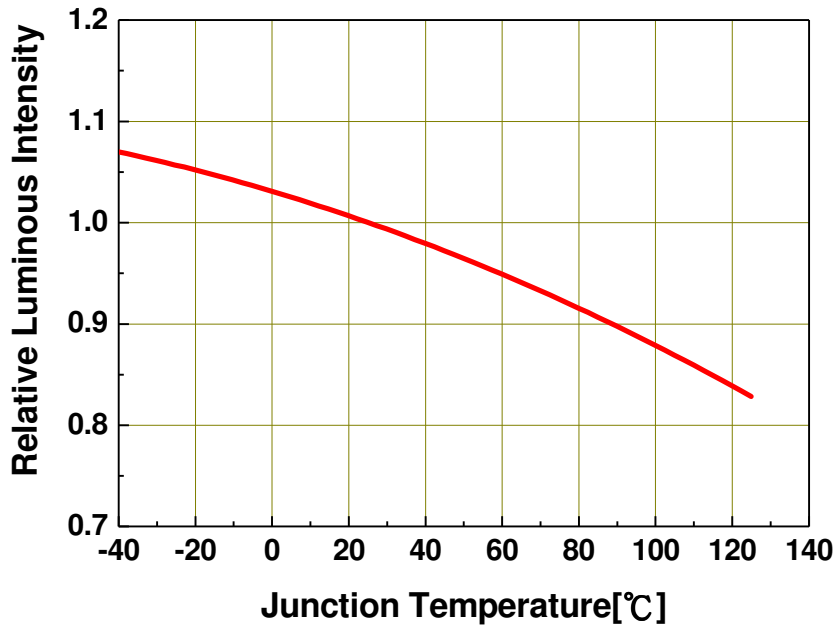

Chromaticity Coordinates Shift vs. Junction Temperature

@ I_F=150mA

$$\Delta CIE x, \Delta CIE y = f(T_j)$$

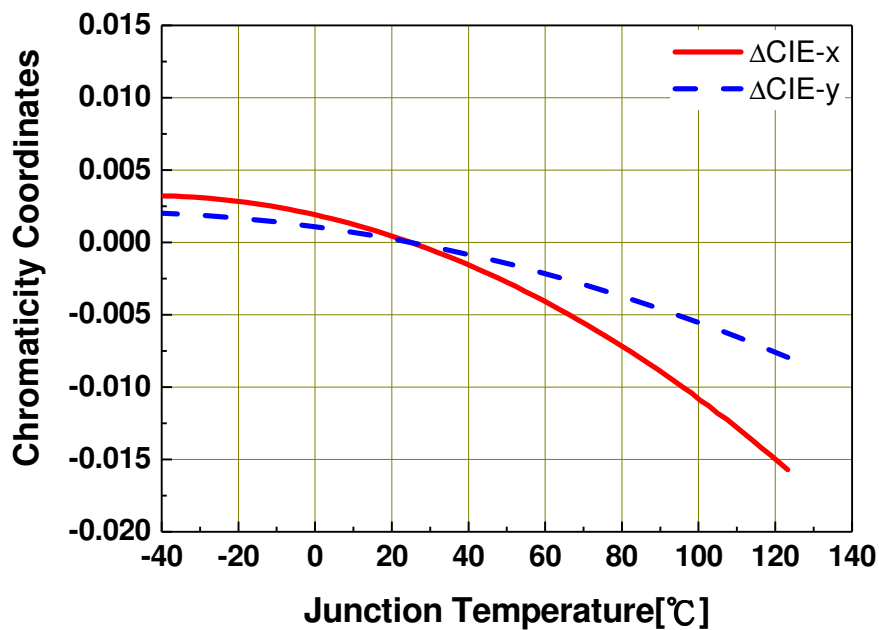

Forward Current Derating Curve

$$I_F = f(T_S)$$

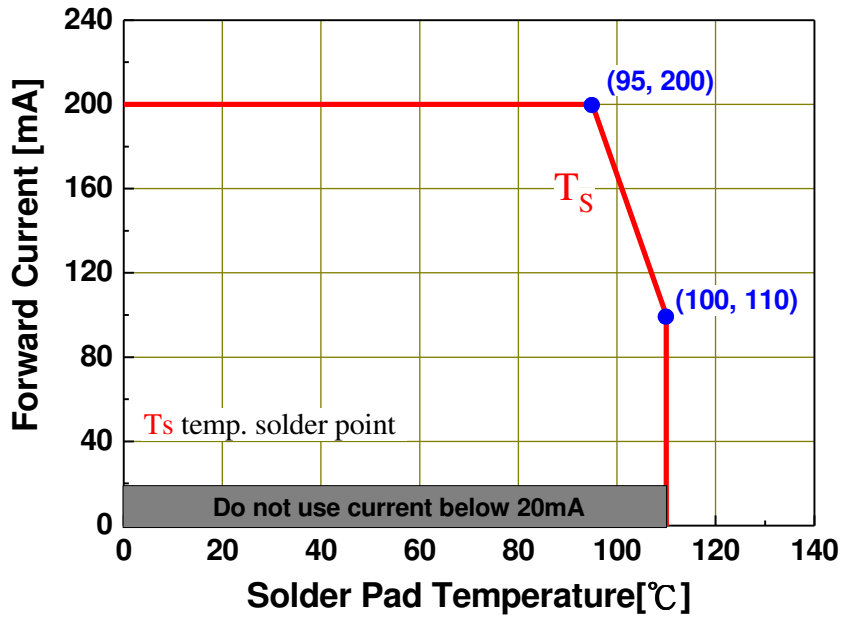

Permissible Pulse Handling Capability

D=Duty cycle, $T_s = 25^\circ\text{C}$

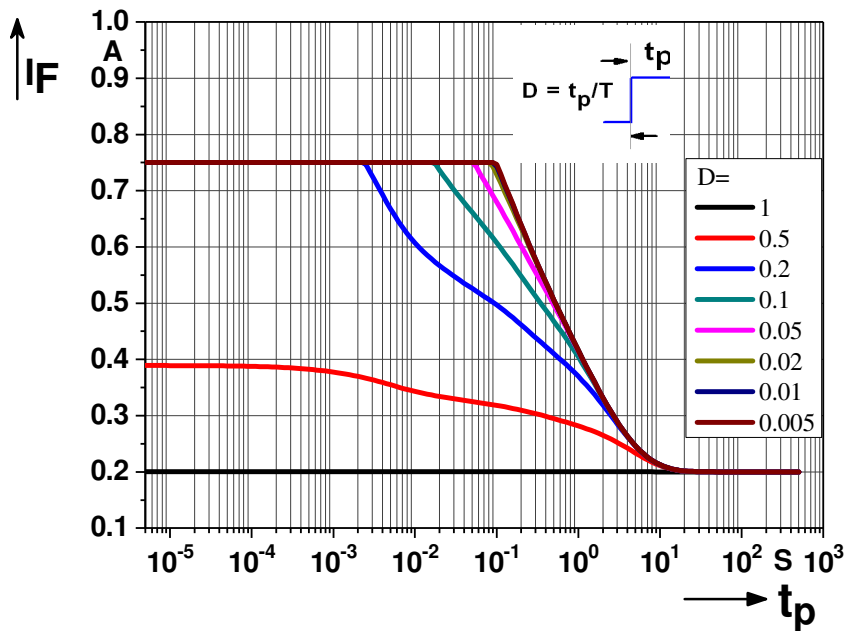

4. Binning Information

Luminous Intensity Bins

Group Bin	Minimum Luminous Intensity (mcd)	Maximum Luminous Intensity (mcd)
L1	11.2	14
L2	14	18
M1	18	22.4
M2	22.4	28
N1	28	35.5
N2	35.5	45
P1	45	56
P2	56	71
Q1	71	90
Q2	90	112
R1	112	140
R2	140	180
S1	180	224
S2	224	280
T1	280	355
T2	355	450
U1	450	560
U2	560	710
V1	710	900
V2	900	1120
AA	1120	1400
AB	1400	1800
BA	1800	2240
BB	2240	2800
CA	2800	3550
CB	3550	4500
DA	4500	5600
DB	5600	7100
EA	7100	9000
EB	9000	11200
FA	11200	14000
FB	14000	18000
GA	18000	22400

Notes:

1. Luminous flux measurement tolerance: $\pm 8\%$.
2. Highlighted Black Box is possible output bins.

Standard White Color Bin Structure

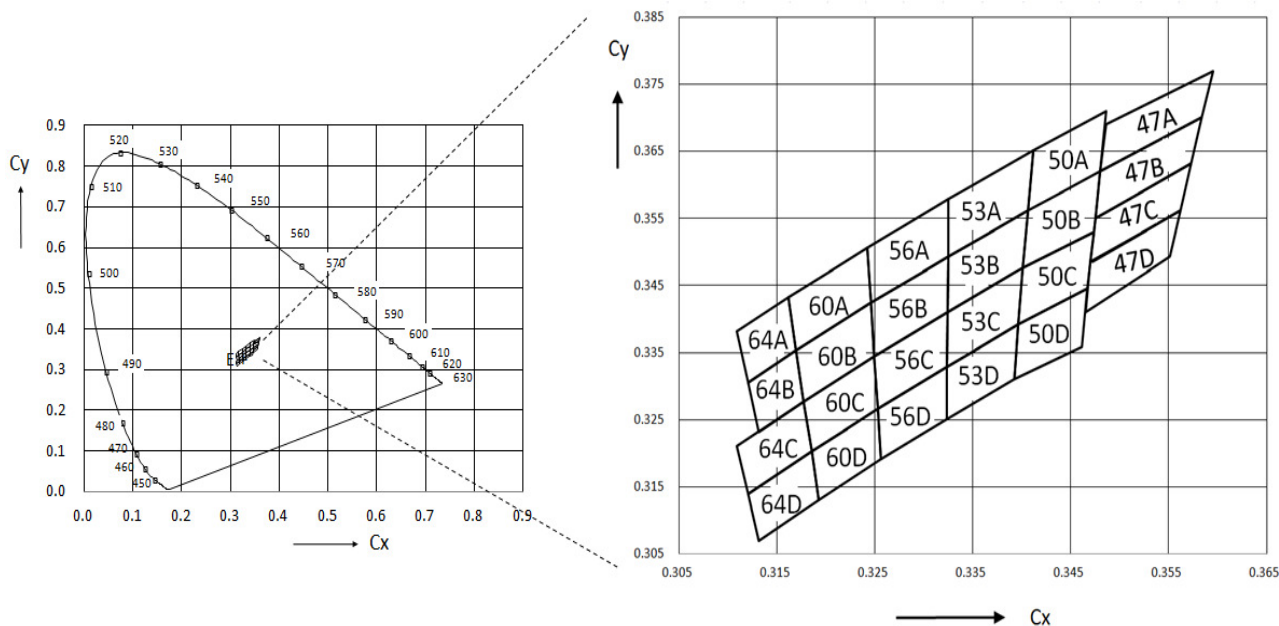

White Color Bin Coordinates

Bin	CIE x	CIE y
64A	0.3109	0.3382
	0.3161	0.3432
	0.3169	0.3353
	0.3120	0.3306
Reference Range: 6240~6530K		

Bin	CIE x	CIE y
64B	0.3120	0.3306
	0.3169	0.3353
	0.3177	0.3277
	0.3131	0.3232
Reference Range: 6240~6530K		

Bin	CIE x	CIE y
64C	0.3109	0.3211
	0.3177	0.3277
	0.3185	0.3203
	0.3120	0.3139
Reference Range: 6240~6680K		

Bin	CIE x	CIE y
64D	0.3120	0.3139
	0.3185	0.3203
	0.3192	0.3131
	0.3131	0.3070
Reference Range: 6240~6680K		

Bin	CIE x	CIE y
60A	0.3161	0.3432
	0.3242	0.3506
	0.3246	0.3424
	0.3169	0.3353
Reference Range: 5850~6240K		

Bin	CIE x	CIE y
60B	0.3169	0.3353
	0.3246	0.3424
	0.3249	0.3344
	0.3177	0.3277
Reference Range: 5850~6240K		

Bin	CIE x	CIE y
60C	0.3177	0.3277
	0.3249	0.3344
	0.3253	0.3266
	0.3185	0.3203
Reference Range: 5850~6240K		

Bin	CIE x	CIE y
60D	0.3185	0.3203
	0.3253	0.3266
	0.3256	0.3191
	0.3192	0.3131
Reference Range: 5850~6240K		

White Color Bin Coordinates

Bin	CIE x	CIE y
56A	0.3242	0.3506
	0.3325	0.3579
	0.3325	0.3493
	0.3246	0.3424
Reference Range: 5500~5850K		

Bin	CIE x	CIE y
56B	0.3246	0.3424
	0.3325	0.3493
	0.3324	0.3410
	0.3249	0.3344
Reference Range: 5500~5850K		

Bin	CIE x	CIE y
56C	0.3249	0.3344
	0.3324	0.3410
	0.3323	0.3329
	0.3253	0.3266
Reference Range: 5500~5850K		

Bin	CIE x	CIE y
56D	0.3253	0.3266
	0.3323	0.3329
	0.3323	0.3251
	0.3256	0.3191
Reference Range: 5500~5850K		

Bin	CIE x	CIE y
53A	0.3325	0.3579
	0.3412	0.3652
	0.3406	0.3562
	0.3325	0.3493
Reference Range: 5180~5500K		

Bin	CIE x	CIE y
53B	0.3325	0.3493
	0.3406	0.3562
	0.3401	0.3476
	0.3324	0.3410
Reference Range: 5180~5500K		

Bin	CIE x	CIE y
53C	0.3324	0.3410
	0.3401	0.3476
	0.3396	0.3392
	0.3323	0.3329
Reference Range: 5180~5500K		

Bin	CIE x	CIE y
53D	0.3323	0.3329
	0.3396	0.3392
	0.3392	0.3310
	0.3323	0.3251
Reference Range: 5180~5500K		

Bin	CIE x	CIE y
50A	0.3406	0.3562
	0.3412	0.3652
	0.3486	0.3710
	0.3480	0.3620
Reference Range: 4910~5190K		

Bin	CIE x	CIE y
50B	0.3401	0.3476
	0.3406	0.3562
	0.3480	0.3620
	0.3474	0.3530
Reference Range: 4920~5190K		

Bin	CIE x	CIE y
50C	0.3396	0.3392
	0.3401	0.3476
	0.3474	0.3530
	0.3467	0.3445
Reference Range: 4910~5190K		

Bin	CIE x	CIE y
50D	0.3392	0.3310
	0.3396	0.3392
	0.3467	0.3445
	0.3461	0.3358
Reference Range: 4910~5190K		

White Color Bin Coordinates

Bin	CIE x	CIE y
47A	0.3486	0.3690
	0.3480	0.3620
	0.3584	0.3701
	0.3595	0.3770
Reference Range: 4610~4920K		

Bin	CIE x	CIE y
47B	0.3475	0.3550
	0.3480	0.3620
	0.3584	0.3701
	0.3573	0.3632
Reference Range: 4610~4920K		

Bin	CIE x	CIE y
47C	0.3470	0.3485
	0.3475	0.3550
	0.3573	0.3632
	0.3562	0.3562
Reference Range: 4610~4920K		

Bin	CIE x	CIE y
47D	0.3465	0.3410
	0.3470	0.3485
	0.3562	0.3562
	0.3551	0.3493
Reference Range: 4610~4920K		

Forward Voltage Bins

Bin code	Min Forward Voltage [V]	Max Forward Voltage [V]
2022	2.00	2.25
2225	2.25	2.50
2527	2.50	2.75
2730	2.75	3.00
3032	3.00	3.25
3235	3.25	3.50
3537	3.50	3.75
3740	3.75	4.00
4042	4.00	4.25
4245	4.25	4.50
4547	4.50	4.75

Notes:

1. Forward voltage measurement tolerance: $\pm 0.05V$.
2. Forward voltage bins are defined at $I_F = 150mA$ operation.

5. Part Number

A09K-C71501H-AM

Part number is designated with below details.

A09K = Product family name.

C = Color ^[1]

7 = CRI (0=N/A; >70%=7; >80%=8; >90%=9)

150 = Test current [mA]

1 = Lead Frame Type

H = Chip Code

AM = Automotive application

Note

[1] Color :

Symbol	Description
C	Cool White
N	Neutral White
W	Warm White
PA	Phosphor Converted Amber
PR	Phosphor Converted Red
UB	Blue
IB	Ice Blue
SB	Sky Blue
UP	Purple
UG	Green
UY	Yellow
UYG	Brilliant Yellow Green
UPG	Pale Green
UA	Amber
UR	Red
SR	Super Red
RGB	RGB-Color
PYG	Phosphor Converted Yellow Green

6. Ordering Information

A09K-C71501H-**ABCDEFGHIJKLMNO-PQ-AM**

Part Number of the A09K	Order Code
A09K-C71501H-AM	A09K-C71501H-ABCDEFGHIJKLMNO-PQ-AM

Order code contains information with below details :

ABCDEF = min/max wavelength or CCT

GHJK = min./max. luminous flux in [lm] or luminous intensity in [mcd]

LMNO = min./max. forward voltage

PQ = internal code

AM = Automotive Application

7. Mechanical Dimension

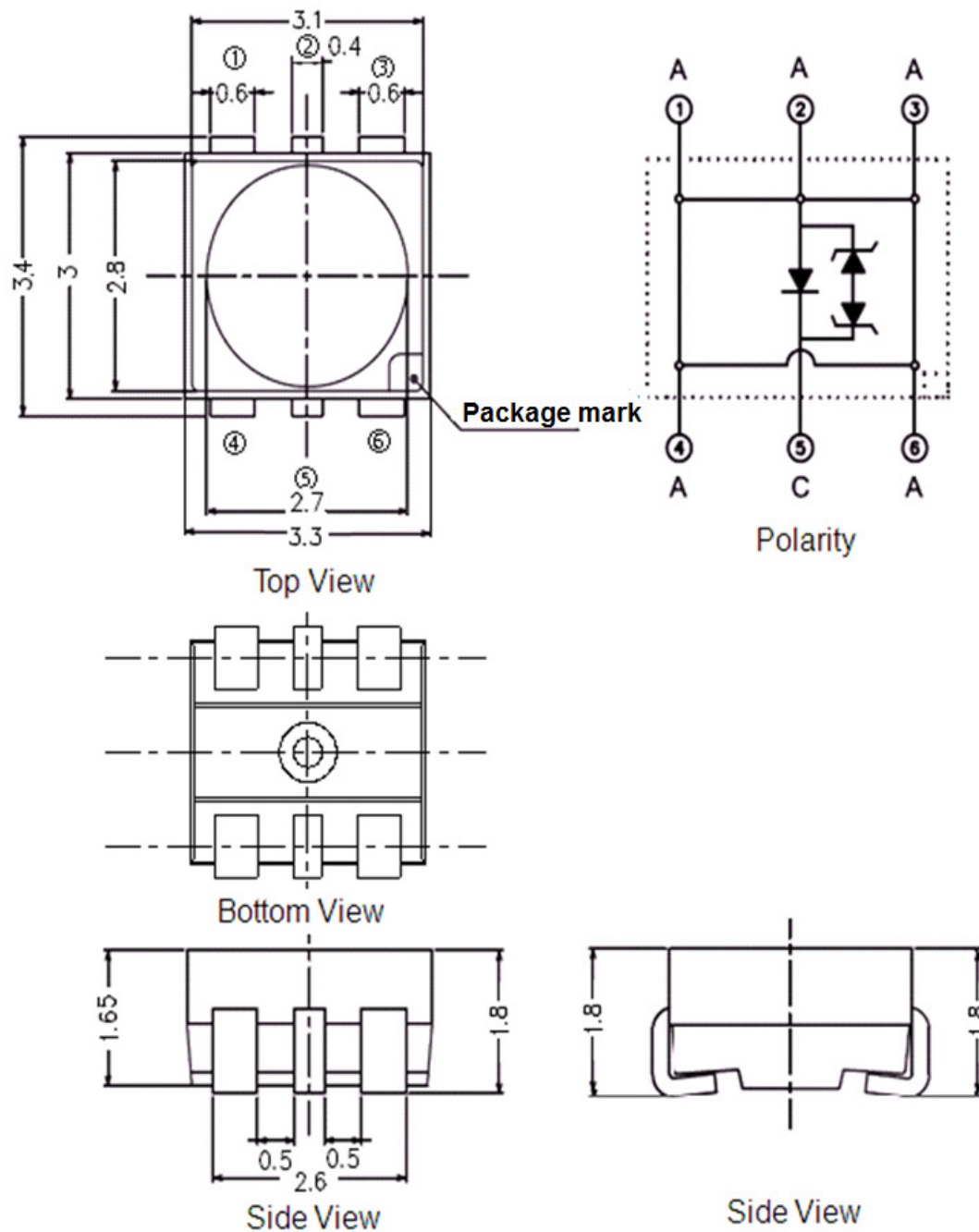

Notes:

1. Dimensions are in millimeters.
2. Tolerances unless mentioned are ± 0.1 mm.

8. Recommended Soldering Pad

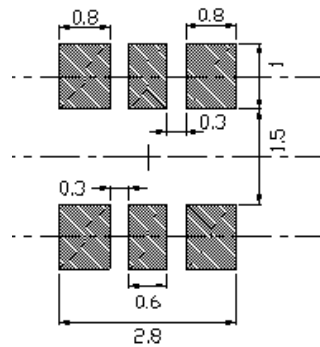

9. Reflow Soldering Profile

Soldering Condition (Reference: IPC/JEDEC J-STD-020D)

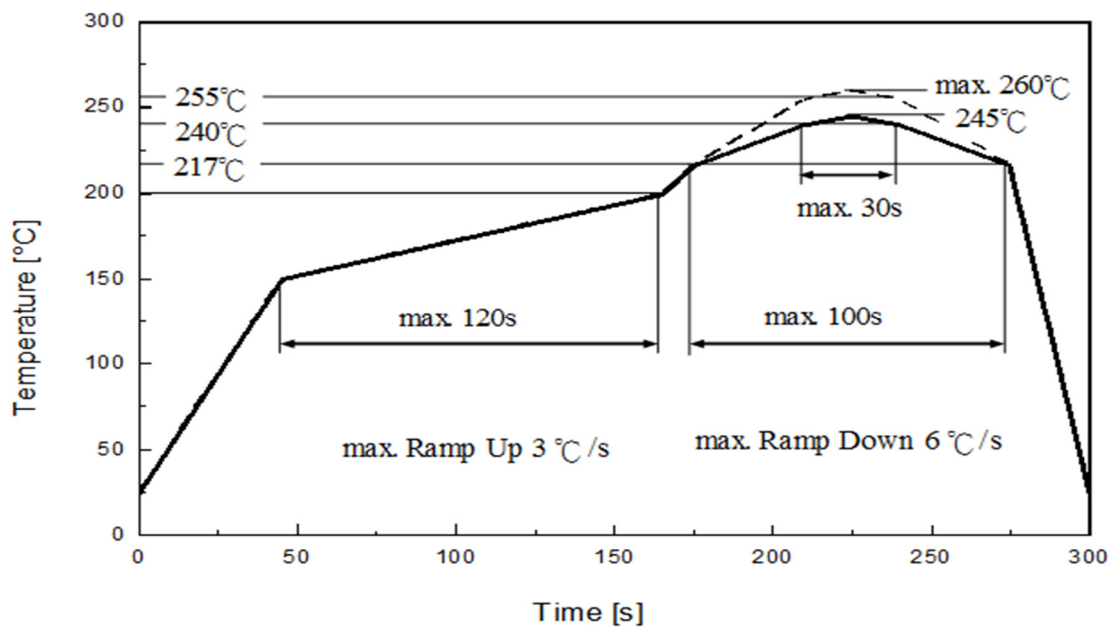

Profile Feature	Pb-Free Assembly	Unit
	Recommendation	
Ramp-up rate to preheat 25 °C to 150 °C	3	°C /sec
Time of soaking zone 150 °C to 200 °C	120	sec
Ramp-up rate to peak	3	°C /sec
Liquidus temperature	217	°C
Time above liquidus temperature	100	sec
Peak temperature (max.)	260	°C
Time within 5 °C of the specified peak temperature	30	sec
Ramp-down Rate (max.)	6	°C /sec

10. Packaging Information

• Product Labeling



- CPN : Customer's Product Number
- P/N : Everlight Part Number
- QTY : Packing Quantity
- CAT : Luminous Flux (Brightness) Bin
- HUE : Color Bin
- REF : Forward Voltage Bin
- LOT No : Lot Number

• Packing: Loaded Quantity 1000 pcs Per Reel

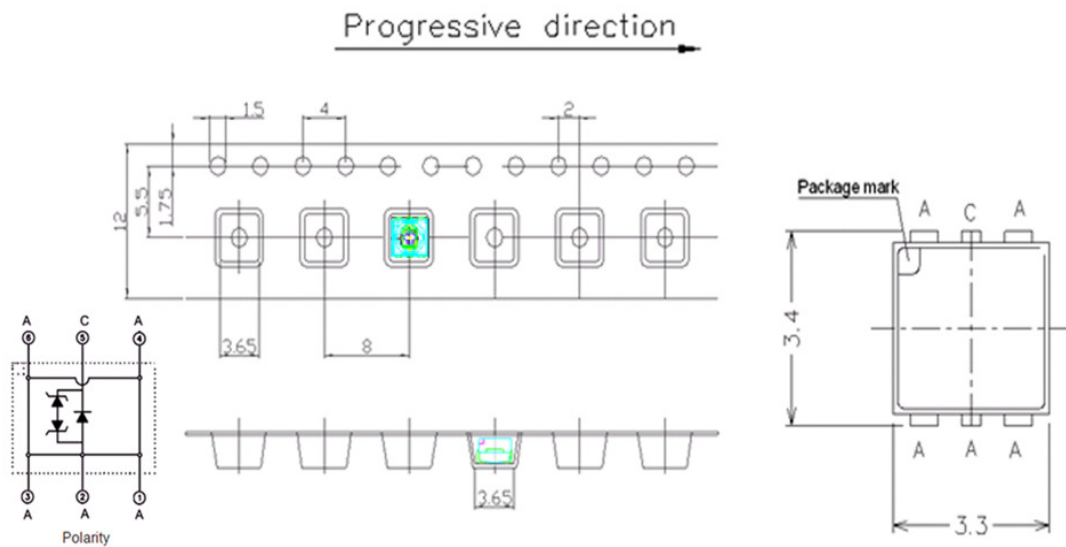

Notes:

1. Dimensions are in millimeters.

● **Reel Dimensions**

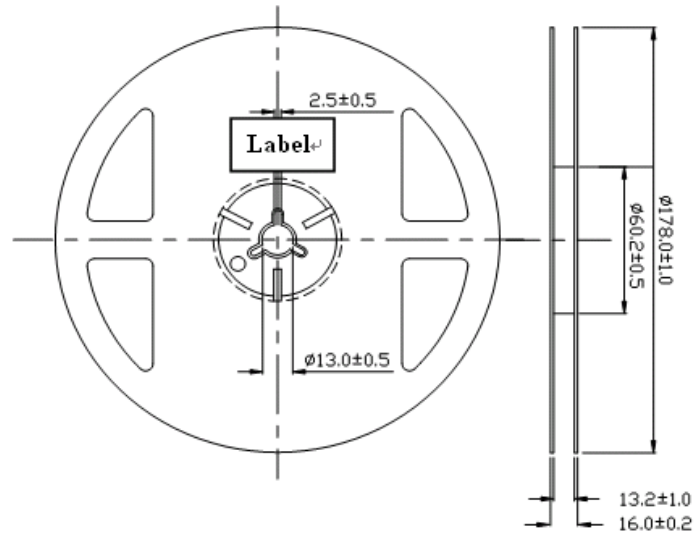

Notes:

1. Dimensions are in millimeters.

● **Moisture Resistant Packing Process**

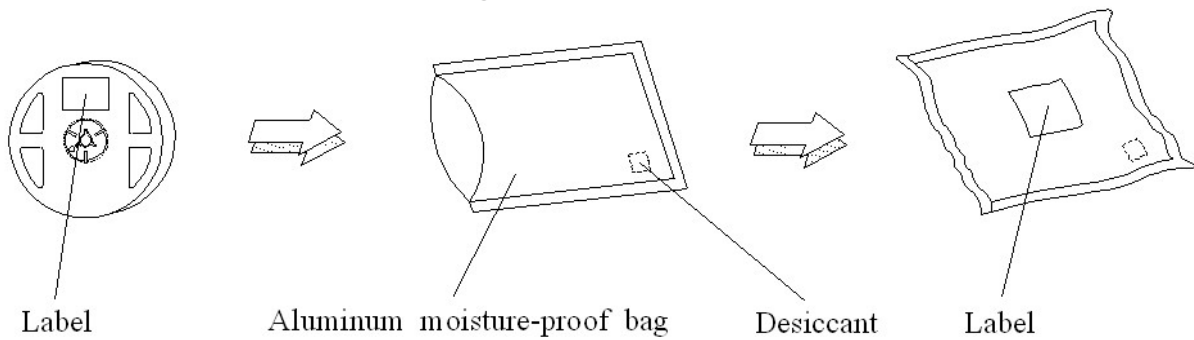

11. Precaution for Use

1. Over-current-proof

Customer must apply resistors for protection; otherwise slight voltage shift will cause big current change (burn out will happen).

2. Assemblies

Do not stack assemblies containing LEDs to prevent damage to the optical surface of LEDs. Forces applied to the optical surface may result in the surface being damaged.

3. Soldering Condition

3.1 When soldering, do not put stress on the LEDs during heating.

3.2 After soldering, do not warp the circuit board.

4. Soldering Iron

Each terminal is to go to the tip of soldering iron temperature less than 350°C for 3 seconds within once in less than the soldering iron capacity 25W. Leave two seconds and more intervals, and do soldering of each terminal. Be careful because the damage of the product is often started at the time of the hand solder.

5. Repairing

Repair should not be done after the LEDs have been soldered. When repairing is unavoidable, a double-head soldering iron should be used (as below figure). It should be confirmed beforehand whether the characteristics of the LEDs will or will not be damaged by repairing.

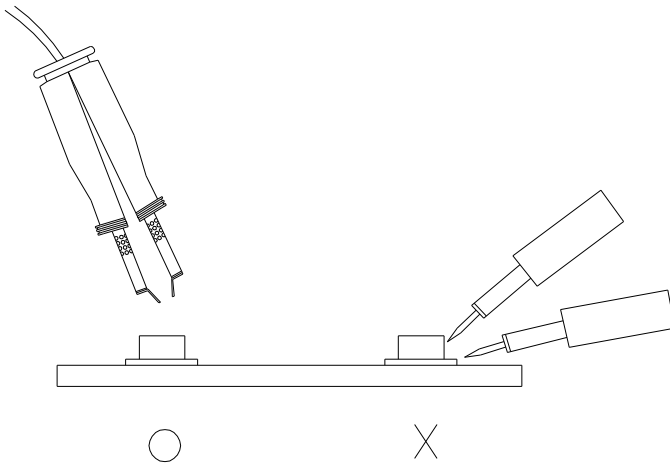

单击下面可查看定价，库存，交付和生命周期等信息

[>>Everlight \(亿光\)](#)