

Technical Data Sheet

0805 Package Chip LED (1.1mm Height)

17-21/R7C-AN2Q1B/3T

Features

- Package in 8mm tape on 7" diameter reel.
- Compatible with automatic placement equipment.
- Compatible with infrared and vapor phase reflow solder process.
- Mono-color type.
- Pb-free
- RoHS refer to SMD B type SGS report

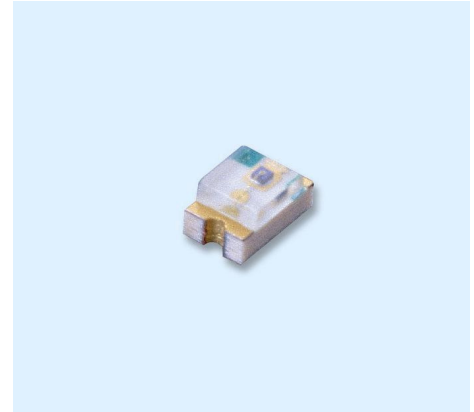

Descriptions

- The 17-21 SMD Taping is much smaller than lead frame type components, thus enable smaller board size, higher packing density, reduced storage space and finally smaller equipment to be obtained.
- Besides, lightweight makes them ideal for miniature applications, etc.

Applications

- Automotive: backlighting in dashboard and switch.
- Telecommunication: indicator and backlighting in telephone and fax.
- Flat backlight for LCD, switch and symbol.
- General use.

Device Selection Guide

PART No.	Chip		Resin Color
	Material	Emitted Color	
17-21/R7C-AN2Q1B/3T	AlGaInP	Dark Red	Water Clear

Package Outline Dimensions

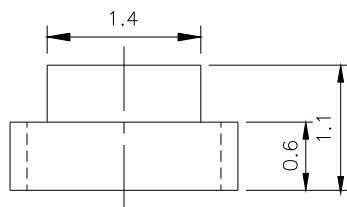
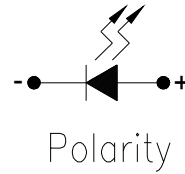
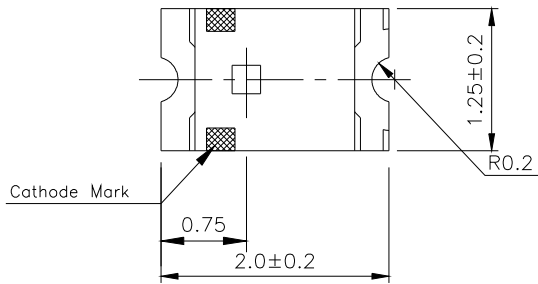

For reflow soldering (propose)

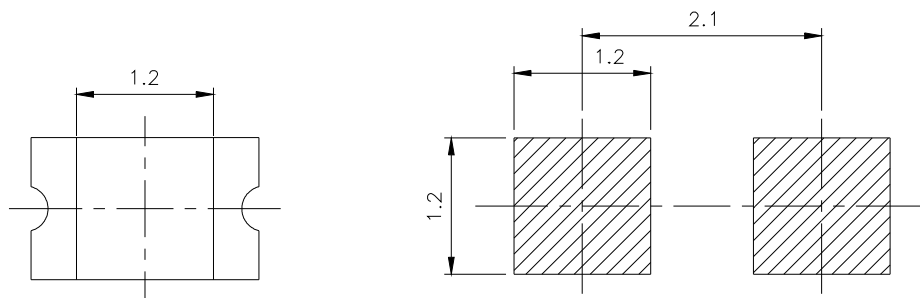

Note: The tolerances unless mentioned are ± 0.1 , unit = mm.

17-21/R7C-AN2Q1B/3T
Absolute Maximum Ratings (Ta=25°C)

Parameter	Symbol	Rating	Unit
Reverse Voltage	V _R	5	V
Forward Current	I _F	25	mA
Peak Forward Current (Duty 1/10 @1KHz)	I _{FP}	60	mA
Power Dissipation	P _d	60	mW
Electrostatic Discharge(HBM)	ESD	2000	V
Operating Temperature	T _{opr}	-40 ~ +85	°C
Storage Temperature	T _{stg}	-40~ +90	°C
Soldering Temperature	T _{sol}	Reflow Soldering : 260 °C for 10 sec. Hand Soldering : 350 °C for 3 sec.	

Electro-Optical Characteristics (Ta=25°C)

Parameter	Symbol	Min.	Typ.	Max.	Unit	Condition
Luminous Intensity	I _v	36.0	-----	90.0	mcd	I _F =20 mA
Viewing Angle	2θ 1/2	-----	140	-----	deg	
Peak Wavelength	λ _p	-----	639	-----	nm	
Dominant Wavelength	λ _d	625.5	-----	637.5	nm	
Spectrum Radiation Bandwidth	Δλ	-----	20	-----	nm	
Forward Voltage	V _F	1.75	-----	2.35	V	
Reverse Current	I _R	-----	-----	10	μA	V _R =5V

Notes:

- 1.Tolerance of Luminous Intensity ±11%**
- 2.Tolerance of Dominant Wavelength ±1nm**
- 3.Tolerance of Forward Voltage ±0.1V**

Bin Range Of Dom. Wavelength

Group	Bin	Min	Max	Unit	Condition
A	E6	625.5	629.5	nm	IF=20mA
	E7	629.5	633.5		
	E8	633.5	637.5		

Bin Range Of Luminous Intensity

Bin	Min	Max	Unit	Condition
N2	36.0	45.0	mcd	IF=20mA
P1	45.0	57.0		
P2	57.0	72.0		
Q1	72.0	90.0		

Bin Range Of Forward Voltage

Groups	Bin	Min	Max	Unit	Condition
B	0	1.75	1.95	V	IF=20mA
	1	1.95	2.15		
	2	2.15	2.35		

Notes:

- 1.Tolerance of Luminous Intensity $\pm 11\%$**
- 2.Tolerance of Dominant Wavelength $\pm 1\text{nm}$**
- 3.Tolerance of Forward Voltage $\pm 0.1\text{V}$**

Typical Electro-Optical Characteristics Curves

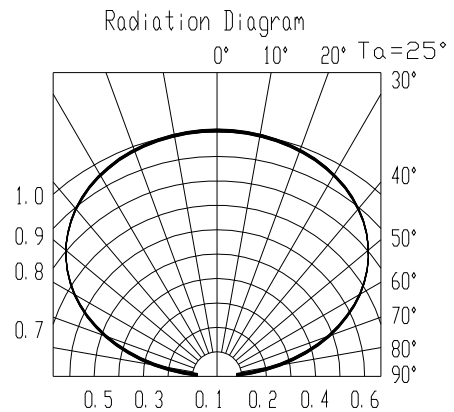
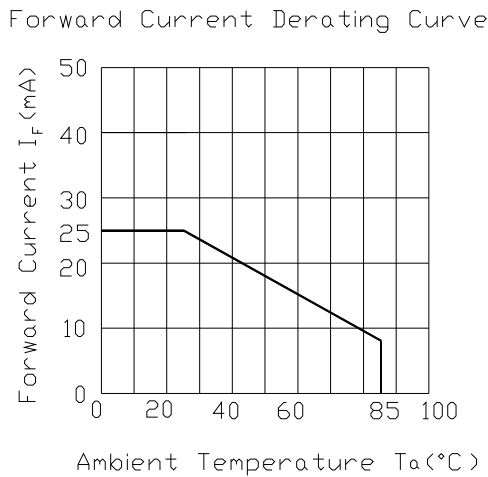
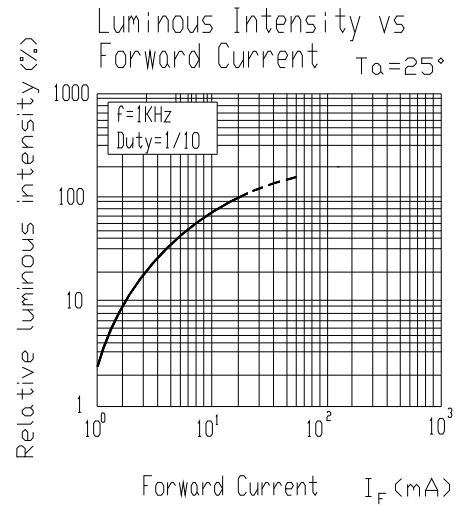
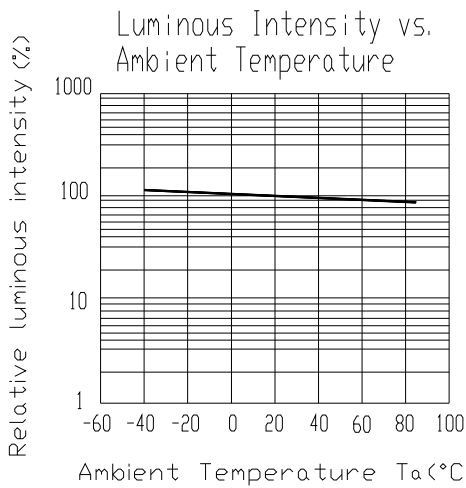
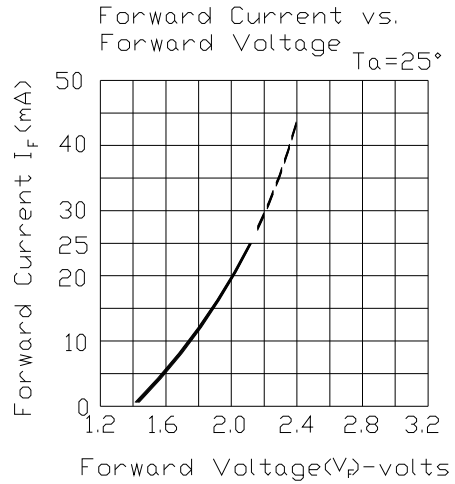
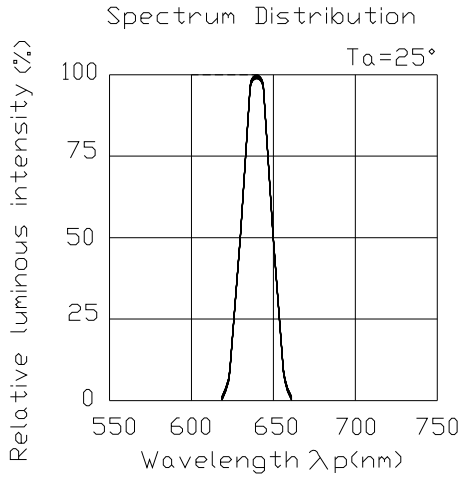

Label explanation

CAT: Luminous Intensity Rank

HUE: Dom. Wavelength Rank

REF: Forward Voltage Rank

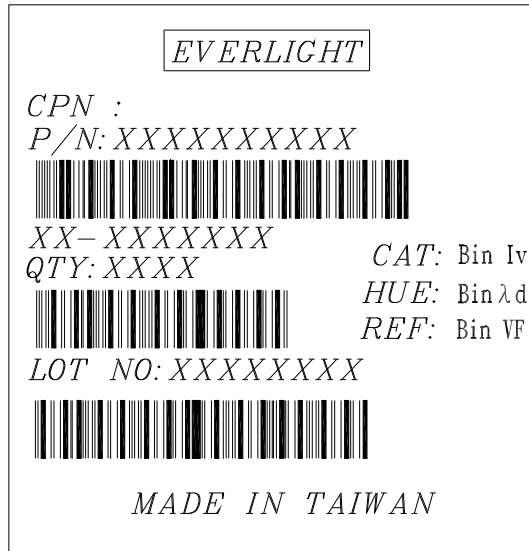

Reel Dimensions

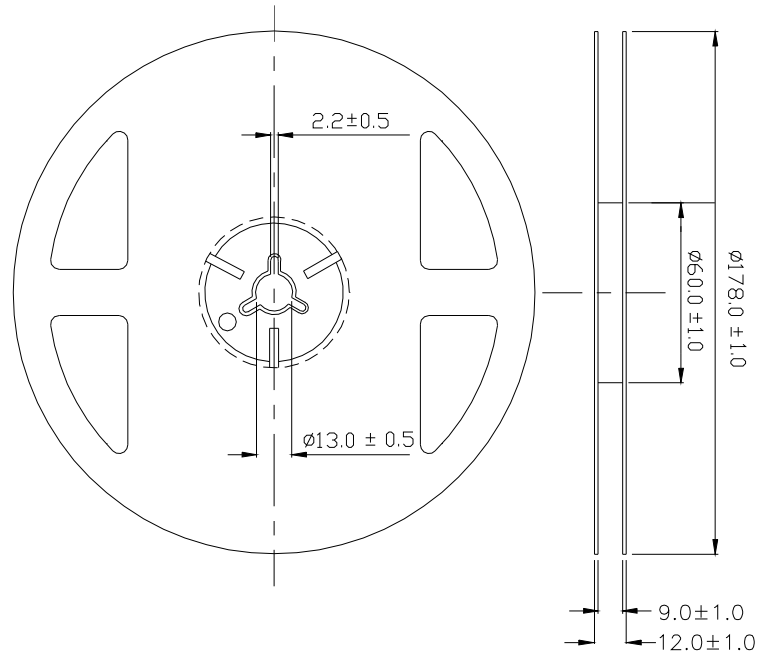

Note: The tolerances unless mentioned are ±0.1, unit = mm.

Reliability Test Items And Conditions

The reliability of products shall be satisfied with items listed below.

Confidence level : 90 %

LTPD : 10 %

No.	Items	Test Condition	Test Hours/Cycles	Sample Size	Ac/Re
1	Reflow Soldering	Temp. : 260°C ±5°C Min.5 sec.	6 min.	22 Pcs.	0/1
2	Temperature Cycle	H : +100°C 15min. ∫ 5 min. L : -40°C 15min.	300 Cycles	22 Pcs.	0/1
3	Thermal Shock	H : +100°C 5min. ∫ 10 sec. L : -10°C 5min.	300 Cycles	22 Pcs.	0/1
4	High Temperature Storage	Temp. : 100°C	1000 Hrs.	22 Pcs.	0/1
5	Low Temperature Storage	Temp. : -40°C	1000 Hrs.	22 Pcs.	0/1
6	DC Operating Life	I _F = 20 mA	1000 Hrs.	22 Pcs.	0/1
7	High Temperature / High Humidity	85°C / 85% R.H.	1000 Hrs.	22 Pcs.	0/1

Precautions For Use

1. Over-current-proof

Customer must apply resistors for protection , otherwise slight voltage shift will cause big current change (Burn out will happen).

2. Storage

- 2.1 Do not open moisture proof bag before the products are ready to use.
- 2.2 Before opening the package, the LEDs should be kept at 30°C or less and 90%RH or less.
- 2.3 The LEDs should be used within a year.
- 2.4 After opening the package, the LEDs should be kept at 30°C or less and 70%RH or less.
- 2.5 The LEDs should be used within 168 hours (7 days) after opening the package.
- 2.6 If the moisture absorbent material (silica gel) has faded away or the LEDs have exceeded the storage time, baking treatment should be performed using the following conditions.
Baking treatment : 60±5°C for 24 hours.

3. Soldering Condition

3.1 Pb-free solder temperature profile

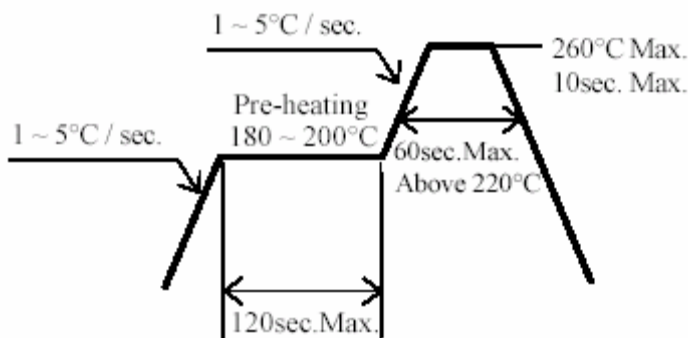

- 3.2 Reflow soldering should not be done more than two times.
- 3.3 When soldering, do not put stress on the LEDs during heating.
- 3.4 After soldering, do not warp the circuit board.

4. Soldering Iron

Each terminal is to go to the tip of soldering iron temperature less than 280°C for 3 seconds within once in less than the soldering iron capacity 25W. Leave two seconds and more intervals, and do soldering of each terminal. Be careful because the damage of the product is often started at the time of the hand solder.

5.Repairing

Repair should not be done after the LEDs have been soldered. When repairing is unavoidable, a double-head soldering iron should be used (as below figure). It should be confirmed beforehand whether the characteristics of the LEDs will or will not be damaged by repairing.

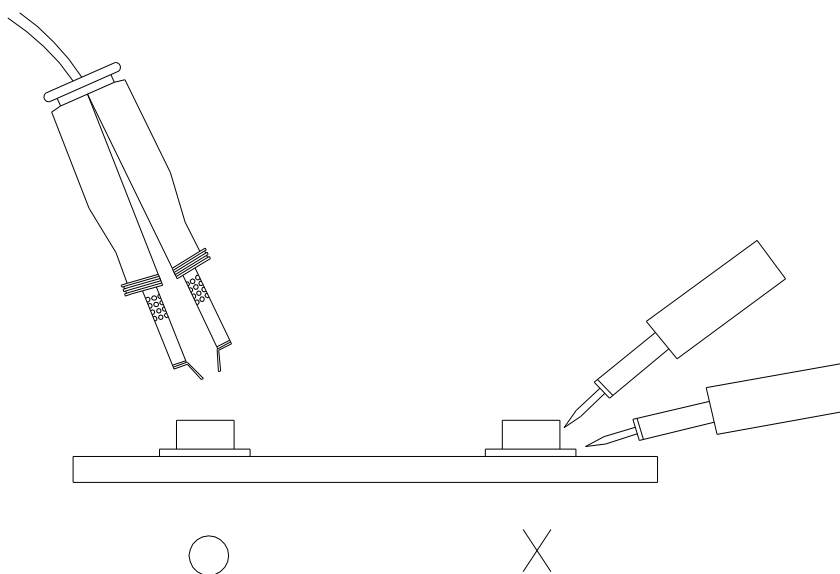

EVERLIGHT ELECTRONICS CO., LTD.
Office: No 25, Lane 76, Sec 3, Chung Yang Rd,
Tucheng, Taipei 236, Taiwan, R.O.C

Tel: 886-2-2267-2000, 2267-9936
Fax: 886-2267-6244, 2267-6189, 2267-6306
<http://www.everlight.com>

单击下面可查看定价，库存，交付和生命周期等信息

[>>Everlight \(亿光\)](#)