

### EL 3030E

### XI3030-PA3501H-AM



#### Features

- Package: SMD EMC package
- Typical Color : CIE x 0.575 CIE y 0.415 phosphor converted amber
- Typical Luminous Flux: 65 lm @ 350mA
- Viewing angle: 120 °
- ESD : up to 8KV
- MSL : 2
- Qualifications: According to AEC-Q102
- Compliance with RoHS and REACH
- Sulfur robustness
- Compliance Halogen Free. (Br <900 ppm ,Cl <900 ppm , Br+Cl < 1500 ppm).

#### Applications

- Automotive exterior lighting
- Turning Light

# Contents

1. Characteristics.....	3
2. Absolute Maximum Ratings.....	4
3. Characteristics Graph.....	5
4. Binning Information.....	10
5. Part Number.....	13
6. Ordering Information.....	14
7. Mechanical Dimension.....	15
8. Recommended Soldering Pad.....	16
9. Reflow Soldering Profile.....	16
10. Packaging Information.....	17
11. Precaution for Use.....	19

## 1. Characteristics

Parameter	Symbol	Min.	Typ.	Max.	Unit	Condition	
Forward Current	$I_F$	50	350	500	mA	---	
Luminous Flux <sup>[1][2]</sup>	$I_v$	52	65	90	lm	$I_F=350\text{mA}$	
Forward Voltage <sup>[3][4]</sup>	$V_F$	2.5	3.1	3.5	V	$I_F=350\text{mA}$	
Viewing Angle	$\phi$	---	120	---	deg	$I_F=350\text{mA}$	
Chromaticity Coordinates <sup>[5]</sup>	C x		0.575		---	$I_F=350\text{mA}$	
	C y		0.415		---	$I_F=350\text{mA}$	
Thermal Resistance (Junction to Solder)	Real	$R_{th JS real}$	---	40	48	K/W	$I_F=350\text{mA}$
	Electrical	$R_{th JS el}$	---	33	40		

### Notes:

1. Luminous Flux measurement tolerance:  $\pm 8\%$ .
2. The data of Luminous Flux measured at thermal pad=25°C
3. Forward voltage measurement tolerance:  $\pm 0.05\text{V}$
4. The  $V_F$  range shown in the table above indicates 99% output.
5. Tolerance of Chromaticity Coordinates x,y :  $\pm 0.005$ .

## 2. Absolute Maximum Ratings

Parameter	Symbol	Ratings	Unit
Power Dissipation	$P_d$	1750	mW
DC Forward Current	$I_F$	500	mA
Surge current ( $t \leq 10 \mu s$ ; $D=0.005$ ; $T_s=25 \text{ }^\circ\text{C}$ )	$I_{FM}$	2300	mA
Reverse Voltage	$V_R$	Not designed for reverse operation	V
Junction Temperature	$T_J$	150	$^\circ\text{C}$
Operating Temperature	$T_{opr}$	-40 ~ +125	$^\circ\text{C}$
Storage Temperature	$T_{stg}$	-40 ~ +125	$^\circ\text{C}$
ESD Sensitivity ( $R=1.5k\Omega$ , $C=100pF$ Condition)	$ESD_{HBM}$	8	kV
Soldering Temperature	Reflow	260 $^\circ\text{C}$ for 30 sec	$^\circ\text{C}$

### 3. Characteristics Graph

#### Wavelength Characteristics Relative Spectral Distribution

@ Ts = 25°C , If=350mA

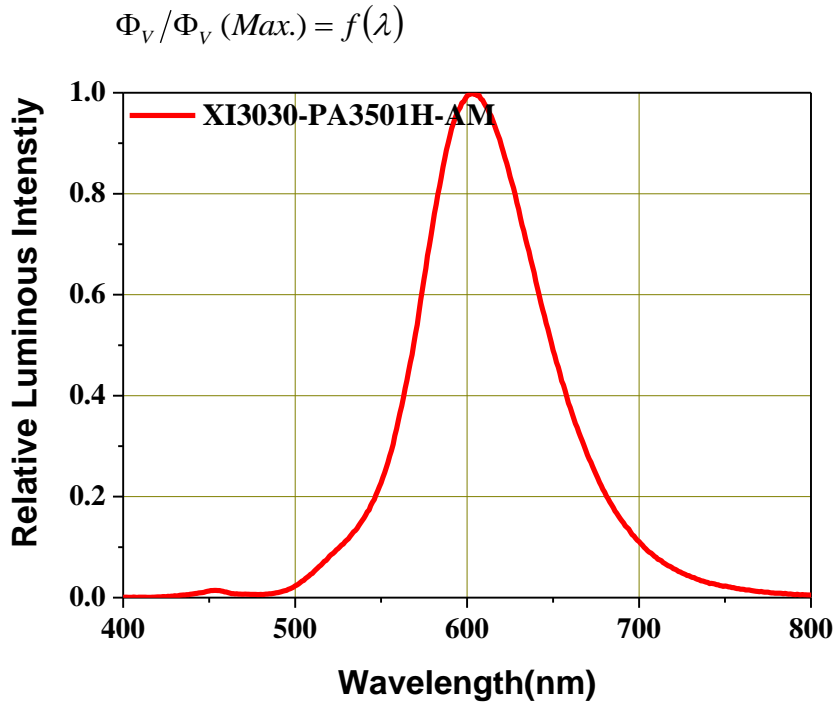

#### Typical Diagram Characteristics of Radiation

$\Phi_v / \Phi_v (0^\circ) = f(\varphi)$

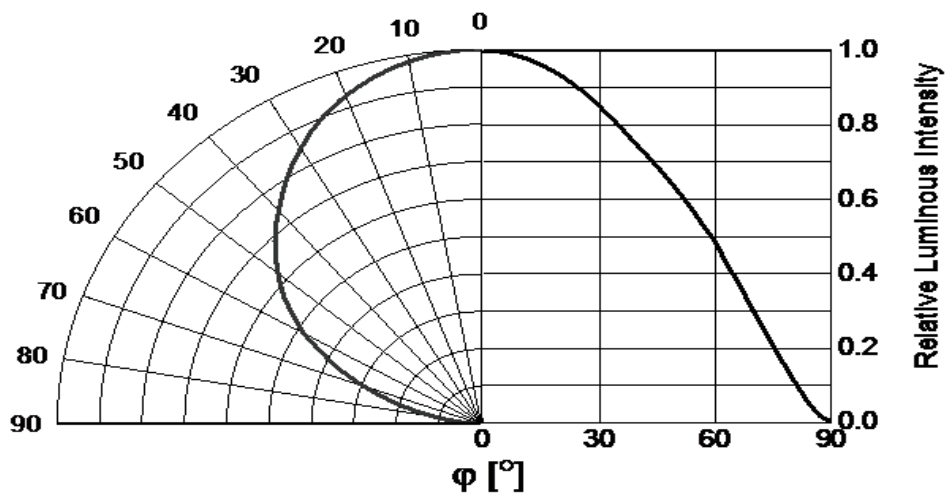

**Notes:**

1.  $\varphi$  is the off axis angle from lamp centerline where the luminous intensity is 1/2 of the peak value.
2. View angle tolerance is  $\pm 5$

**Forward Current vs. Forward Voltage**

@ Ts = 25°C

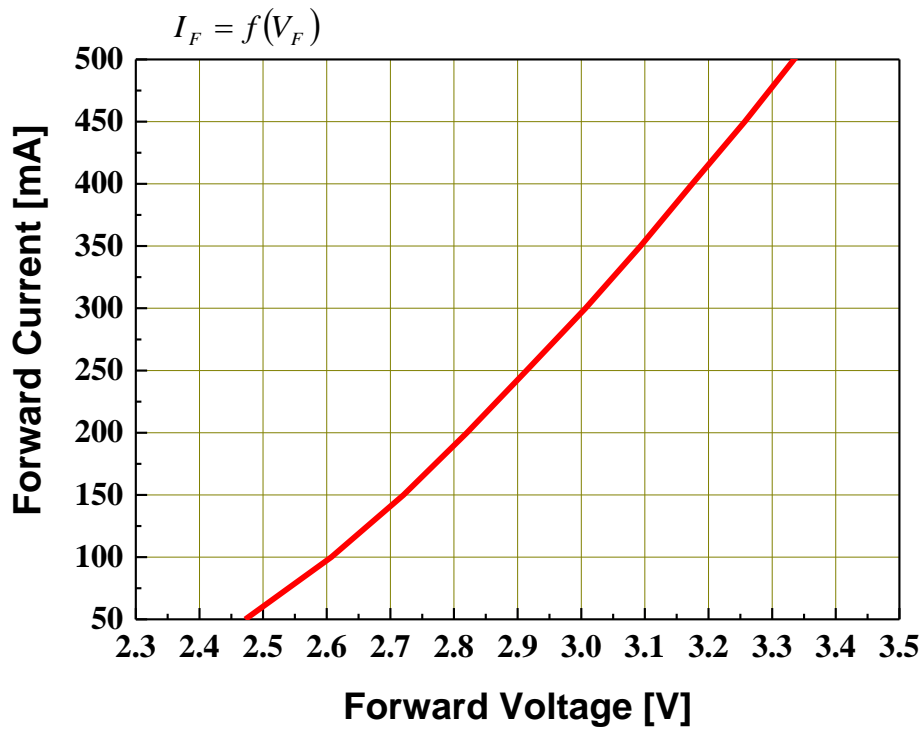

**Relative Luminous Flux vs. Forward Current**

@ Ts = 25°C

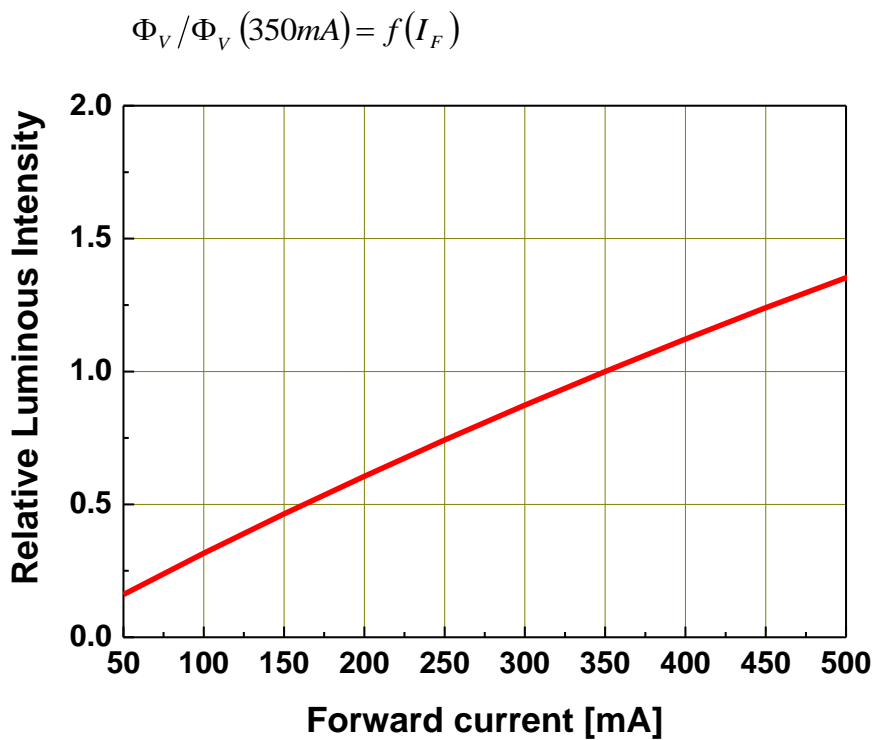

**Chromaticity Coordinates Shift vs. Forward Current**  
@ Ts = 25°C

$$\Delta CIE\ x, \Delta CIE\ y = f(I_F)$$

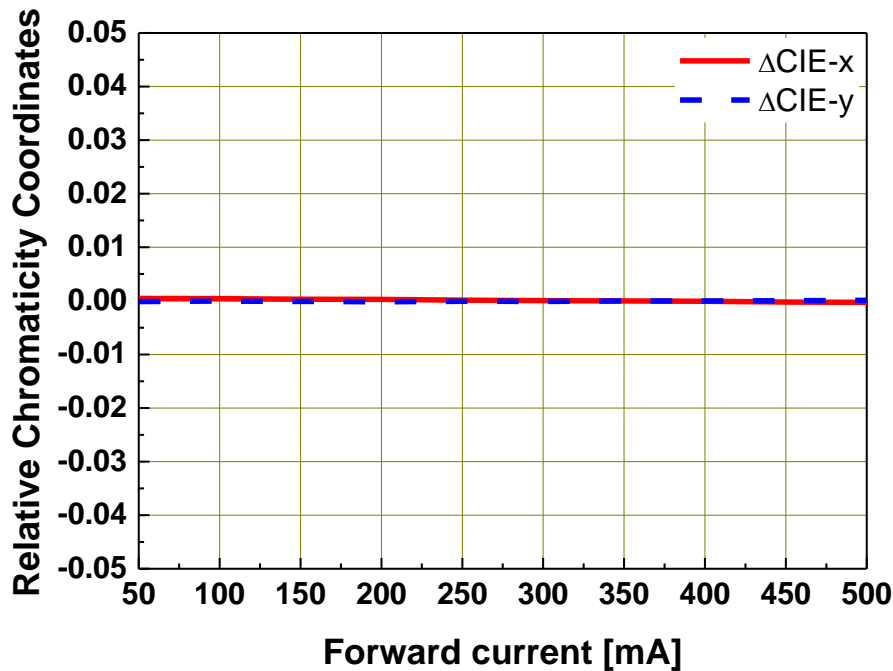

**Relative Forward Voltage vs. Junction Temperature**  
@ IF=350mA

$$\Delta V_F = V_F - V_F(25^\circ C) = f(T_j)$$

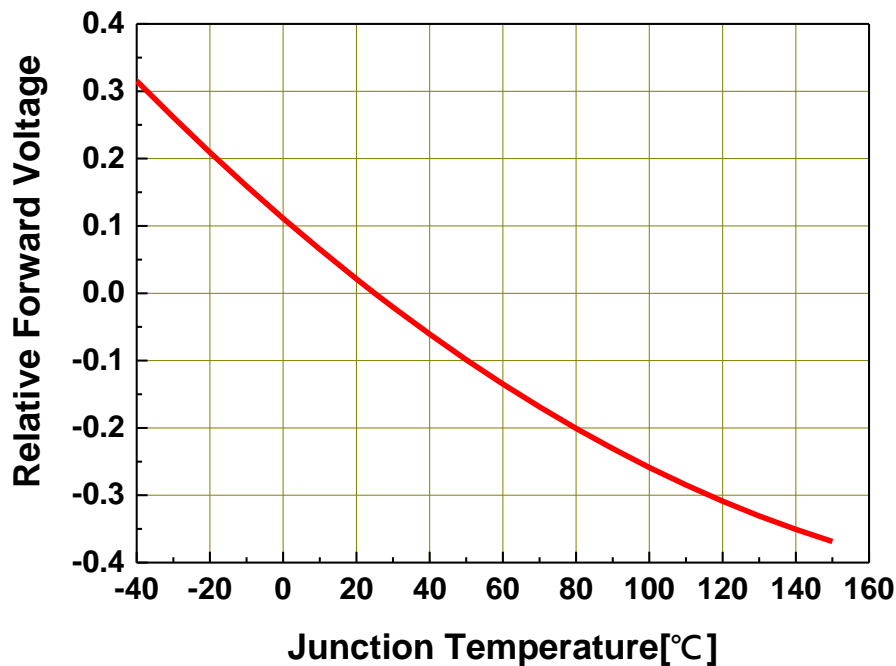

**Relative Luminous Flux vs. Junction Temperature**

@  $I_F=350mA$

$$\Phi_v / \Phi_v(25^\circ C) = f(T_j)$$

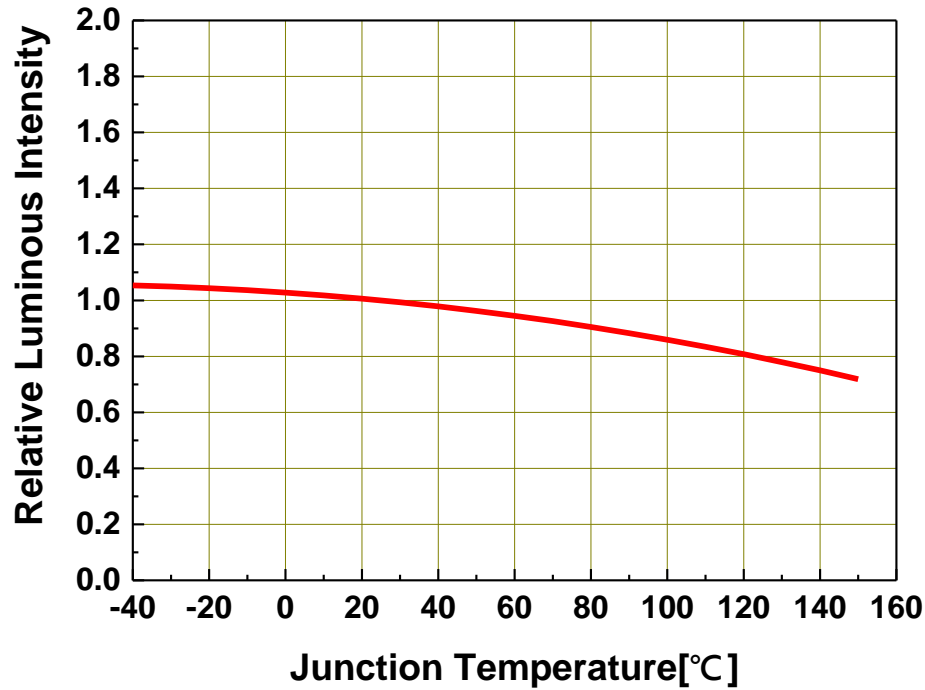

**Chromaticity Coordinates Shift vs. Junction Temperature**

@  $I_F=350mA$

$$\Delta CIE x, \Delta CIE y = f(T_j)$$

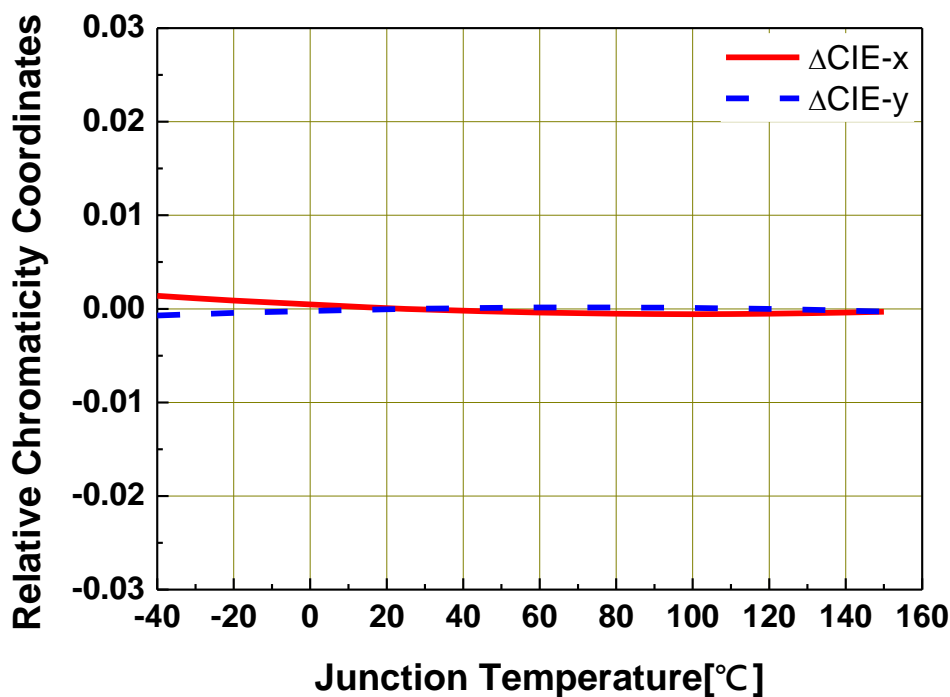



### Forward Current Derating Curve @ Soldering Temperature

$$I_F = f(T_s)$$

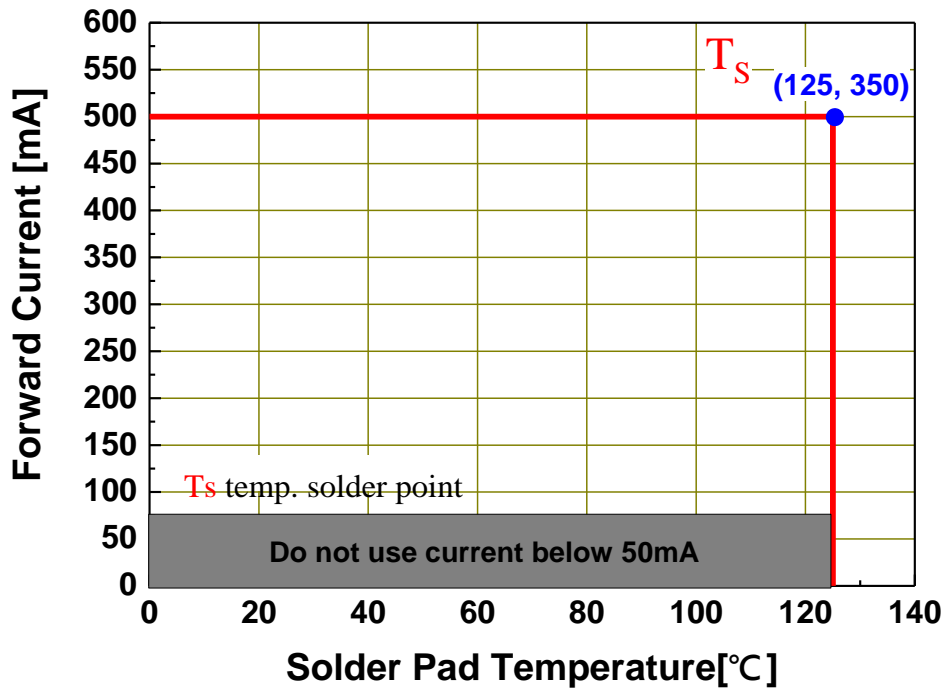

### Permissible Pulse Handling Capability

D=Duty cycle ,  $T_s = 25C$

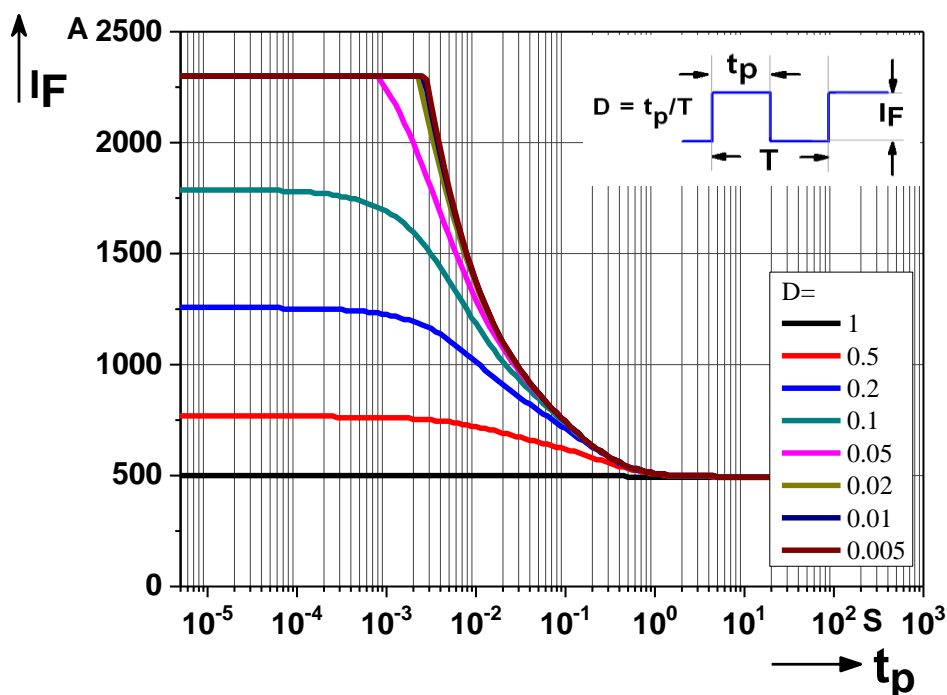

## 4. Binning Information

### Luminous Intensity Bins

Group	Bin	Minimum Photometric Flux (lm)	Maximum Photometric Flux (lm)
E	1	4	5
	2	5	6
	3	6	8
	4	8	10
	5	10	13
	6	13	17
	7	17	20
	8	20	23
	9	23	27
F	1	27	33
	2	33	39
	3	39	45
	4	45	52
	5	52	60
	6	60	70
	7	70	80
	8	80	90
	9	90	100

Group	Bin	Minimum Photometric Flux (lm)	Maximum Photometric Flux (lm)
J	1	100	110
	2	110	120
	3	120	130
	4	130	140
	5	140	150
	6	150	160
	7	160	180
	8	180	200
	9	200	225
K	1	225	250
	2	250	275
	3	275	300
	4	300	325
	5	325	350
	6	350	375
	7	375	400
	8	400	425
	9	425	450

**Notes:**

1. Luminous Intensity measurement tolerance:  $\pm 8\%$ .

**Product Binning Color Bin Structure  
 ECE Bin Structure**

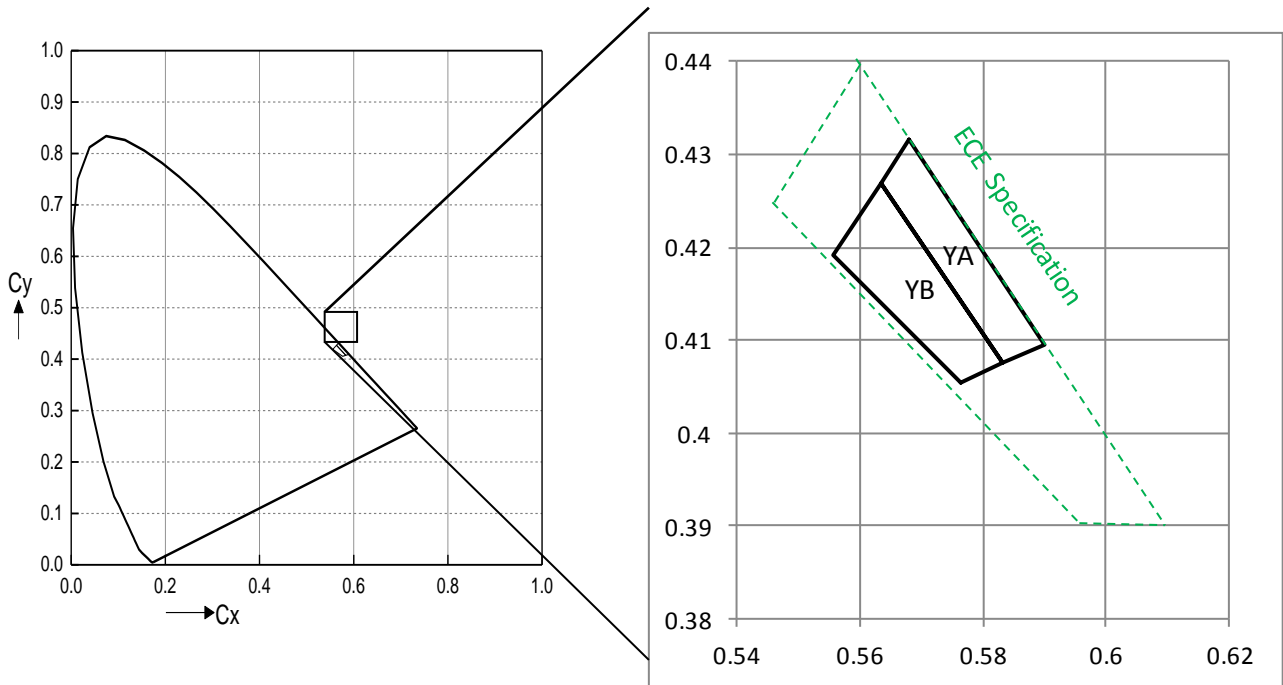

**ECE Phosphor Yellow Bin Coordinates**

Bin	CIE x	CIE y
YA	0.5680	0.4315
	0.5634	0.4269
	0.5833	0.4075
	0.5901	0.4094

Bin	CIE x	CIE y
YB	0.5763	0.4054
	0.5833	0.4075
	0.5634	0.4269
	0.5557	0.4192

**Notes:**

1. Color coordinates measurement allowance:  $\pm 0.005$

### Forward Voltage Bins

Bin	Minimum Forward Voltage [V]	Maximum Forward Voltage [V]
1012	1.00	1.25
1215	1.25	1.75
1517	1.50	1.75
1720	1.75	2.00
2022	2.00	2.25
2225	2.25	2.50
2527	2.50	2.75
2730	2.75	3.00
3032	3.00	3.25
3235	3.25	3.50
3537	3.50	3.75
3740	3.75	4.00
4042	4.00	4.25
4245	4.25	4.50
4547	4.50	4.75
4750	4.75	5.00
5052	5.00	5.25
5255	5.25	5.50
5557	5.50	5.75
5760	5.75	6.00
6062	6.00	6.25
6265	6.25	6.50
6567	6.50	6.75
6770	6.75	7.00

**Notes:**

1. Forward voltage measurement tolerance:  $\pm 0.05V$ .
2. Forward voltage bins are defined at  $I_F = 350mA$  operation.

## 5. Part Number

### XI3030-PA3501H-AM

Part number is designated with below details.

XI3030 = product family name.

PA = color [1]

350 = Test current [mA]

1 = Lead Frame Type ( 0=Ag ; 1=Au; 2=MLP)

H = Brightness Level (H=High ; M=Medium ; L=Low)

AM = Automotive Application

Note

[1] Color :

Symbol	Description
C	Cool White
N	Neutral White
W	Warm White
PA	Phosphor Converted Amber
PR	Phosphor Converted Red
UB	Blue
IB	Ice Blue
SB	Sky Blue
UP	Purple
UG	Green
UY	Yellow
US	Orange
UA	Amber
UR	Red
SR	Super Red
RGB	RGB – Color
RGBY	RGBY – Color

## 6. Ordering Information

Part Number of the EL 3030E	Order Code
XI3030-PA3501H-AM	XI3030-PA3501H-YAYBF5F82535-2T-AM

Order code contains information with below details :

ABCD = min/max wavelength or CCT

EFGH = min./max. luminous flux in [lm] or luminous intensity in [mcd]

IJKL = min./max. forward voltage

MO = internal code

## 7. Mechanical Dimension

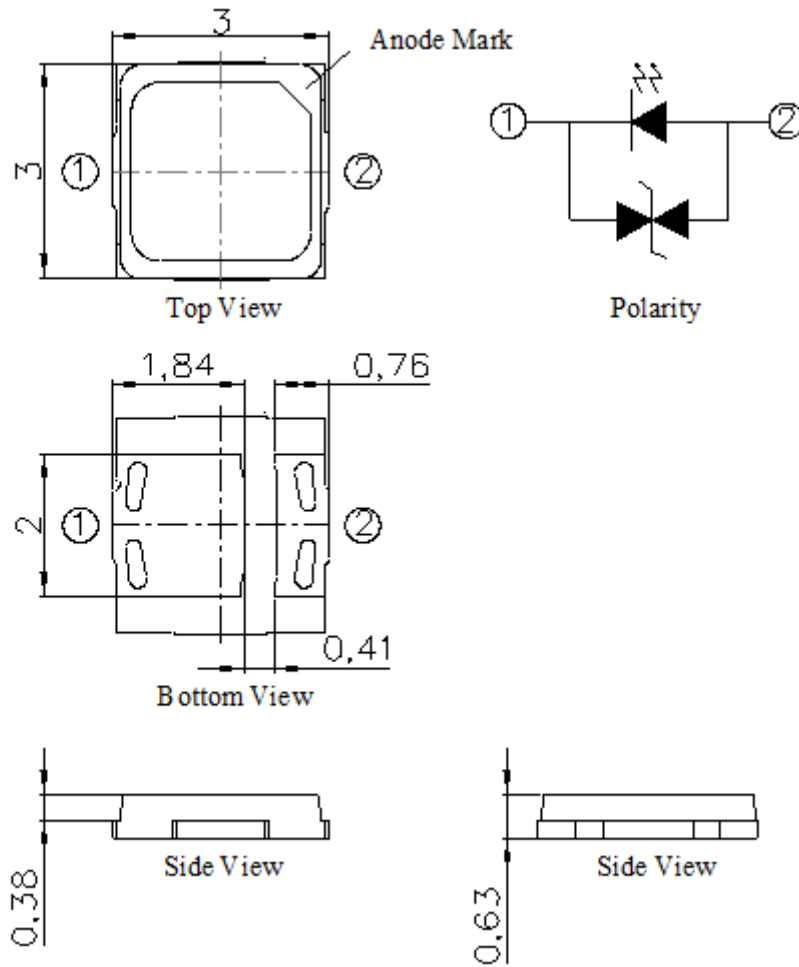

### Notes:

1. Dimensions are in millimeters.
2. Tolerances unless mentioned are  $\pm 0.1$ mm.

## 8.Recommended Soldering Pad

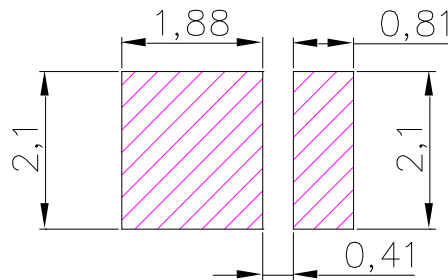

## 9.Reflow Soldering Profile

Soldering Condition (Reference: IPC/JEDEC J-STD-020D)

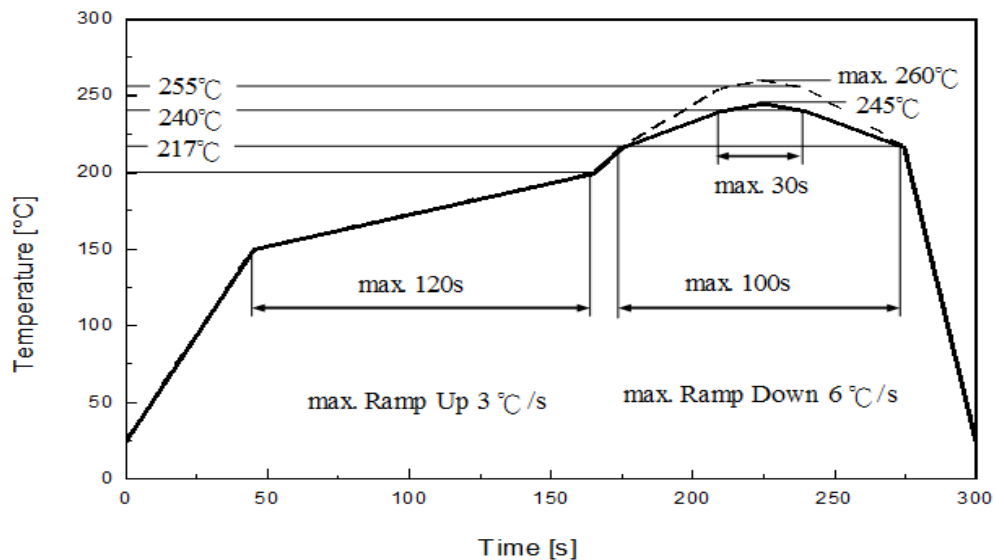

Profile Feature	Pb-Free Assembly	Unit Einheit
	Recommendation	
Ramp-up rate to preheat 25 °C to 150 °C	3	°C /sec
Time of soaking zone 150 °C to 200 °C	120	sec
Ramp-up rate to peak	3	°C /sec
Liquidus temperature	217	°C
Time above liquidus temperature	100	sec
Peak temperature (max.)	260	°C
Time within 5°C of the specified peak temperature	30	sec
Ramp-down Rate (max.)	6	°C /sec



## 10. Packaging Information

### ● Product Labeling



- CPN : Customer's Product Number
- P/N : Everlight Part Number
- QTY : Packing Quantity
- CAT : Luminous Flux (Brightness) Bin
- HUE : Color Bin
- REF : Forward Voltage Bin
- LOT No : Lot Number

### ● Packing: Loaded Quantity 2000 pcs Per Reel

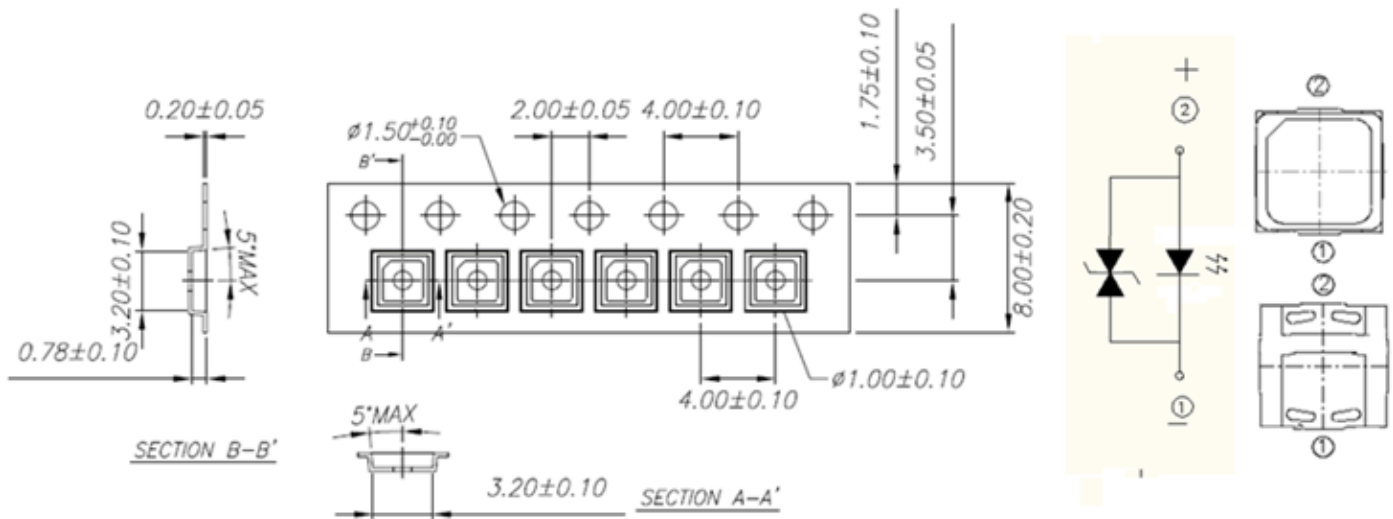

#### Notes:

1. Dimensions are in millimeters.

● **Reel Dimensions**

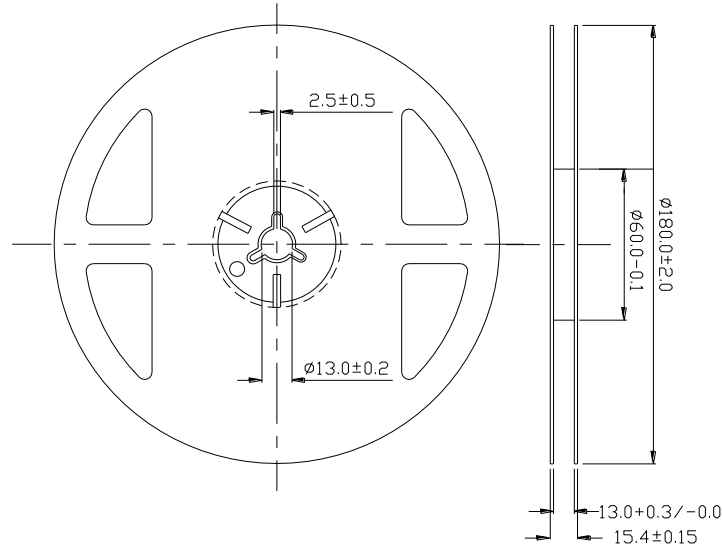

**Notes:**

1. Dimensions are in millimeters.

● **Moisture Resistant Packing Process**

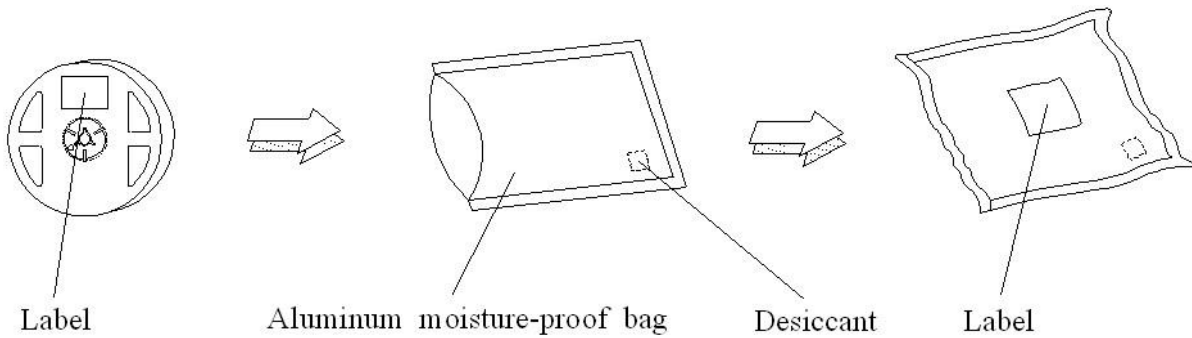

## 11. Precaution for Use

### 1. Over-current-proof

Customer must apply resistors for protection; otherwise slight voltage shift will cause big current change (burn out will happen).

### 2. Assemblies

Do not stack assemblies containing LEDs to prevent damage to the optical surface of LEDs. Forces applied to the optical surface may result in the surface being damaged.

### 3. Soldering Condition

3.1 When soldering, do not put stress on the LEDs during heating.

3.2 After soldering, do not warp the circuit board.

### 4. Soldering Iron

Each terminal is to go to the tip of soldering iron temperature less than 350°C for 3 seconds within once in less than the soldering iron capacity 25W. Leave two seconds and more intervals, and do soldering of each terminal. Be careful because the damage of the product is often started at the time of the hand solder.

### 5. Repairing

Repair should not be done after the LEDs have been soldered. When repairing is unavoidable, a double-head soldering iron should be used (as below figure). It should be confirmed beforehand whether the characteristics of the LEDs will or will not be damaged by repairing.

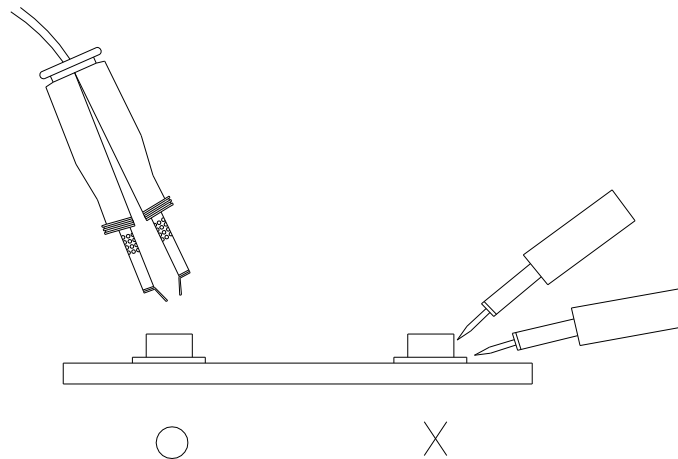

单击下面可查看定价，库存，交付和生命周期等信息

[>>Everlight \(亿光\)](#)