

## 4 PIN LONG CREEPAGE SOP PHOTOTRANSISTOR PHOTOCOUPLER EL101X-G Series

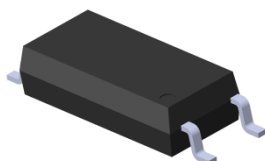

### Features:

- Free halogens compliant
- Current transfer ratio  
(CTR: 50~600% at  $I_F = 5\text{mA}$ ,  $V_{CE} = 5\text{V}$ )  
(CTR: 63~320% at  $I_F = 10\text{mA}$ ,  $V_{CE} = 5\text{V}$ )
- High isolation voltage between input and output ( $V_{iso} = 5000\text{ V rms}$ )
- Compact 4 Pin SOP with a 2.0 mm profile
- 8mm long creepage distance
- Pb free and RoHS compliant.
- UL approved (No. E214129)
- VDE approved (No. 40028391)
- SEMKO approved
- NEMKO approved
- DEMKO approved
- FIMKO approved

### Description

The EL101X-G series devices consist of an infrared emitting diode, optically coupled to a phototransistor detector. Compound use free halogens and  $\text{Sb}_2\text{O}_3$ . They are packaged in a 4-pin SOP package

### Applications

- Programmable controllers
- System appliances, measuring instruments
- Telecommunication equipments
- Home appliances, such as fan heaters, etc.
- Signal transmission between circuits of different potentials and impedances

### Schematic

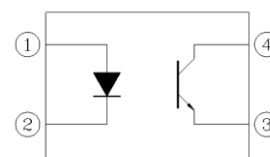

### Pin Configuration

1. Anode
2. Cathode
3. Emitter
4. Collector

**Absolute Maximum Ratings (Ta=25°C)**

	Parameter	Symbol	Rating	Unit
Input	Forward current	I <sub>F</sub>	60	mA
	Peak forward current (1us, pulse)	I <sub>FP</sub>	1.5	A
	Reverse voltage	V <sub>R</sub>	6	V
	Power dissipation	P <sub>D</sub>	100	mW
Output	Power dissipation	P <sub>C</sub>	150	mW
	Collector current	I <sub>C</sub>	50	mA
	Collector-Emitter voltage	V <sub>CEO</sub>	80	V
	Emitter-Collector voltage	V <sub>ECO</sub>	7	V
	Total Power Dissipation	P <sub>TOT</sub>	250	mW
	Isolation Voltage* <sup>1</sup>	V <sub>ISO</sub>	5000	V <sub>rms</sub>
	Operating Temperature	T <sub>OPR</sub>	-55 to 110	°C
	Storage Temperature	T <sub>STG</sub>	-55 to 125	°C
	Soldering Temperature* <sup>2</sup>	T <sub>SOL</sub>	260	°C

Notes:

\*1 AC for 1 minute, R.H.= 40 ~ 60% R.H. In this test, pins 1, 2 are shorted together, and pins 3, 4 are shorted together.

\*2 For 10 seconds

**Electro-Optical Characteristics (Ta=25°C unless specified otherwise)**

**Input**

Parameter	Symbol	Min.	Typ.	Max.	Unit	Condition
Forward Voltage	$V_F$	-	1.45	1.5	V	$I_F = 50\text{mA}$
Reverse current	$I_R$	-	-	10	$\mu\text{A}$	$V_R = 6\text{V}$
Input capacitance	$C_{in}$	-	50	-	pF	$V = 0, f = 1\text{kHz}$

**Output**

Parameter	Symbol	Min	Typ.	Max.	Unit	Condition
Collector-Emitter dark current	$I_{CEO}$	-	-	100	nA	$V_{CE} = 20\text{V}, I_F = 0\text{mA}$
Collector-Emitter breakdown voltage	$BV_{CEO}$	80	-	-	V	$I_C = 0.1\text{mA}$
Emitter-Collector breakdown voltage	$BV_{ECO}$	7	-	-	V	$I_E = 0.1\text{mA}$

**Transfer Characteristics**

Parameter	Symbol	Min	Typ.	Max.	Unit	Condition
Current Transfer ratio	EL1010	50	-	600	%	$I_F = 5\text{mA}, V_{CE} = 5\text{V}$
	EL1017	80	-	160		
	EL1018	130	-	260		
	EL1019	200	-	400		
	EL1012	63	-	125	%	$I_F = 10\text{mA}, V_{CE} = 5\text{V}$
	EL1013	100	-	200		
	EL1014	160	-	320		
	EL1012	22	-	-		
EL1013	34	-	-	%	$I_F = 1\text{mA}, V_{CE} = 5\text{V}$	
EL1014	56	-	-			
Collector-Emitter saturation voltage	$V_{CE(sat)}$	-	-	0.3	V	$I_F = 10\text{mA}, I_C = 1\text{mA}$
Isolation resistance	$R_{IO}$	$5 \times 10^{10}$	-	-	$\Omega$	$V_{IO} = 500\text{Vdc}, 40\sim 60\% \text{ R.H.}$
Floating capacitance	$C_{IO}$	-	-	1.0	pF	$V_{IO} = 0, f = 1\text{MHz}$

### Transfer Characteristics

Parameter	Symbol	Min	Typ.	Max.	Unit	Condition
Turn on time	Ton	-	4	-	μs	V <sub>CE</sub> = 5V, I <sub>C</sub> = 5mA, R <sub>L</sub> = 100Ω
Turn off time	Toff	-	3	-		
Rise time	t <sub>r</sub>	-	2	18	μs	V <sub>CE</sub> = 5V, I <sub>C</sub> = 5mA, R <sub>L</sub> = 100Ω
Fall time	t <sub>f</sub>	-	3	18		

\* Typical values at T<sub>a</sub> = 25°C

Typical Electro-Optical Characteristics Curves

Figure 1. Forward Current vs. Forward Voltage

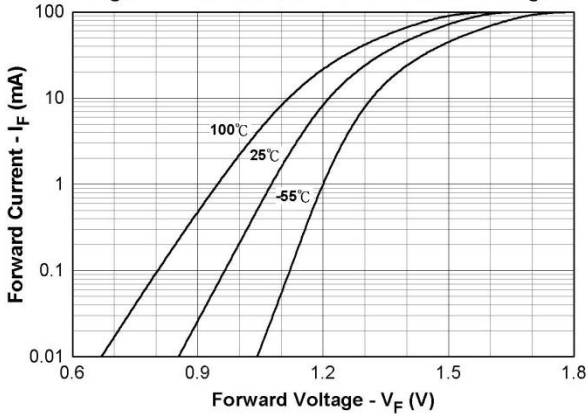

Figure.2 Collector Dark Current vs. Ambient Temperature

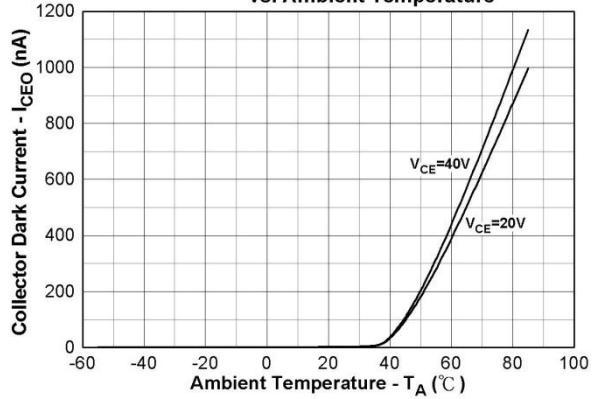

Figure 3. Collector Current vs. Collector Emitter Voltage

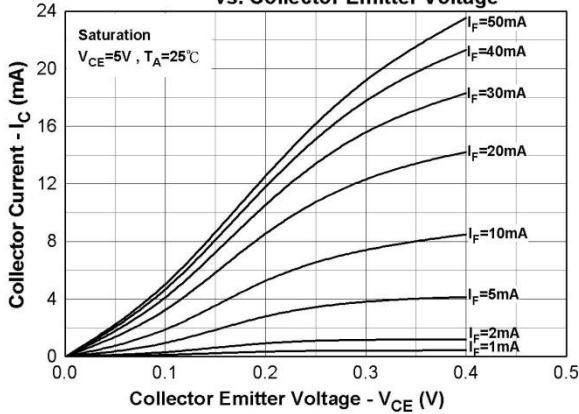

Figure 4. Collector Current vs. Collector Emitter Voltage

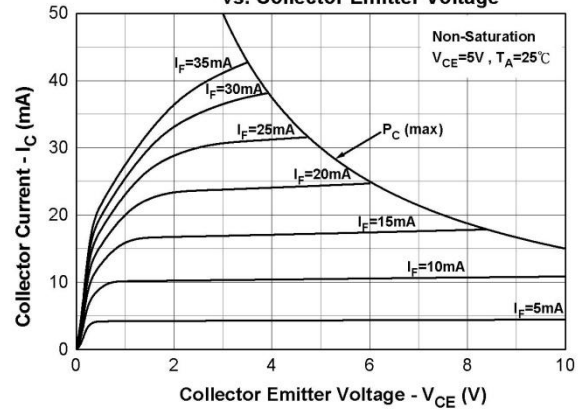

Figure 5. Normalized Collector Current vs. Forward Current

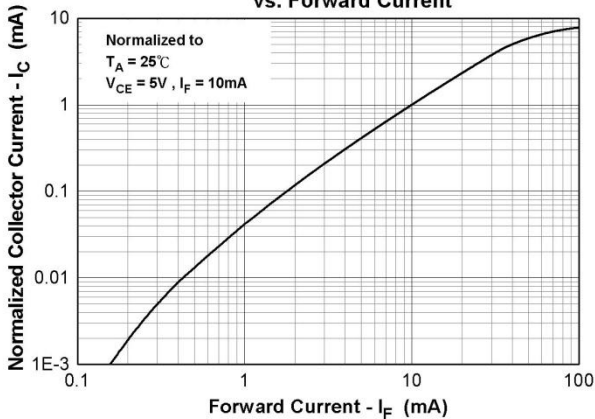

Figure 6. Normalized Current Transfer Ratio vs. Forward Current

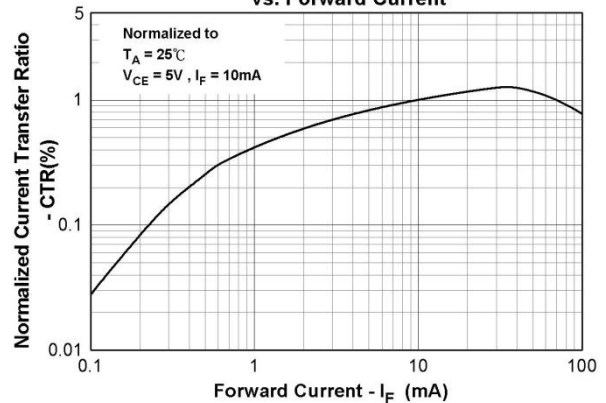

Figure 7. Normalized Current Transfer Ratio vs. Ambient Temperature

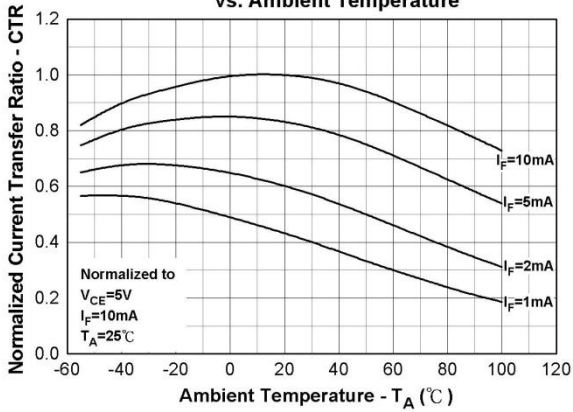

Figure 8. Normalized Current Transfer Ratio vs. Ambient Temperature

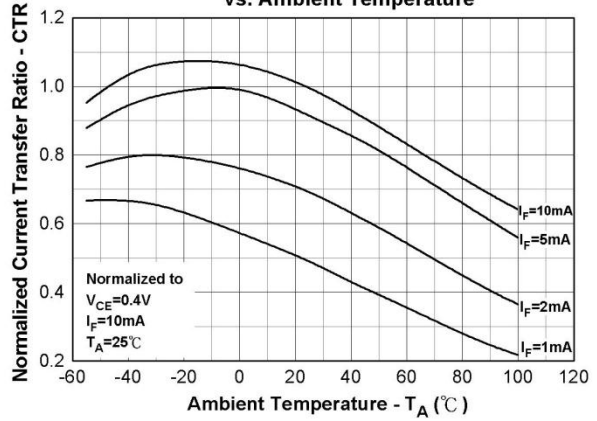

Figure 9. Turn on/off Time vs. Collector Current

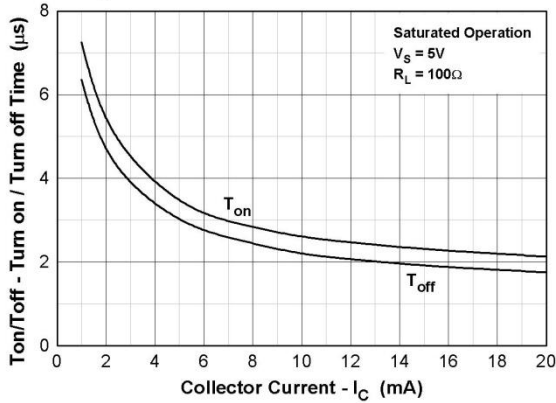

Figure 10. Turn on/off Time vs. Forward Current

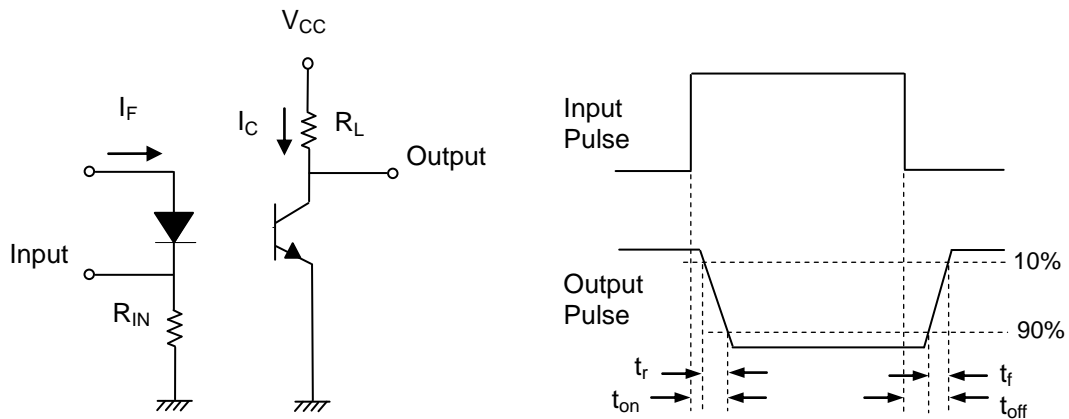
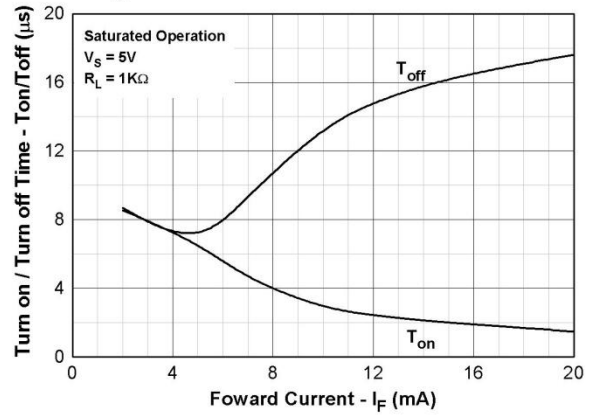

Figure 11. Switching Time Test Circuit & Waveforms

## Order Information

### Part Number

**EL101X(Y)-VG**

### Note

EL101 = Part No.

X = CTR Rank (0, 2, 3, 4, 7, 8 or 9)

Y = Tape and reel option (TA, TB or none).

V = VDE safety (optional)

G = Halogens free

Option	Description	Packing quantity
None	Standard SMD option	100 units per tube
-V	Standard SMD option + VDE	100 units per tube
(TA)	TA Tape & reel option	3000 units per reel
(TB)	TB Tape & reel option	3000 units per reel
(TA)-V	TA Tape & reel option + VDE	3000 units per reel
(TB)-V	TB Tape & reel option + VDE	3000 units per reel

Package Dimension (Dimensions in mm)

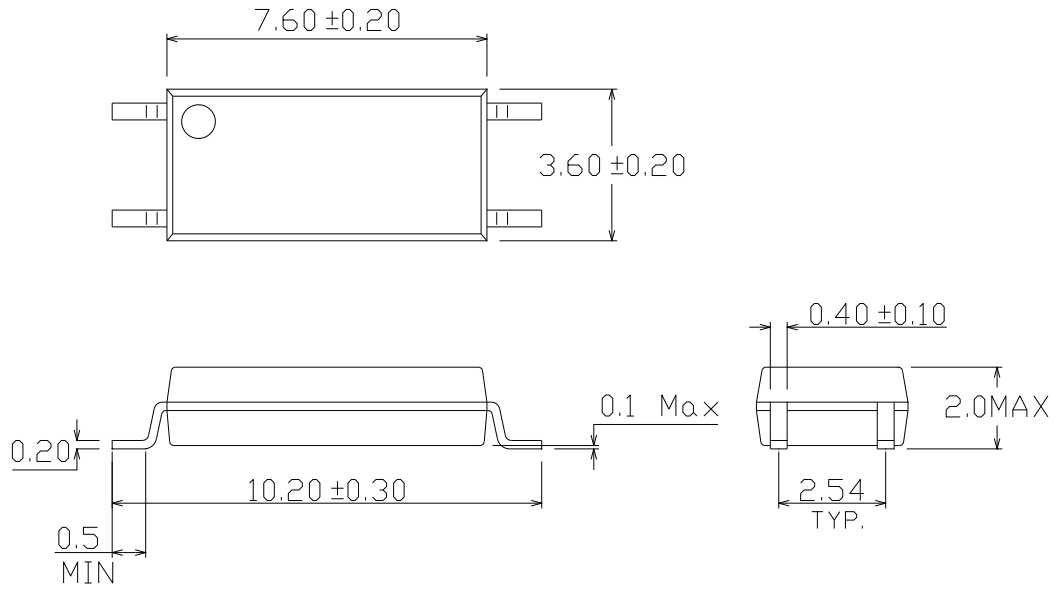

Recommended pad layout for surface mount leadform

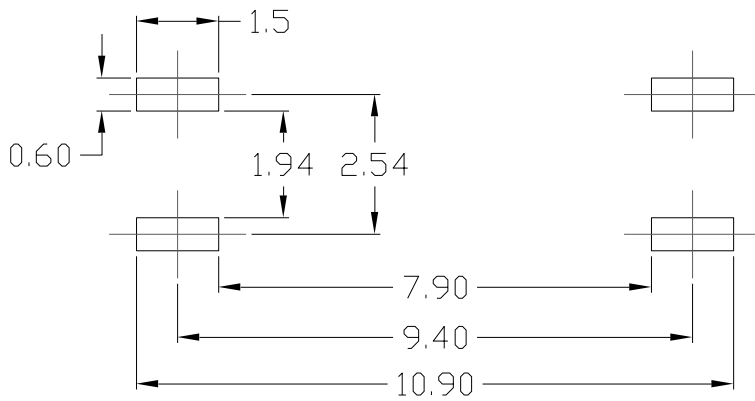



## Device Marking

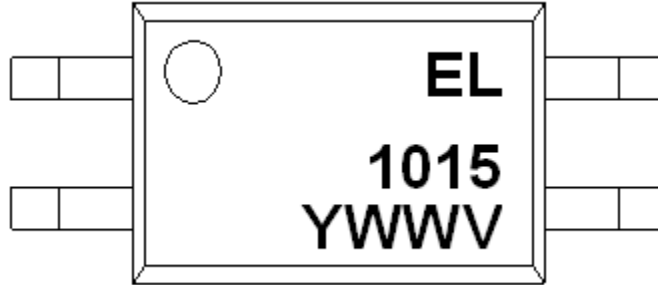

## Notes

EL	denotes Everlight
1015	denotes Device Number
Y	denotes 1 digit Year code
WW	denotes 2 digit Week code
V	denotes VDE (optional)

**Tape & Reel Packing Specifications**

**Option TA**

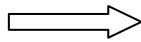
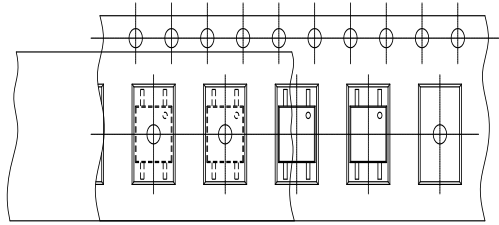

Direction of feed from reel

**Option TB**

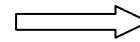
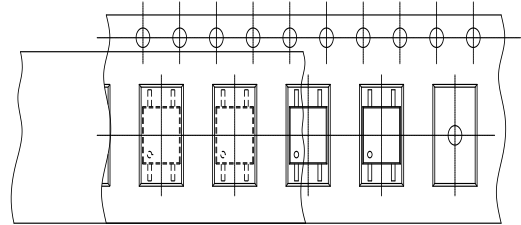

Direction of feed from reel

**Tape dimensions**

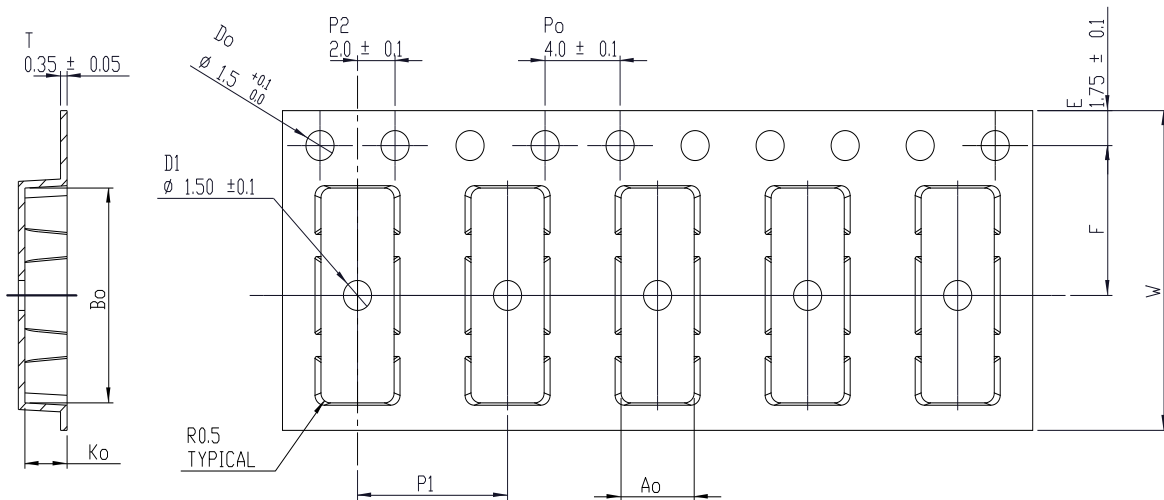

Dimension No.	<b>Ao</b>	<b>Bo</b>	<b>Do</b>	<b>D1</b>	<b>E</b>	<b>F</b>
Dimension (mm)	3.9 ± 0.10	10.75 ± 0.10	1.5 + 0.1/-0	1.5 ± 0.10	1.75 ± 0.10	7.5 ± 0.10
Dimension No.	<b>Po</b>	<b>P1</b>	<b>P2</b>	<b>T</b>	<b>W</b>	<b>Ko</b>
Dimension (mm)	4.0 ± 0.10	8.0 ± 0.10	2.0 ± 0.10	0.35 ± 0.05	16.0 ± 0.30	2.25 ± 0.10

## Precautions for Use

### 1. Soldering Condition

#### 1.1 (A) Maximum Body Case Temperature Profile for evaluation of Reflow Profile

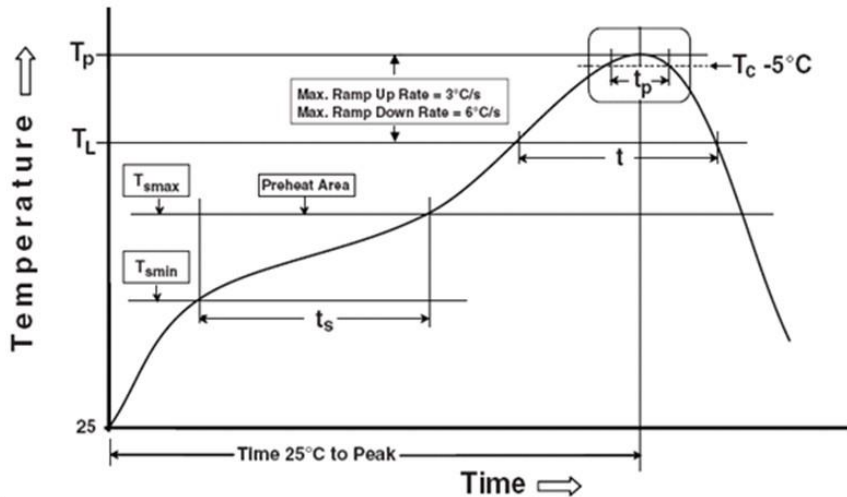

Note:

Reference: IPC/JEDEC J-STD-020D

#### Preheat

Temperature min ( $T_{smin}$ )	150 °C
Temperature max ( $T_{smax}$ )	200°C
Time ( $T_{smin}$ to $T_{smax}$ ) ( $t_s$ )	60-120 seconds
Average ramp-up rate ( $T_{smax}$ to $T_p$ )	3 °C/second max

#### Other

Liquidus Temperature ( $T_L$ )	217 °C
Time above Liquidus Temperature ( $t_L$ )	60-100 sec
Peak Temperature ( $T_p$ )	260°C
Time within 5 °C of Actual Peak Temperature: $T_p - 5^\circ C$	30 s
Ramp- Down Rate from Peak Temperature	6°C /second max.
Time 25°C to peak temperature	8 minutes max.
Reflow times	3 times

## **DISCLAIMER**

1. Above specification may be changed without notice. EVERLIGHT will reserve authority on material change for above specification.
2. When using this product, please observe the absolute maximum ratings and the instructions for using outlined in these specification sheets. EVERLIGHT assumes no responsibility for any damage resulting from use of the product which does not comply with the absolute maximum ratings and the instructions included in these specification sheets.
3. These specification sheets include materials protected under copyright of EVERLIGHT corporation. Please don't reproduce or cause anyone to reproduce them without EVERLIGHT's consent.

单击下面可查看定价，库存，交付和生命周期等信息

[>>Everlight \(亿光\)](#)