

Technical Data Sheet

5mm Infrared LED , T-1 3/4

IR533C



Feature

- High reliability
- High radiant intensity
- Peak wavelength $\lambda_p=940\text{nm}$
- 2.54mm Lead spacing
- Low forward voltage
- Pb Free
- Compliance with EU REACH
- Compliance Halogen Free(Br < 900ppm, Cl < 900ppm, Br+Cl < 1500ppm)

Descriptions

- EVERLIGHT's Infrared Emitting Diode (IR533C) is a high intensity diode , molded in a blue plastic package.
- The device is spectrally matched with phototransistor , photodiode and infrared receiver module.

Applications

- Free air transmission system
- Infrared remote control units with high power requirement
- Smoke detector
- Infrared applied system

Device Selection Guide

LED Part No.	Chip	Lens Color
	Material	
IR533C	GaAlAs	Water Clear

Package Dimensions

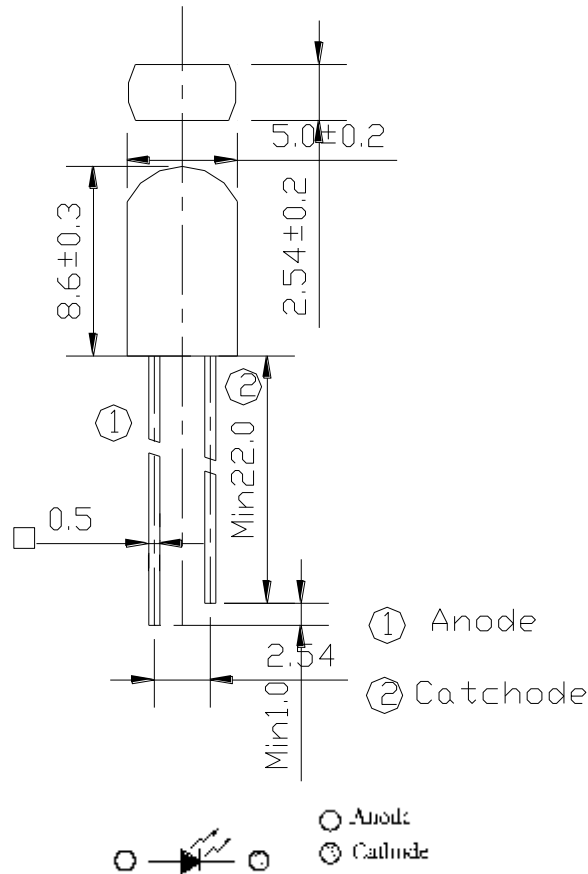

- Notes:**
1. All dimensions are in millimeters
 2. Tolerances unless dimensions ± 0.25 mm

Absolute Maximum Ratings (Ta=25°C)

Parameter	Symbol	Rating	Units
Continuous Forward Current	I _F	100	mA
Peak Forward Current	I _{FP}	1.0	A
Reverse Voltage	V _R	5	V
Operating Temperature	T _{opr}	-40 ~ +85	°C
Storage Temperature	T _{stg}	-40 ~ +100	°C
Soldering Temperature	T _{sol}	260	°C
Power Dissipation at(or below) 25°C Free Air Temperature	P _d	150	mW

Notes: *1:I_{FP} Conditions--Pulse Width ≤ 100 μs and Duty ≤ 1%.

*2:Soldering time ≤ 5 seconds.

Electro-Optical Characteristics (Ta=25°C)

Parameter	Symbol	Condition	Min.	Typ.	Max.	Units
Radiant Intensity	I _e	I _F =20mA	4.0	7.8	--	mW/sr
		I _F =100mA Pulse Width ≤ 100 μs ,Duty ≤ 1%	--	35	--	
		I _F =1A Pulse Width ≤ 100 μs ,Duty ≤ 1%.	--	350	--	
Peak Wavelength	λ _p	I _F =20mA	--	940	--	nm
Spectral Bandwidth	Δλ	I _F =20mA	--	45	--	nm
Forward Voltage	V _F	I _F =20mA		1.2	1.5	V
		I _F =100mA Pulse Width ≤ 100 μs ,Duty ≤ 1%	--	1.4	1.85	
		I _F =1A Pulse Width ≤ 100 μs ,Duty ≤ 1%.	--	2.6	4.0	
Reverse Current	I _R	V _R =5V	--	--	10	μA
View Angle	2θ 1/2	I _F =20mA	--	25	--	deg

Rank

Condition : $I_F=20\text{mA}$

Unit : mW/sr

Bin Number	K	L	M	N	P
Min	4.0	5.6	7.8	11.0	15.0
Max	6.4	8.9	12.5	17.6	24.0

Note:

*Measurement Uncertainty of Forward Voltage: $\pm 0.1\text{V}$

*Measurement Uncertainty of Luminous Intensity: $\pm 10\%$

*Measurement Uncertainty of Dominant Wavelength $\pm 1.0\text{nm}$

Typical Electro-Optical Characteristics Curves

Fig.1 Forward Current vs.

Ambient Temperature

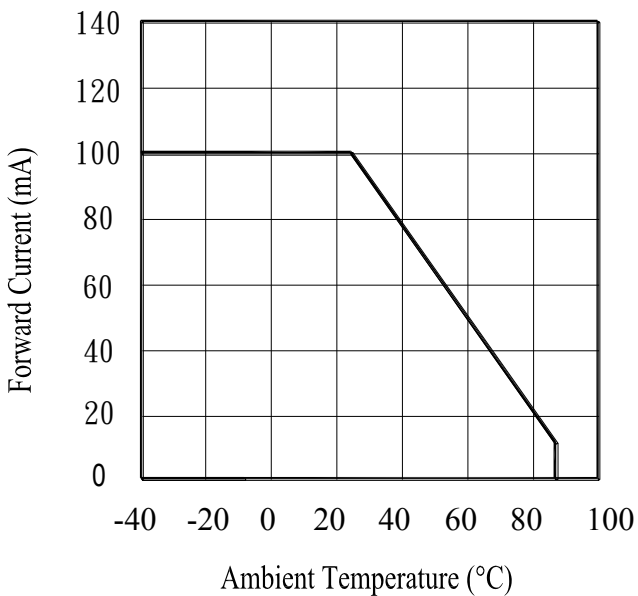

Fig.2 Spectral Distribution

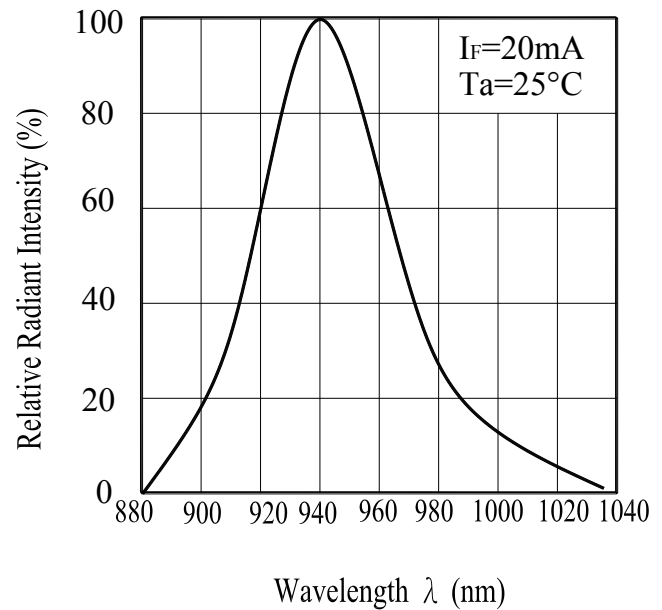

Fig.3 Peak Emission Wavelength
Ambient Temperature

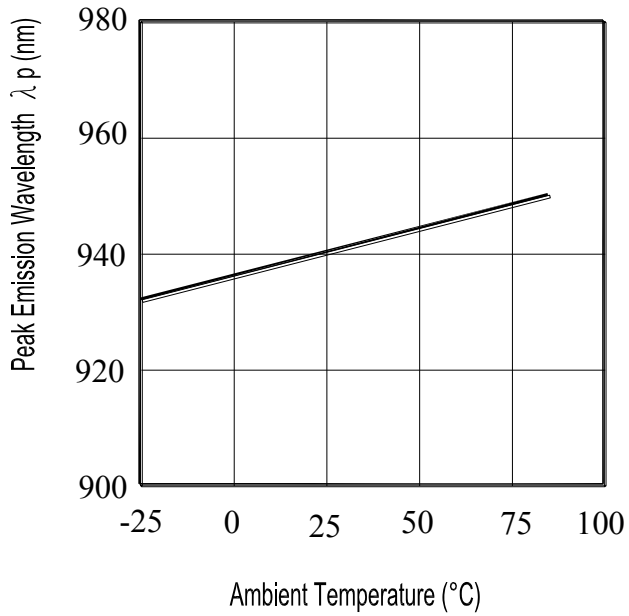
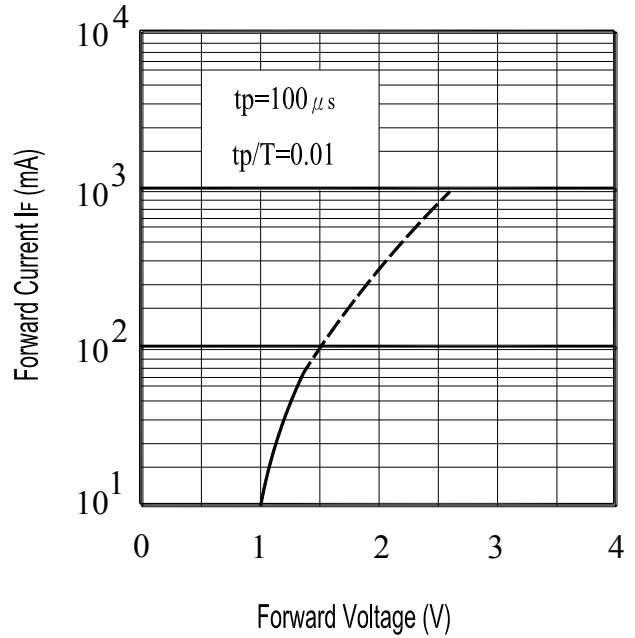

Fig.4 Forward Current
vs. Forward Voltage



Typical Electro-Optical Characteristics Curves

Fig.5 Relative Intensity vs.
Forward Current

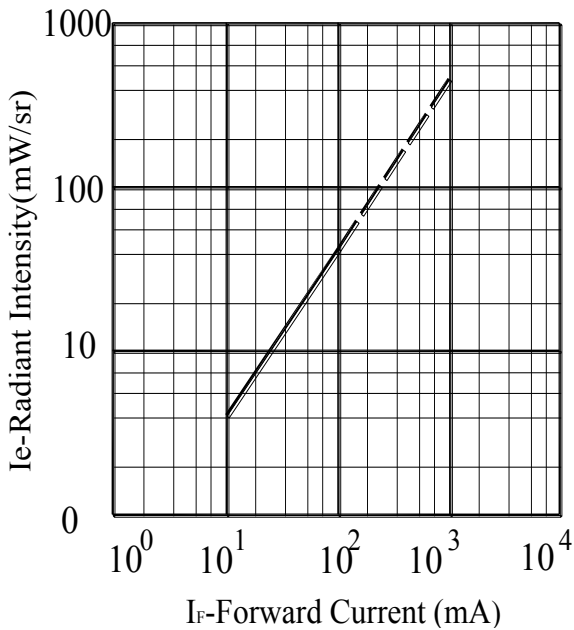

Fig.6 Relative Radiant Intensity vs.
Angular Displacement

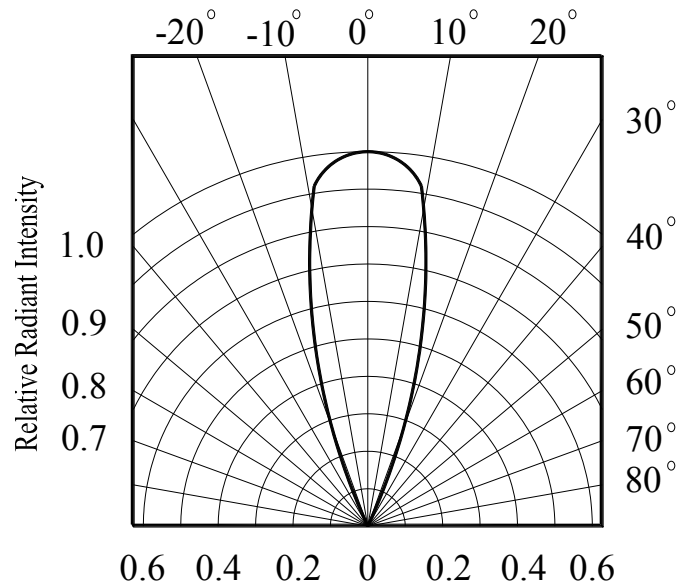

Fig.7 Relative Intensity vs.
Ambient Temperature(°C)

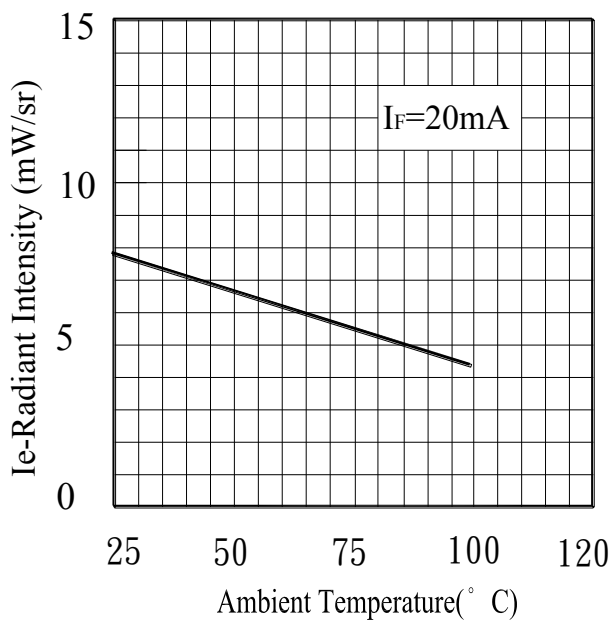
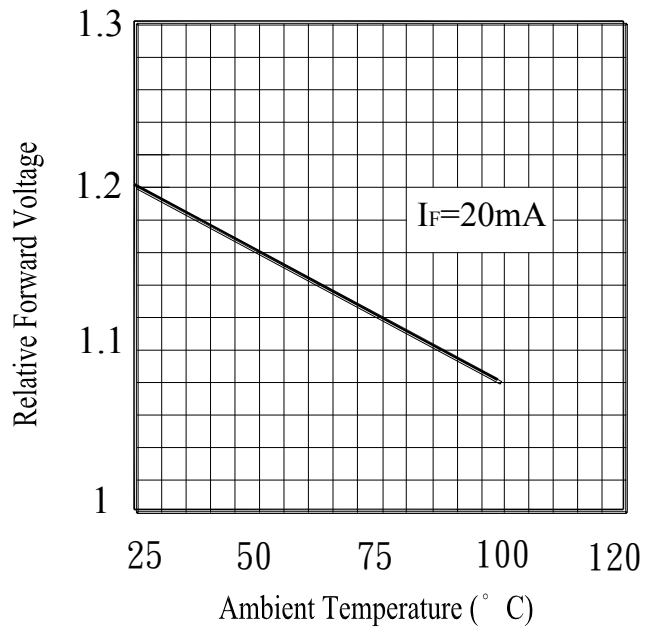

Fig.8 Forward Voltage vs.
Ambient Temperature(°C)



Packing Quantity Specification

1. 200~500PCS/1Bag,5Bag/1Box
2. 10Boxes/1Carton

Label Form Specification

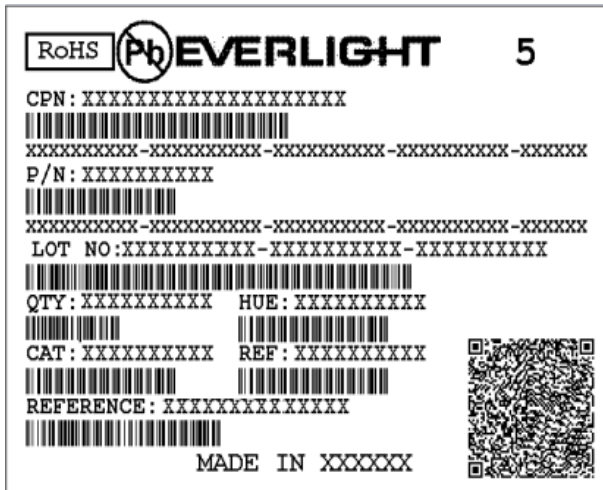

CPN: Customer's Production Number

P/N : Production Number

QTY: Packing Quantity

CAT: Ranks

HUE: Peak Wavelength

REF: Reference

LOT No: Lot Number

DISCLAIMER

1. EVERLIGHT reserves the right(s) on the adjustment of product material mix for the specification.
2. The product meets EVERLIGHT published specification for a period of twelve (12) months from date of shipment.
3. The graphs shown in this datasheet are representing typical data only and do not show guaranteed values.
4. When using this product, please observe the absolute maximum ratings and the instructions for using outlined in these specification sheets. EVERLIGHT assumes no responsibility for any damage resulting from the use of the product which does not comply with the absolute maximum ratings and the instructions included in these specification sheets.
5. These specification sheets include materials protected under copyright of EVERLIGHT. Reproduction in any form is prohibited without obtaining EVERLIGHT's prior consent.
6. This product is not intended to be used for military, aircraft, automotive, medical, life sustaining or life saving applications or any other application which can result in human injury or death. Please contact authorized Everlight sales agent for special application request.

单击下面可查看定价，库存，交付和生命周期等信息

[>>Everlight \(亿光\)](#)