

Opto Interrupter ITR9707



Features

- Fast response time
- High sensitivity
- Cut-off visible wavelength $\lambda_p=940\text{nm}$
- Pb free
- This product itself will remain within RoHS compliant version
- Compliance with EU REACH

Description

- The ITR9707 consist of an infrared emitting diode and an silicon phototransistor, encased side-by-side on converging optical axis in a black thermoplastic housing,
- The phototransistor receives radiation from the IR LED only .This is the normal situation.
- But when an object is in between , phototransistor could not receives the radiation.
- For additional component information , please refer to IR908-7C and PT908-7C

Applications

- Mouse Copier
- Switch Scanner
- Floppy disk driver
- Non-contact Switching
- For Direct Board

Device Selection Guide

Device No.	Chip Material	Lens Color
IR	GaAlAs	Water clear
PT	Silicon	Water Clear

Absolute Maximum Ratings (Ta=25°C)

Parameter		Symbol	Ratings	Units
Input	Power Dissipation at (or below) 25°C Free Air Temperature	Pd	75	mW
	Reverse Voltage	V _R	5	V
	Continuous Forward Current	I _F	50	mA
Output	Power Dissipation at (or below) 25°C Free Air Temperature	Pd	75	mW
	Collector Current	I _c	20	mA
	Collector-Emitter Voltage	BV _{CEO}	30	V
	Emitter-Collector Voltage	BV _{ECO}	5	V
Operating Temperature		Topr	-25~+85	°C
Storage Temperature		Tstg	-40~+85	°C
Lead Soldering Temperature *1 (3mm from the package)		Tsol	260	°C

Notes: *1. Soldering time ≤ 5 sec.

Electro-Optical Characteristics (Ta=25°C)

Parameter		Conditions	Symbol	Min.	Typ.	Max.	Unit
Input	Forward Voltage	I _F =20mA	V _F	---	1.2	1.5	V
	Reverse Current	V _R =5V	I _R	---	---	10	μA
	Peak Wavelength	I _F =20mA	λ _P	---	940	---	nm
Output	Collector Dark Current	V _{CE} =20V E _e =0mW/cm ²	I _{CEO}	---	---	100	nA
	Collector-Emitter Saturation Voltage	I _C =2mA E _e =1mW/cm ²	V _{CE(sat)}	---	---	0.4	V
Transfer Characteristics	On State Collector Current	V _{CE} =5V I _F =20mA	I _{C(on)}	0.5	---	---	mA
	Rise time	V _{CE} =5V I _C =1mA R _L =1KΩ	t _r	---	15	---	μsec
	Fall time		t _f	---	15	---	μsec

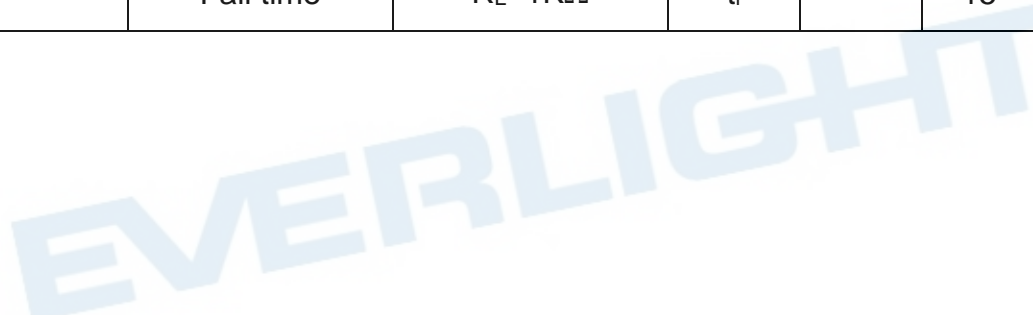

Typical Electrical/Optical/Characteristics Curves for IR

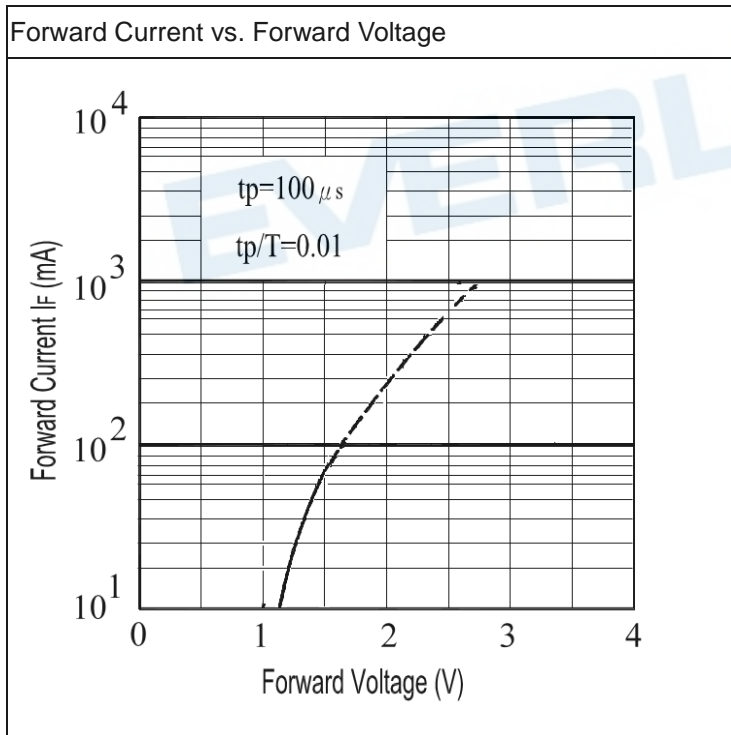
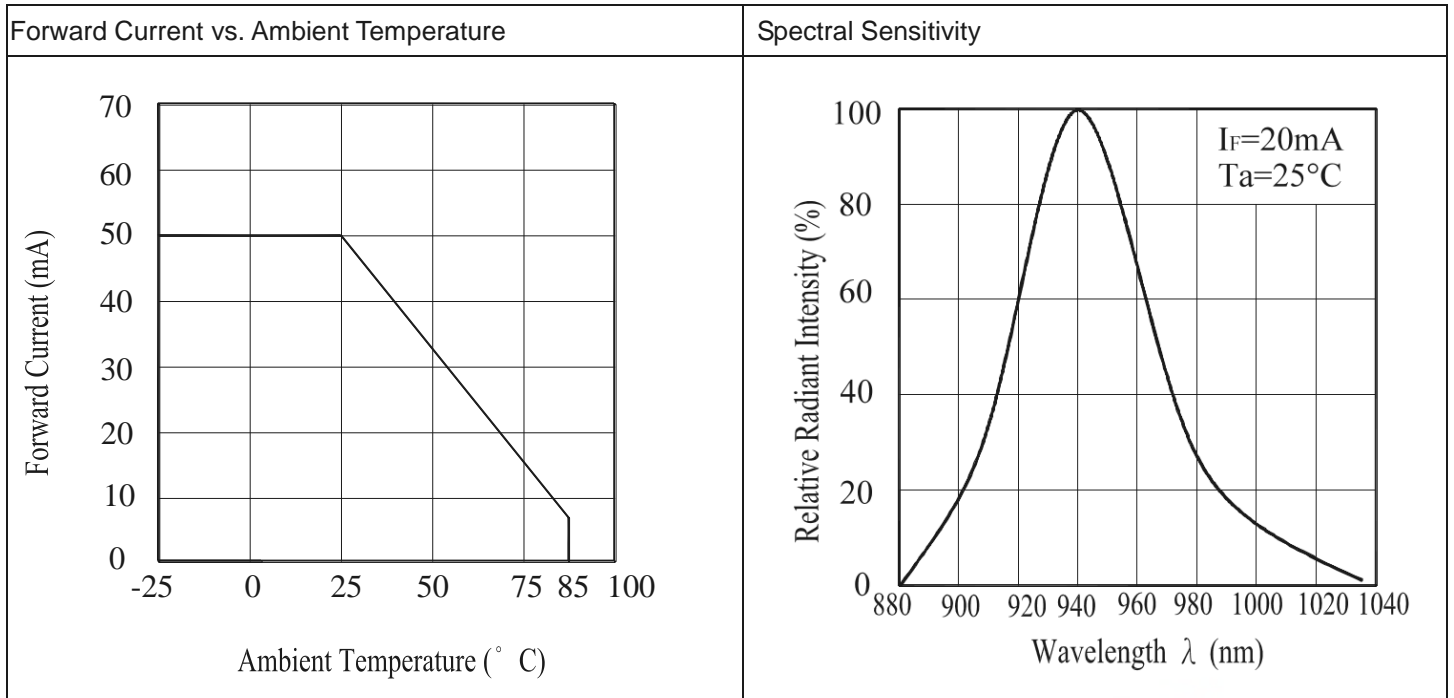

Typical Electrical/Optical/Characteristics Curves for PT

Spectral Sensitivity e

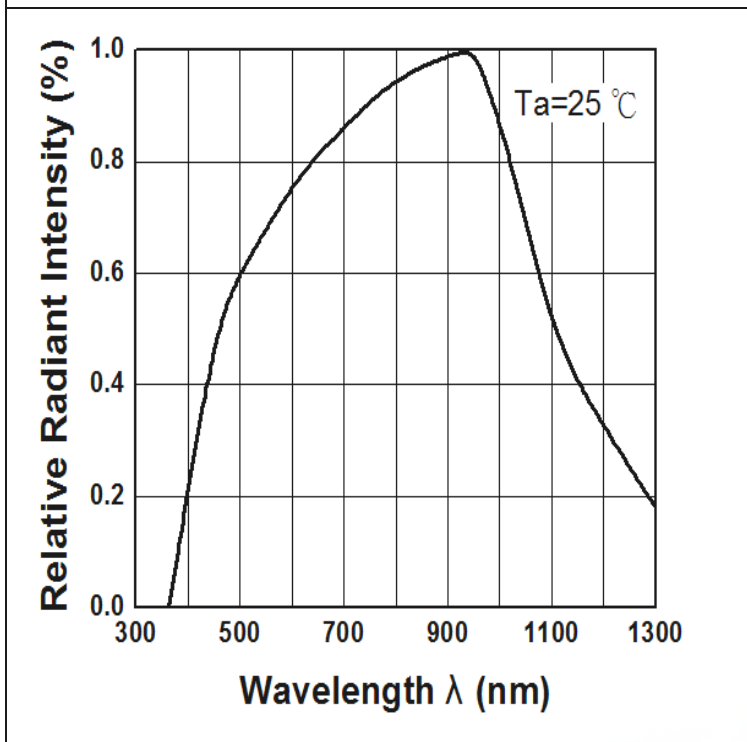

EVERLIGHT

Package Dimension

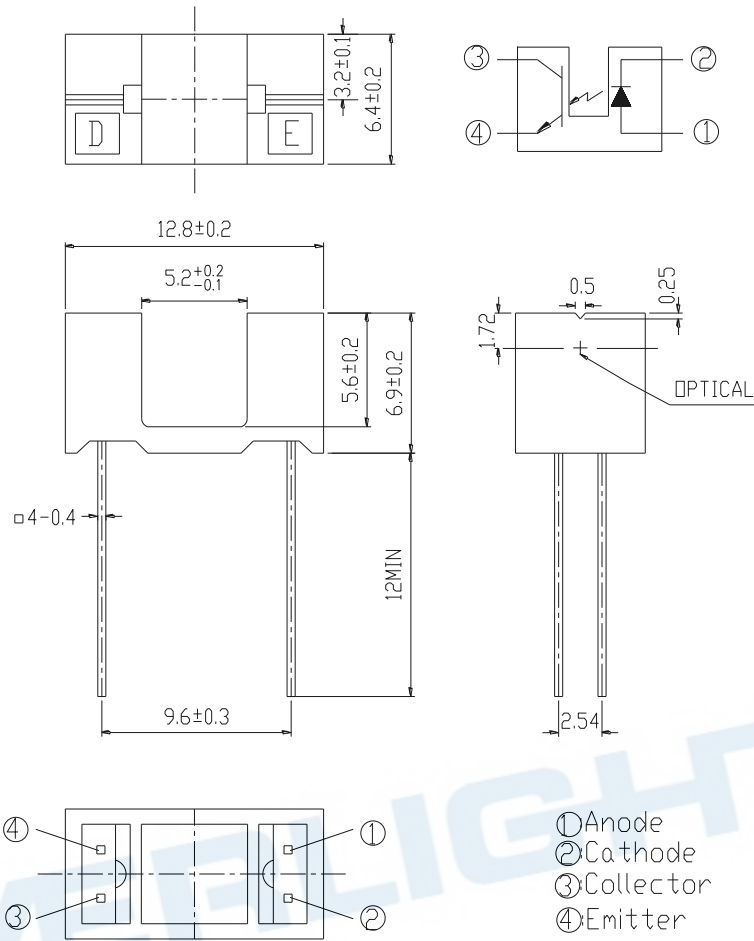

Notes:

1. All dimensions are in millimeters.
2. Tolerances unless dimensions ± 0.3 mm.
3. Lead spacing is measured where the lead emerge from the package.

Packing Quantity Specification

1. 78Pcs/1Tube,42 Tubes/1Box
2. 4Boxes/1Carton

Label Form Specification

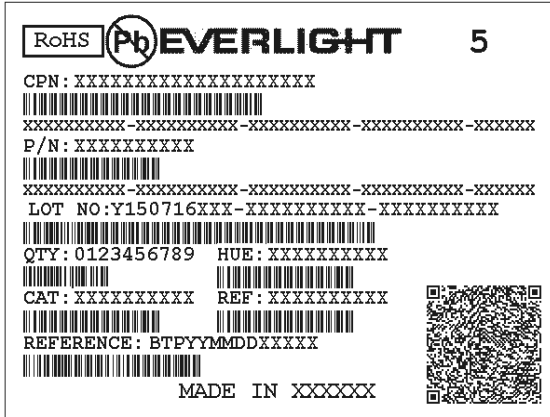

- CPN: Customer Part Number
- P/N: Part Number
- QTY: Packing Quantity
- REF: Reference
- LOT No: Lot Number

Notes

Lead Forming

1. During lead frame bending, the lead frame should be bent at a distance more than 3mm from bottom of the epoxy.
Note: Must fix lead frame and do not touch epoxy before bending to avoid Photo Interrupter broken.
2. Lead forming should be done before soldering.
3. Avoid stressing the Photo Interrupter package during leads forming. The stress to the base may damage the characteristics of Photo Interrupter, or it may break the Photo Interrupter.
4. Cut the Photo Interrupter lead frame at room temperature. Cutting the lead frame at high temperatures may cause failure of the Photo Interrupter.
5. When mounting the Photo Interrupter onto a PCB, the PCB holes must be aligned exactly with the lead position of the Photo Interrupter. If the Photo Interrupter are mounted with stress at the leads, it causes deterioration of the epoxy resin and this will degrade the Photo Interrupter.

Storage

1. The Photo Interrupter should be stored at 10~30°C and 70%RH or less after being shipped from Everlight and the storage life limits are 3 months. If the Photo Interrupter are stored for 3 months or more, they can be stored at 10°C~25°C and 20%RH~60%RH for a year in a sealed container with a nitrogen atmosphere. After opening the package, the devices must be stored at 10°C~25°C and 20%RH~60%RH, and suggested to be used within 24 hours or as soon as possible. Besides, suggest that the remaining devices seal in the package bag as soon as possible please.
2. Please avoid rapid transitions in ambient temperature, especially in high humidity environments where condensation can occur.

Soldering

- Careful attention should be paid during soldering. When soldering, leave more than 3mm from solder joint to epoxy bulb, and soldering beyond the base of the tie bar is recommended.
- Recommended soldering conditions:

Hand Soldering		DIP Soldering	
Temp. at tip of iron	300°C Max. (30W Max.)	Preheat temp.	100°C Max. (60 sec Max.)
Soldering time	3 sec Max.	Bath temp. & time	260 Max., 5 sec Max
Distance	3mm Min.(From solder joint to epoxy bulb)	Distance	3mm Min. (From solder joint to epoxy bulb)

- Recommended soldering profile

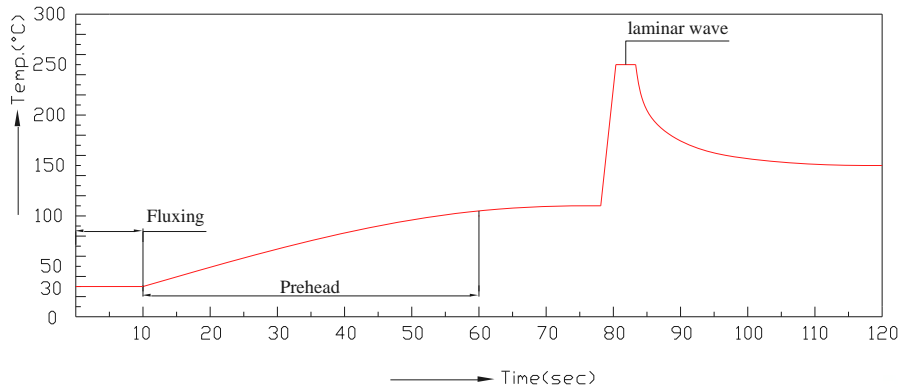

- Avoiding applying any stress to the lead frame while the Photo Interrupter are at high temperature particularly when soldering.
- Dip and hand soldering should not be done more than one time
- After soldering the Photo Interrupter, the epoxy bulb should be protected from mechanical shock or vibration until the Photo Interrupter return to room temperature.
- A rapid-rate process is not recommended for cooling the Photo Interrupter down from the peak temperature.
- Although the recommended soldering conditions are specified in the above table, dip or hand soldering at the lowest possible temperature is desirable for the Photo Interrupter.
- Wave soldering parameter must be set and maintain according to recommended temperature and dwell time in the solder wave.

Cleaning

Do not clean the Photo Interrupter by the ultrasonic.

Heat Management

- Heat management of Photo Interrupter must be taken into consideration during the design stage of Photo Interrupter application. The current should be de-rated appropriately by referring to the de-rating curve found in each product specification.
- The temperature surrounding the Photo Interrupter in the application should be controlled.

ESD (Electrostatic Discharge)

1. The products are sensitive to static electricity or surge voltage. ESD can damage a die and its reliability.
2. When handling the products, the following measures against electrostatic discharge are strongly recommended:
 - Eliminating the charge
 - Grounded wrist strap, ESD footwear, clothes and floors
 - Grounded workstation equipment and tools
 - ESD table/shelf mat made of conductive materials
3. Proper grounding is required for all devices, equipment, and machinery used in product assembly. Surge protection should be considered when designing of commercial products.
4. If tools or equipment contain insulating materials such as glass or plastic, the following measures against electrostatic discharge are strongly recommended:
 - Dissipating static charge with conductive materials
 - Preventing charge generation with moisture
 - Neutralizing the charge with ionizers

DISCLAIMER

1. EVERLIGHT reserves the right(s) on the adjustment of product material mix for the specification.
2. The product meets EVERLIGHT published specification for a period of twelve (12) months from date of shipment.
3. The graphs shown in this datasheet are representing typical data only and do not show guaranteed values.
4. When using this product, please observe the absolute maximum ratings and the instructions for using outlined in these specification sheets. EVERLIGHT assumes no responsibility for any damage resulting from the use of the product which does not comply with the absolute maximum ratings and the instructions included in these specification sheets.
5. These specification sheets include materials protected under copyright of EVERLIGHT. Reproduction in any form is prohibited without obtaining EVERLIGHT's prior consent.
6. This product is not intended to be used for military, aircraft, automotive, medical, life sustaining or life saving applications or any other application which can result in human injury or death. Please contact authorized Everlight sales agent for special application request.

单击下面可查看定价，库存，交付和生命周期等信息

[>>Everlight \(亿光\)](#)