

DATASHEET



ELUA3535NU3 4W Series

Introduction

The ELUA3535NU3 product series is a ceramic based LED with high quality and reliability that suitable for UV application.



Features

- ◆ High power UVA LED
- ◆ Dimension 3.75mm* 3.75mm* 3.2mm
- ◆ ESD protection up to 2KV
- ◆ RoHS compliant
- ◆ Pb free
- ◆ EU REACH compliant
- ◆ Halogen Free compliant
(Br<900ppm,Cl<900ppm,Br+Cl<1500ppm)

Applications

- ◆ UV Sterilization System
- ◆ UV Photo-catalyst
- ◆ UV Sensor Light

Product Nomenclature

ELUA3535NU3-PXXXXYY36481K0-V41G

EL = Everlight

UA = UVA

3535 = 3.75mm x 3.75mm Package

N = Package Material: AlN

U = Coating: Au

3 = Angle: 30°

P = Peak Wavelength

XXXX = Wavelength Range [1]

YY = Minimum Radiant Flux

3648 = Forward Voltage Spec: 3.6~4.8V

1K0= Forward Current: 1000mA

700= Forward Current: 700 mA (Only 365nm)

V = Chip Type: Vertical

4 = Chip Size: 43mil

1 = Chip QTY: 1 chip

G = Process Type: Quartz Glass

Notes:

1. Wavelength Range

Symbol	Description
6070	360~370nm
8090	380~390nm
9000	390~400nm
0010	400~410nm

Absolute Maximum Ratings

Parameter	Symbol	Ratings	Unit
Max. DC Forward Current (mA) (For 385nm · 395nm · 405nm)	I_F	1250	mA
Max. DC Forward Current (mA)(Only 365nm)	I_F	700	mA
Max. ESD Resistance	V_B	2000	V
Thermal Resistance	R_{th}	4	°C/W
Max. Junction Temperature	T_J	105	°C
Operating Temperature	T_{Opr}	-10 ~ +100	°C
Storage Temperature	T_{Stg}	-40 ~ +100	°C

PN of the ELUA3535NU3 series: UVA LEDs

Order Code of ELUA3535NU6	Minimum Radiant Flux(mW)	Typical Radiant Flux (mW)	Maximum Radiant Flux (mW)	Peak Wavelength (nm)	Forward Voltage (V)	Forward Current (mA)
ELUA3535NU3-P6070U23648700-V41G	900	1300	1600	360~370	3.6~4.8	700
ELUA3535NU3-P8090U5136481K0-V41G	1350	1475	1850	380~390	3.6~4.8	1000
ELUA3535NU3-P9000U5136481K0-V41G	1350	1475	1850	390~400	3.6~4.8	1000
ELUA3535NU3-P0010U5136481K0-V41G	1350	1475	1850	400~410	3.6~4.8	1000

Product Binning

Radiant Flux Bins

365 Bin Code	Minimum Radiant Flux (mW)	Maximum Radiant Flux (mW)
U1	900	1000
U2	1000	1200
U3	1200	1400
U4	1400	1600

385-405 Bin Code	Minimum Radiant Flux (mW)	Maximum Radiant Flux (mW)
U51	1350	1600
U52	1600	1850

Notes:

1. Radiant flux measurement tolerance: $\pm 10\%$.
2. Forward voltage bins are defined at $I_f=1000\text{mA}$ operation. (For 385nm · 395nm · 405nm)
3. Forward voltage bins are defined at $I_f=700\text{mA}$ operation. (For 365nm)

Peak Wavelength Bins

Bin Code	Minimum Peak Wavelength (nm)	Maximum Peak Wavelength (nm)
U36	360	370
U38	380	390
U39	390	400
U40	400	410

Notes:

1. Peak Wavelength measurement tolerance: $\pm 1\text{nm}$.
2. Forward voltage bins are defined at $I_f=1000\text{mA}$ operation. (For 385nm · 395nm · 405nm)
3. Forward voltage bins are defined at $I_f=700\text{mA}$ operation. (For 365nm)

Forward Voltage Bins

Bin	Minimum Forward Voltage (V)	Maximum Forward Voltage (V)
3640	3.6	4.0
4044	4.0	4.4
4448	4.4	4.8

Notes:

1. Forward voltage measurement tolerance: $\pm 2\%$.
2. Forward voltage bins are defined at $I_f=1000\text{mA}$ operation. (For 385nm · 395nm · 405nm)
3. Forward voltage bins are defined at $I_f=700\text{mA}$ operation. (For 365nm)

Mechanical Dimension

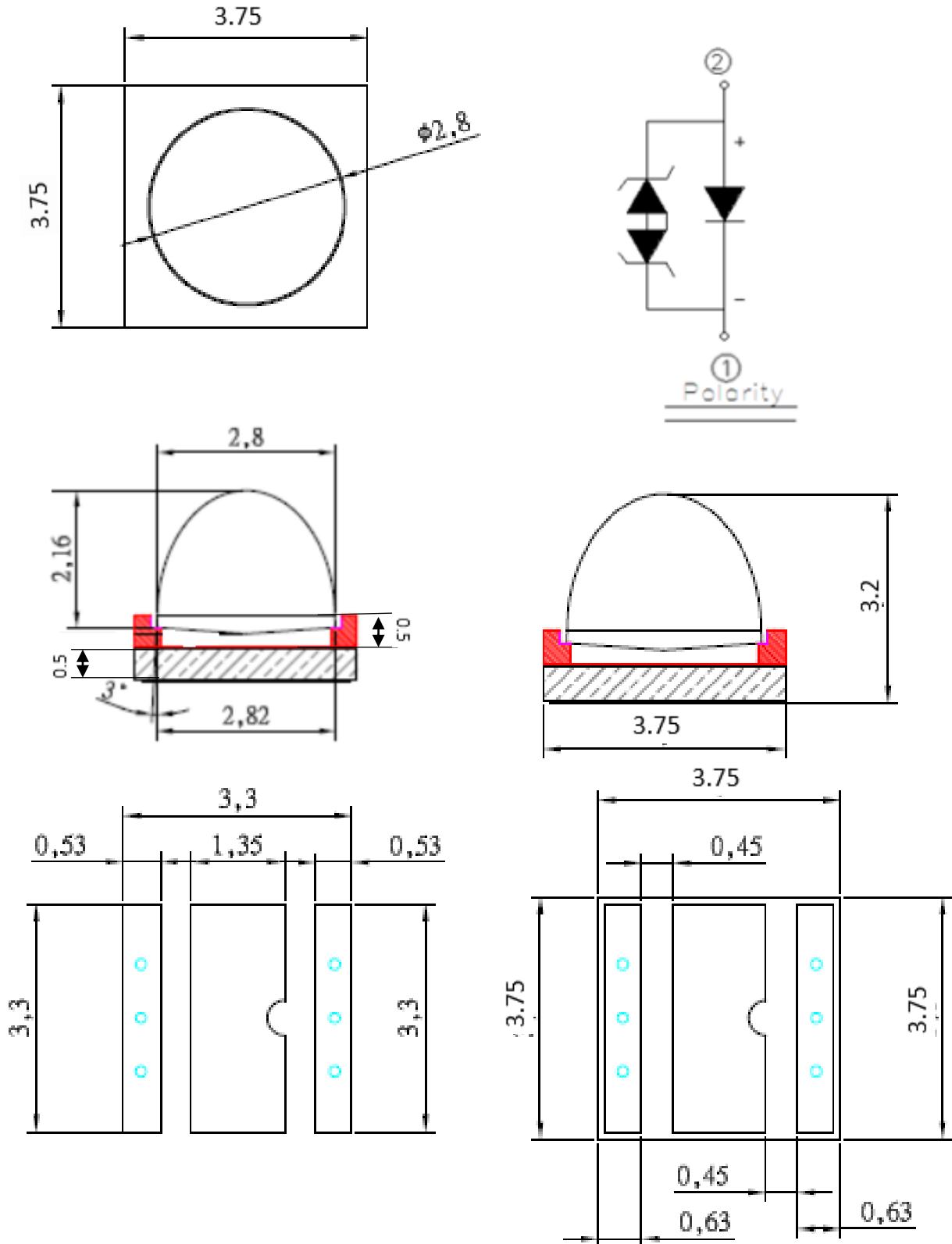

1. Dimensions are in millimeters.
2. General tolerance: $\pm 0.1\text{mm}$
3. Thickness tolerance: $\pm 0.15\text{mm}$ Unit : mm

Pad Configuration

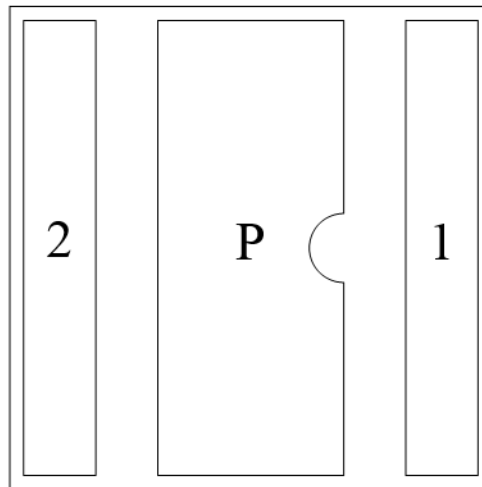

BOTTOM VIEW

PAD	FUNCTION
1	CATHODE
2	ANODE
P	THERMAL PAD

Reflow Soldering Characteristics

For Reflow Process

- ELUA series are suitable for SMT processes.
- Curing of glue in oven must be according to standard operation flow processes.

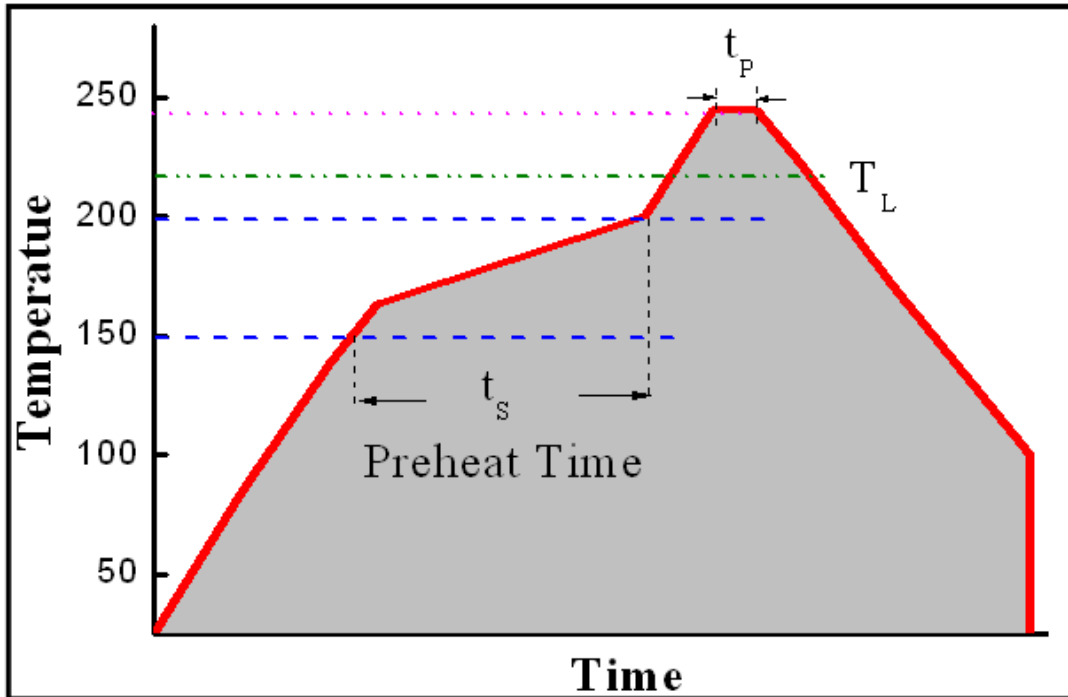

Profile Feature	Lead Free Assembly
Ramp-Up Rate	2-3 °C/S
Preheat Temperature	150-200 °C
Preheat Time (t_s)	60-120 S
Liquid Temperature (T_L)	217 °C
Time maintained above T_L	60-90 S
Peak Temperature (T_p)	240±5 °C
Peak Time (t_p)	Max 20 S
Ramp-Down Rate	3-5 °C/S

- Reflow soldering should not be done more than twice.
- In soldering process, stress on the LEDs during heating should be avoided.
- After soldering, do not bend the circuit board.

Typical Characteristics Curves Spectrum @ Thermal Pad Temperature = 25°C

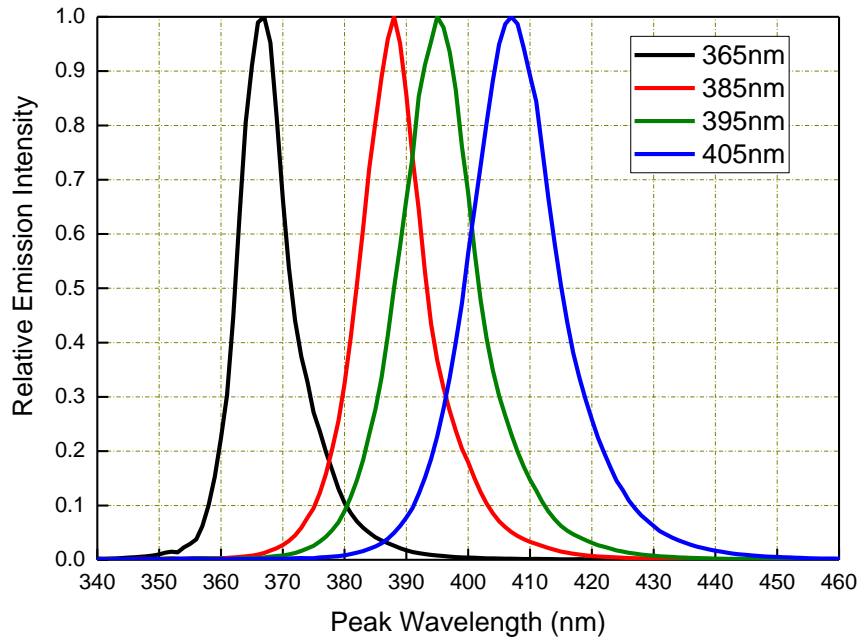

Relative Radiant Flux vs. Forward Current @ Thermal Pad Temperature = 25°C

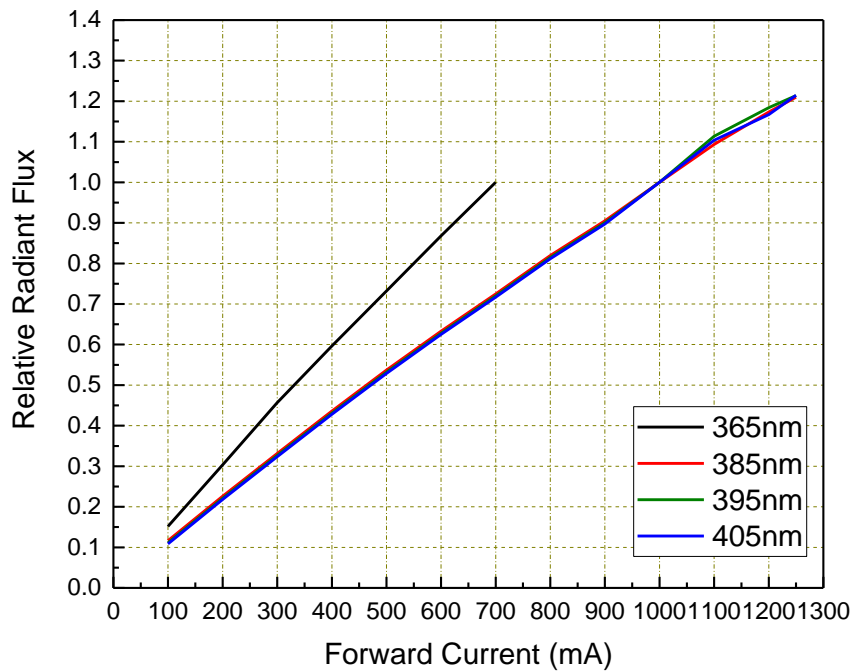

Peak Wavelength vs. Forward Current
@ Thermal Pad Temperature = 25°C

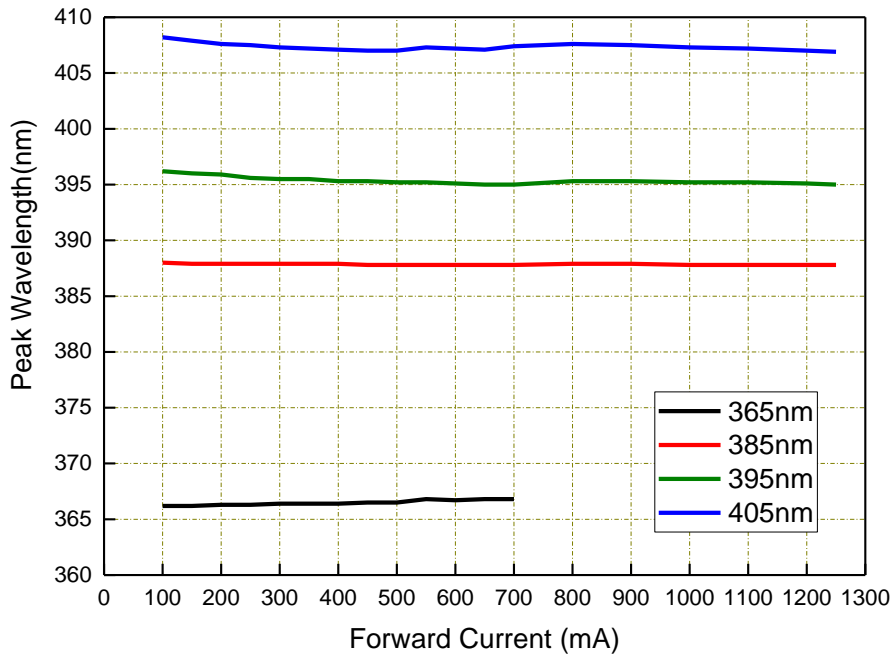

Forward Voltage vs. Forward Current
@ Thermal Pad Temperature = 25°C

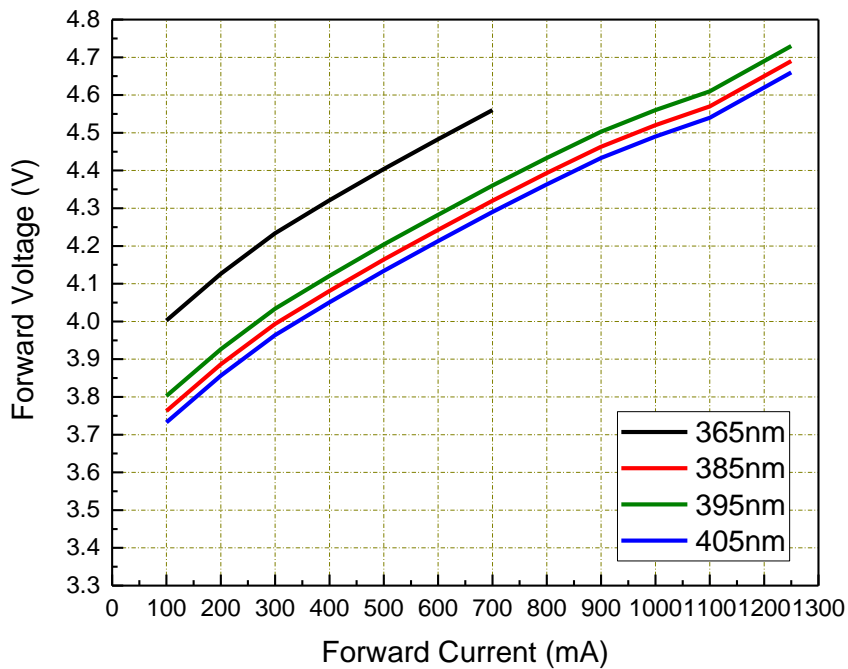

Relative Radiant Flux vs. Ambient Temperature
@ Forward Current = 1000mA (For 385nm 、395nm 、405nm)
@ Forward Current = 700mA (For 365nm)

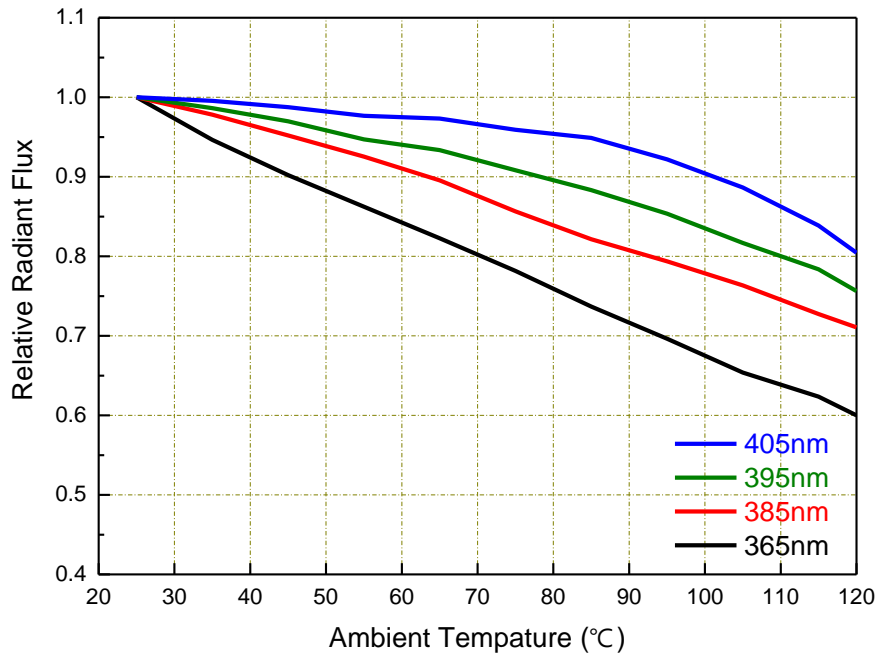

Peak Wavelength vs. Ambient Temperature
@ Forward Current = 1000mA (For 385nm 、395nm 、405nm)
@ Forward Current = 700mA (For 365nm)

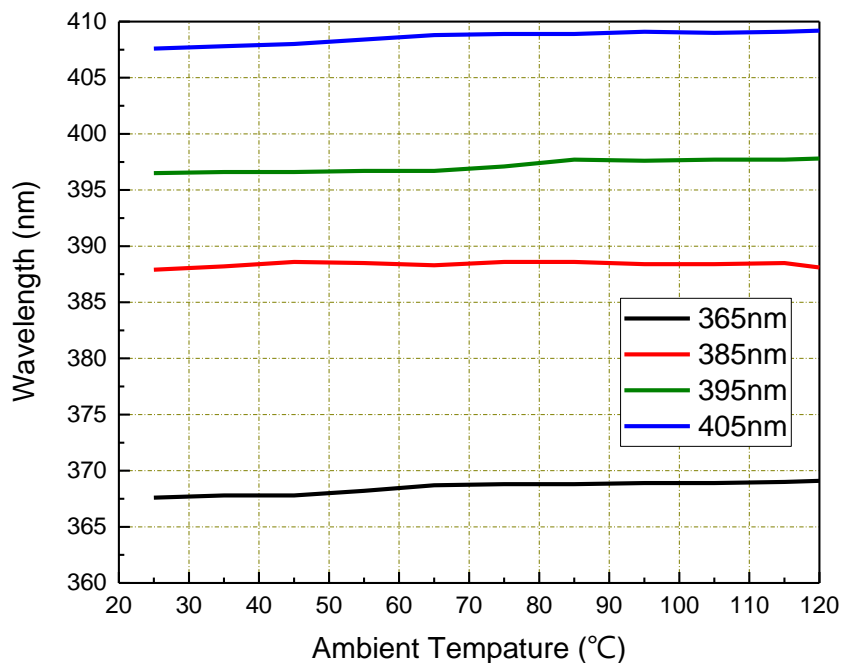

Forward Voltage vs. Ambient Temperature
 @ Forward Current = 1000mA (For 385nm、395nm、405nm)
 @ Forward Current = 700mA (For 365nm)

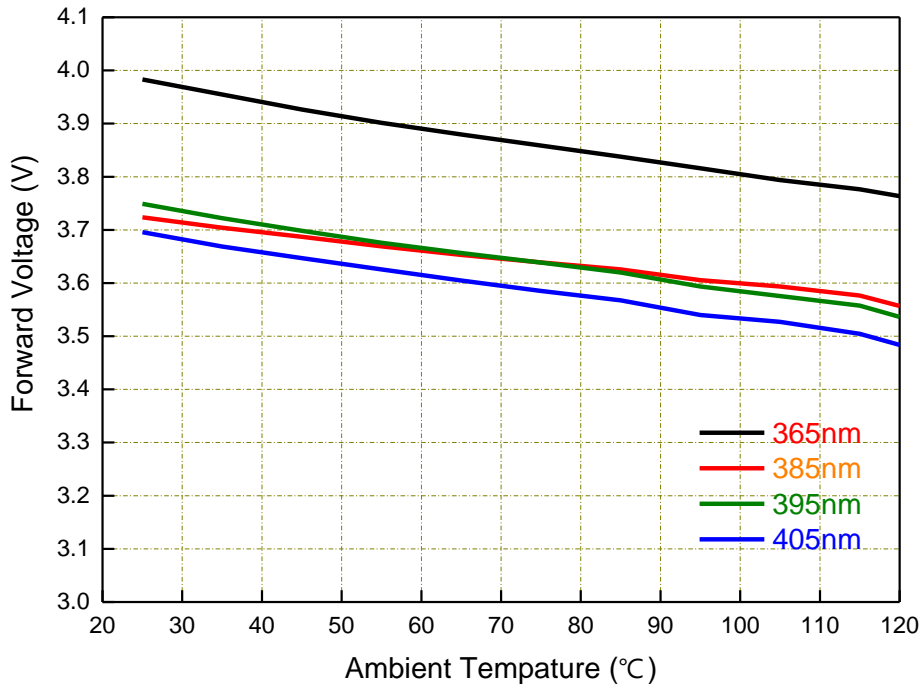

Derating Curve

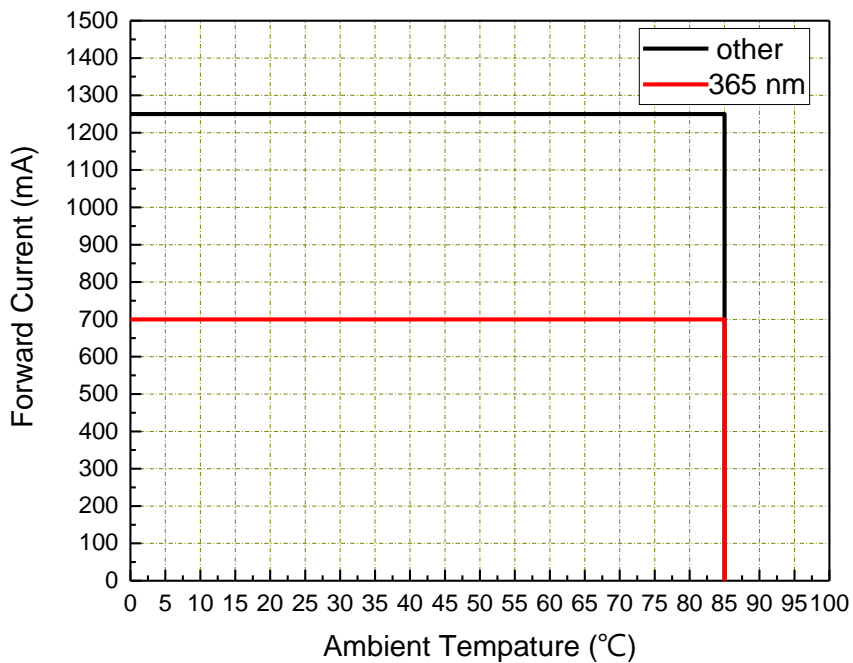

Typical Radiation Patterns

Typical Diagram Characteristics of Radiation for ELUA3535NU3

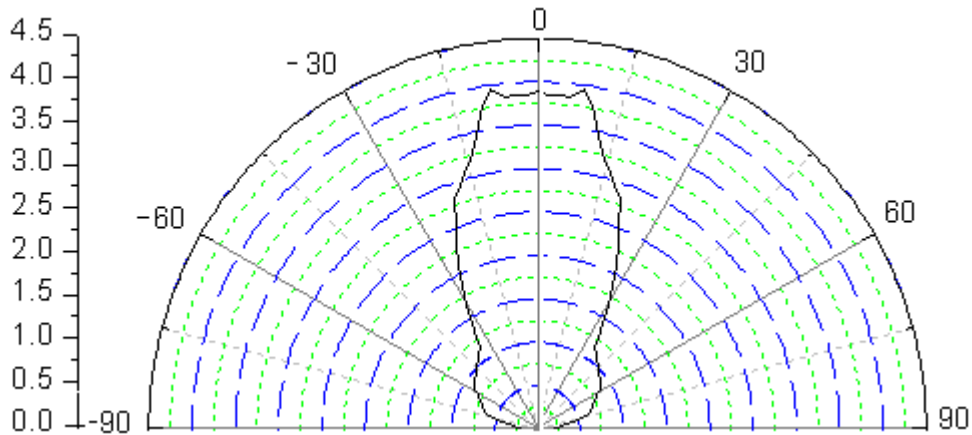

Notes:

1. $2\theta_{1/2}$ is the off axis angle from lamp centerline where the luminous intensity is 1/2 of the peak value.
2. View angle tolerance is $\pm 5^\circ$.

Emitter Tape Packaging

Carrier Tape Dimensions as the following:

Reel: 400pcs

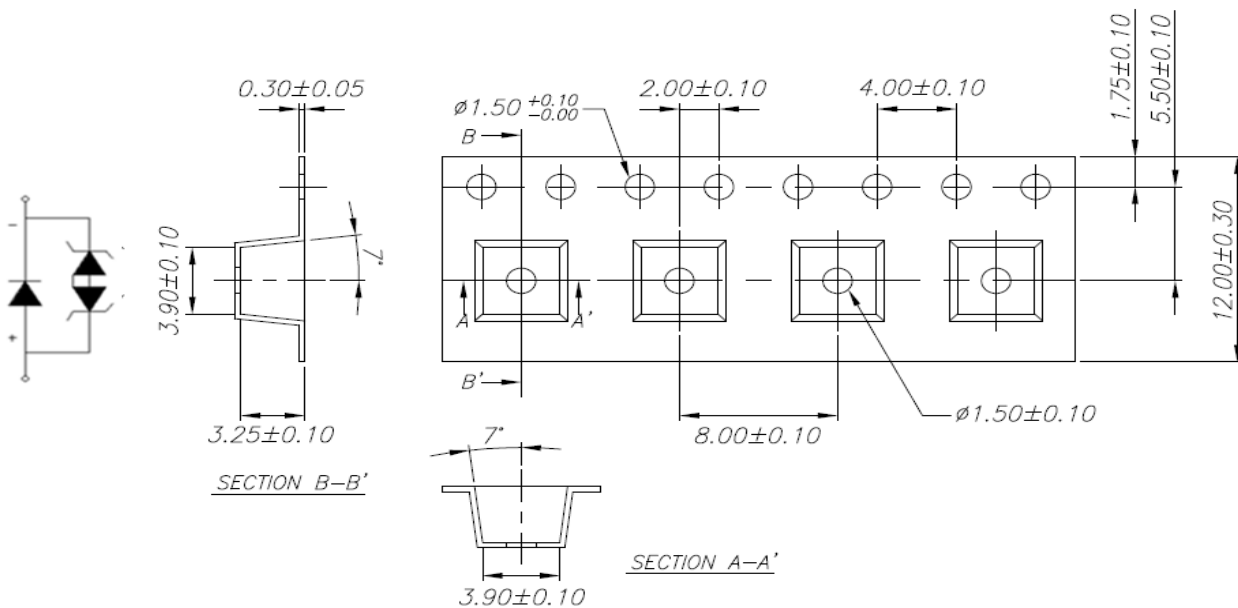

Notes:

1. Tolerance unless mentioned is $\pm 0.1\text{mm}$; Unit = mm
2. Packing amount is 100/200/300/400 pcs per reel

Moisture Resistant Packaging

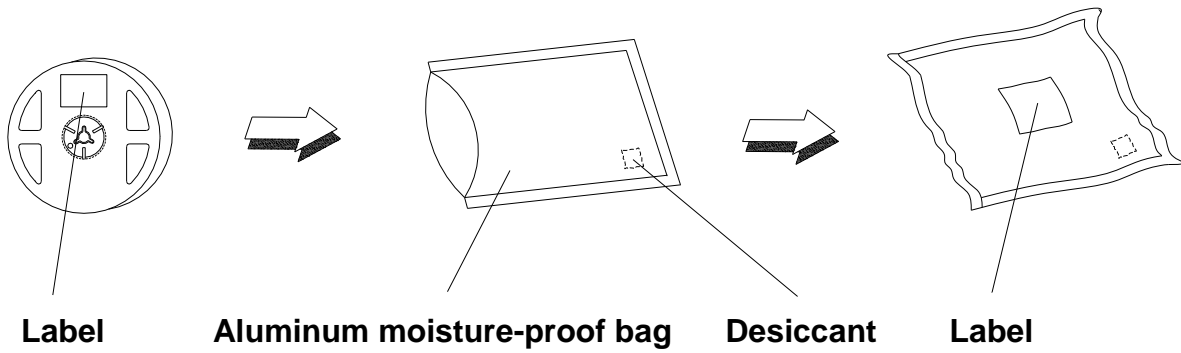

Emitter Reel Packaging

Reel Dimensions

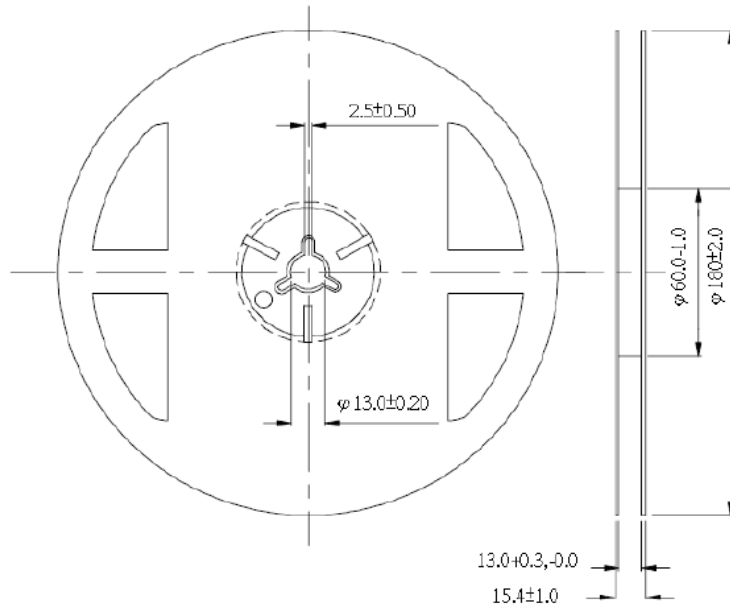

Notes:

1. Dimensions are in millimeters.
2. Tolerances unless mentioned are ± 0.1 mm.

Label Explanation

CPN: Customer Specification (when required)

P/N : Everlight Production Number

QTY: Packing Quantity

CAT: Luminous Flux (Brightness) Bin

HUE: Color Bin

REF: Forward Voltage Bin

LOT No: Lot Number

MADE IN TAIWAN: Production Place

Product Labeling

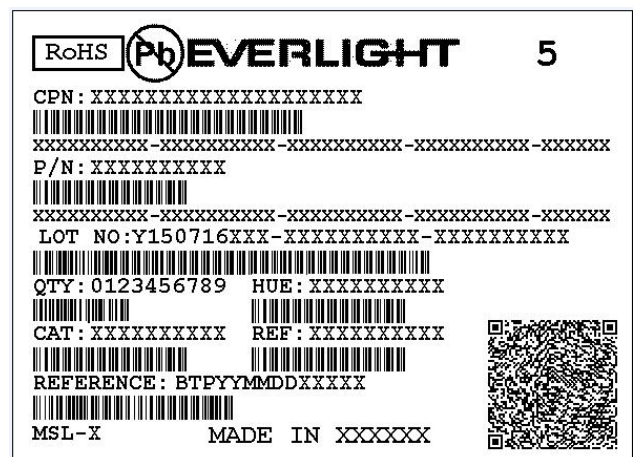

Storage Conditions

- Before the package is opened :The LEDs should be stored at 30°C or less and 85%RH or less after being shipped from Everlight and the storage life limits are 1 year. The LEDs can be stored up to 3 years if in a sealed container with a nitrogen atmosphere and moisture absorbent material.
- After opening the package: The LED's floor life is 168 hours under 30°C or less and 60% RH or less. If unused LEDs remain, it should be stored in moisture proof packages.
- If the moisture absorbent material (silica gel) has faded away or the LEDs have exceeded the storage time, baking treatment should be performed using the following conditions. Baking treatment: 60±5°C for 24 hours.

DISCLAIMER

- EVERLIGHT reserves the right(s) on the adjustment of product material mix for the specification.
- The product meets EVERLIGHT published specification for a period of twelve (12) months from date of shipment.
- The graphs shown in this datasheet are representing typical data only and do not show guaranteed values.
- When using this product, please observe the absolute maximum ratings and the instructions for using outlined in these specification sheets. EVERLIGHT assumes no responsibility for any damage resulting from the use of the product which does not comply with the absolute maximum ratings and the instructions included in these specification sheets.
- These specification sheets include materials protected under copyright of EVERLIGHT. Reproduction in any form is prohibited without obtaining EVERLIGHT's prior consent.
- This product is not intended to be used for military, aircraft, automotive, medical, life sustaining or life saving applications or any other application which can result in human injury or death. Please contact authorized EVERLIGHT sales agent for special application request.
- **Do not soaked in organic material, avoid peeling off the film on the reflector.**
- **Temperature cannot exceed 300 degrees Celsius, avoid peeling off the film on the reflector.**

单击下面可查看定价，库存，交付和生命周期等信息

[>>Everlight \(亿光\)](#)