

Technical Data Sheet

Top View LEDs

67-11-BHC-F0Q2S1M0E-2T8-AM



Feature

- RoHS compliant.
- P-LCC-2 package.
- Colorless clear resin.
- Wide viewing angle 120°.
- Inner reflector and white package.
- Brightness: 90 to 224 mcd at 20mA.
- Qualification according to AEC-Q101.
- Precondition: Bases on JEDEC J-STD 020 Level 2.
- Useable in severe lead free processes with automotive reflow profile (IR reflow or wave soldering)

Applications

- Automotive backlighting or indicator: Dashboard, switch, audio and video equipments...etc.
- Backlight: LCD, switches, symbol, mobile phone and illuminated advertising.
- Display for indoor and outdoor application.
- Ideal for coupling into light guides.
- Substitution of traditional light.
- Optical indicator.
- General applications.

Device Selection Guide

Chip	Emitted Color	Resin Color
Material		
InGaN	Blue	Water Clear

Technical Data Sheet**Top View LEDs****67-11-BHC-F0Q2S1M0E-2T8-AM****Absolute Maximum Ratings (Ta=25°C)**

Parameter	Symbol	Rating	Unit
Reverse Voltage	V_R	5	V
Forward Current	I_F	25	mA
Peak Forward Current (Duty 1/10 @1KHz)	I_{FP}	100	mA
Power Dissipation	P_d	95	mW
Junction Temperature	T_j	115	°C
Operating Temperature	T_{opr}	-40 ~ +100	°C
Storage Temperature	T_{stg}	-40 ~ +110	°C
Thermal Resistance	$R_{th\ J-A}$	500	K/W
	$R_{th\ J-S}$	300	K/W
ESD (Classification acc. AEC Q101)	ESD_{HBM}	2000	V
	ESD_{MM}	200	V
Soldering Temperature	T_{sol}	Reflow Soldering : 260 °C for 30 sec. Hand Soldering : 350 °C for 3 sec.	

Technical Data Sheet**Top View LEDs****67-11-BHC-F0Q2S1M0E-2T8-AM****Electro-Optical Characteristics (Ta=25°C)**

Parameter	Symbol	Min.	Typ.	Max.	Unit	Condition
Luminous Intensity	I_v	90	---	224	mcd	$I_F = 20\text{mA}$
Viewing Angle	$2\theta_{1/2}$	---	120	---	deg	$I_F = 20\text{mA}$
Peak Wavelength	λ_p	---	468	---	nm	$I_F = 20\text{mA}$
Dominant Wavelength	λ_d	464	---	472	nm	$I_F = 20\text{mA}$
Spectrum Radiation Bandwidth	$\Delta\lambda$	---	25	---	nm	$I_F = 20\text{mA}$
Forward Voltage	V_F	2.75	---	3.95	V	$I_F = 20\text{mA}$
Reverse Current	I_R	---	---	50	μA	$V_R = 5\text{V}$
Temperature coefficient of λ_p	TC_{λ_p}	---	0.11	---	nm/K	$I_F = 20\text{mA}$
Temperature coefficient of λ_d	TC_{λ_d}	---	0.04	---	nm/K	$I_F = 20\text{mA}$
Temperature coefficient of V_F	TC_V	---	-1.7	---	mV/K	$I_F = 20\text{mA}$

Note:

1. Tolerance of Luminous Intensity: $\pm 11\%$
2. Tolerance of Dominant Wavelength: $\pm 1\text{nm}$
3. Tolerance of Forward Voltage: $\pm 0.1\text{V}$

Technical Data Sheet**Top View LEDs****67-11-BHC-F0Q2S1M0E-2T8-AM****Bin Range of Luminous Intensity**

Bin Code	Min.	Max.	Unit	Condition
Q2	90	112	mcd	$I_F = 20\text{mA}$
R1	112	140		
R2	140	180		
S1	180	224		

Note:

Tolerance of Luminous Intensity: $\pm 11\%$ **Bin Range of Dominant Wavelength**

Bin Code	Min.	Max.	Unit	Condition
AA1	464	466	nm	$I_F = 20\text{mA}$
AA2	466	468		
AA3	468	470		
AA4	470	472		

Note:

Tolerance of Dominant Wavelength: $\pm 1\text{nm}$

Technical Data Sheet

Top View LEDs

67-11-BHC-F0Q2S1M0E-2T8-AM

Typical Electro-Optical Characteristics Curves

Typical Curve of Spectral Distribution

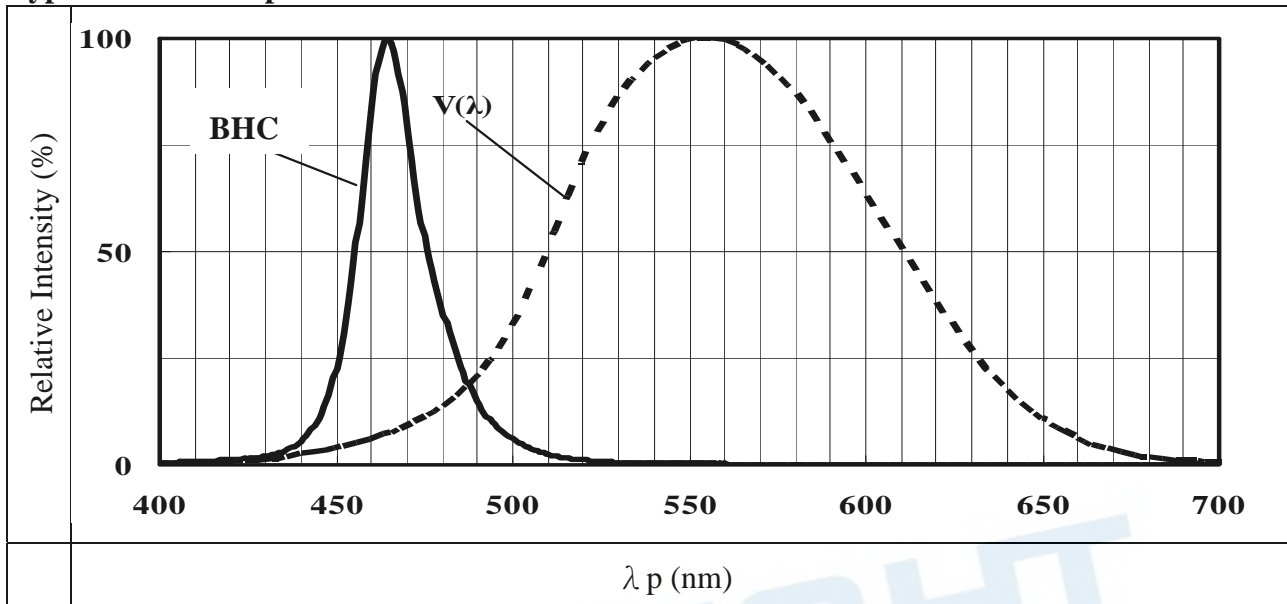

Note: $V(\lambda)$ =Standard eye response curve; $I_F=20\text{mA}$

Diagram Characteristics of Radiation

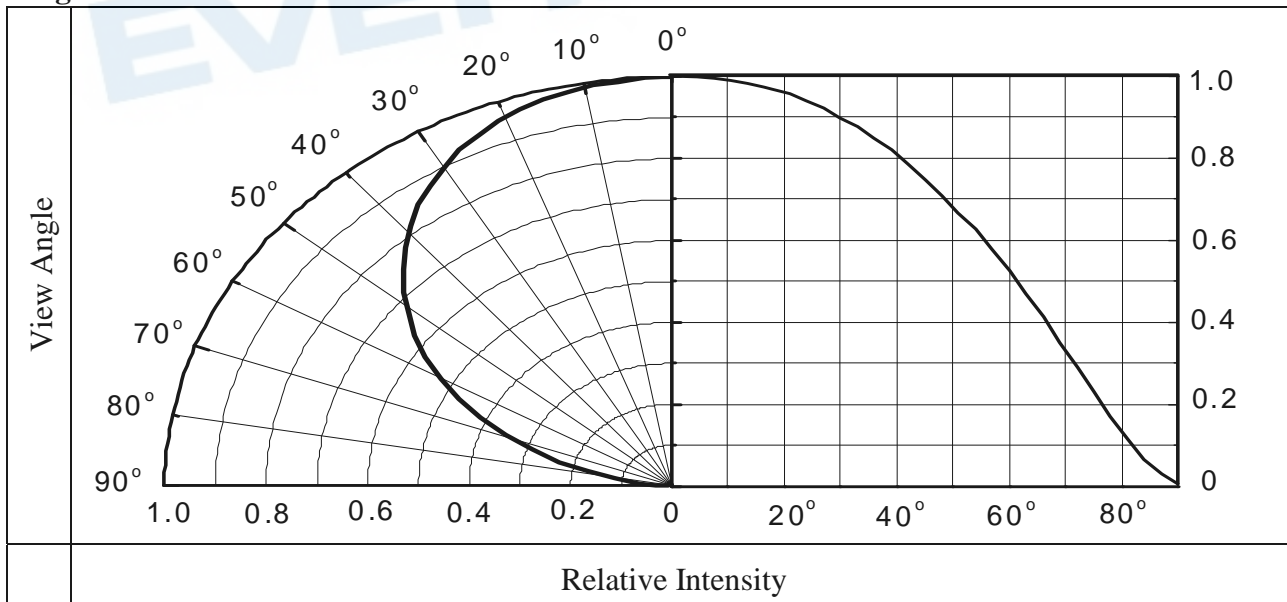

Technical Data Sheet

Top View LEDs

67-11-BHC-F0Q2S1M0E-2T8-AM

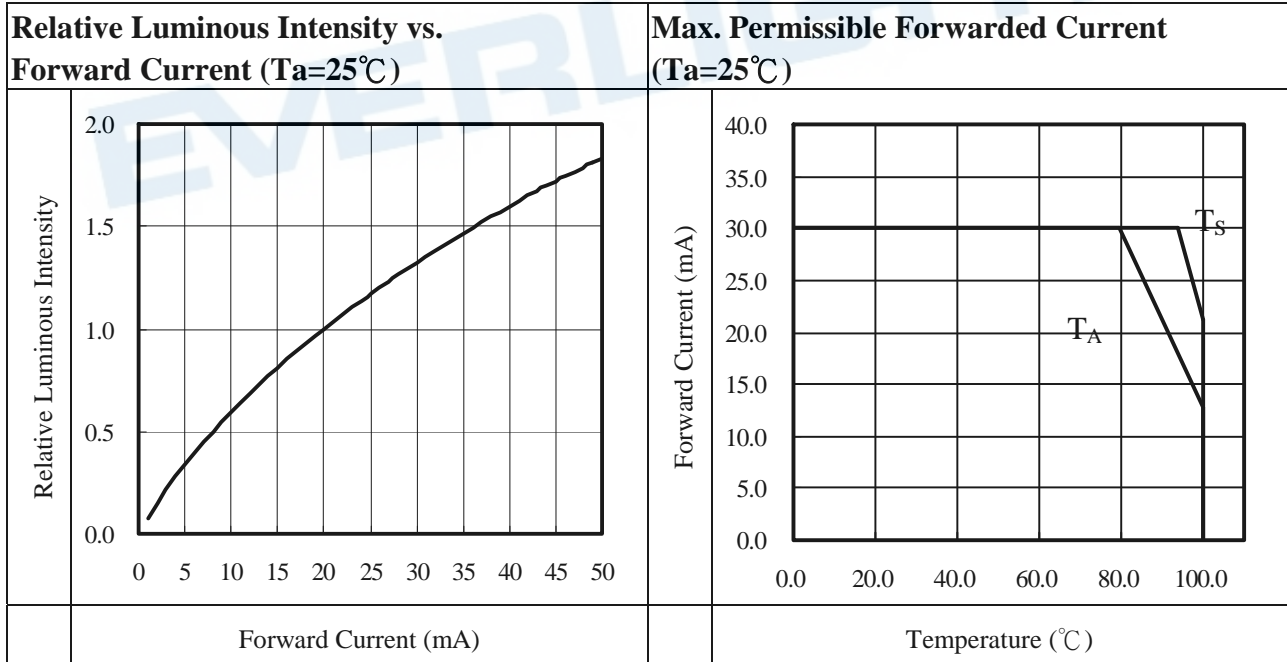
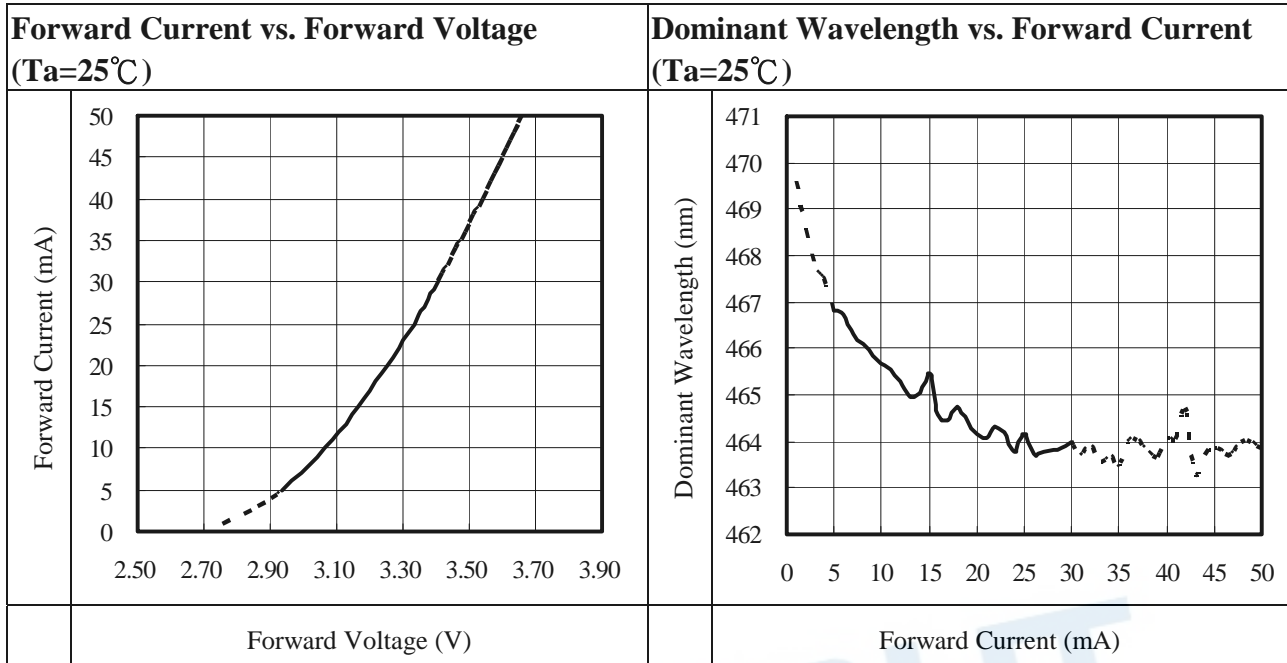

Technical Data Sheet

Top View LEDs

67-11-BHC-F0Q2S1M0E-2T8-AM

Relative Luminous Intensity vs. Junction Temperature		Relative Forward Voltage vs. Junction Temperature	
Relative Luminous Intensity		Relative Forward Voltage	
	Junction Temperature (°C)		Junction Temperature (°C)
Note: $f(T_j) = I_v / I_v(25^\circ\text{C}); I_F = 20\text{mA}$		Note: $\Delta V_F = V_F - V_F(25^\circ\text{C}) = f(T_j); I_F = 20\text{mA}$	

Technical Data Sheet

Top View LEDs

67-11-BHC-F0Q2S1M0E-2T8-AM

Package Dimension

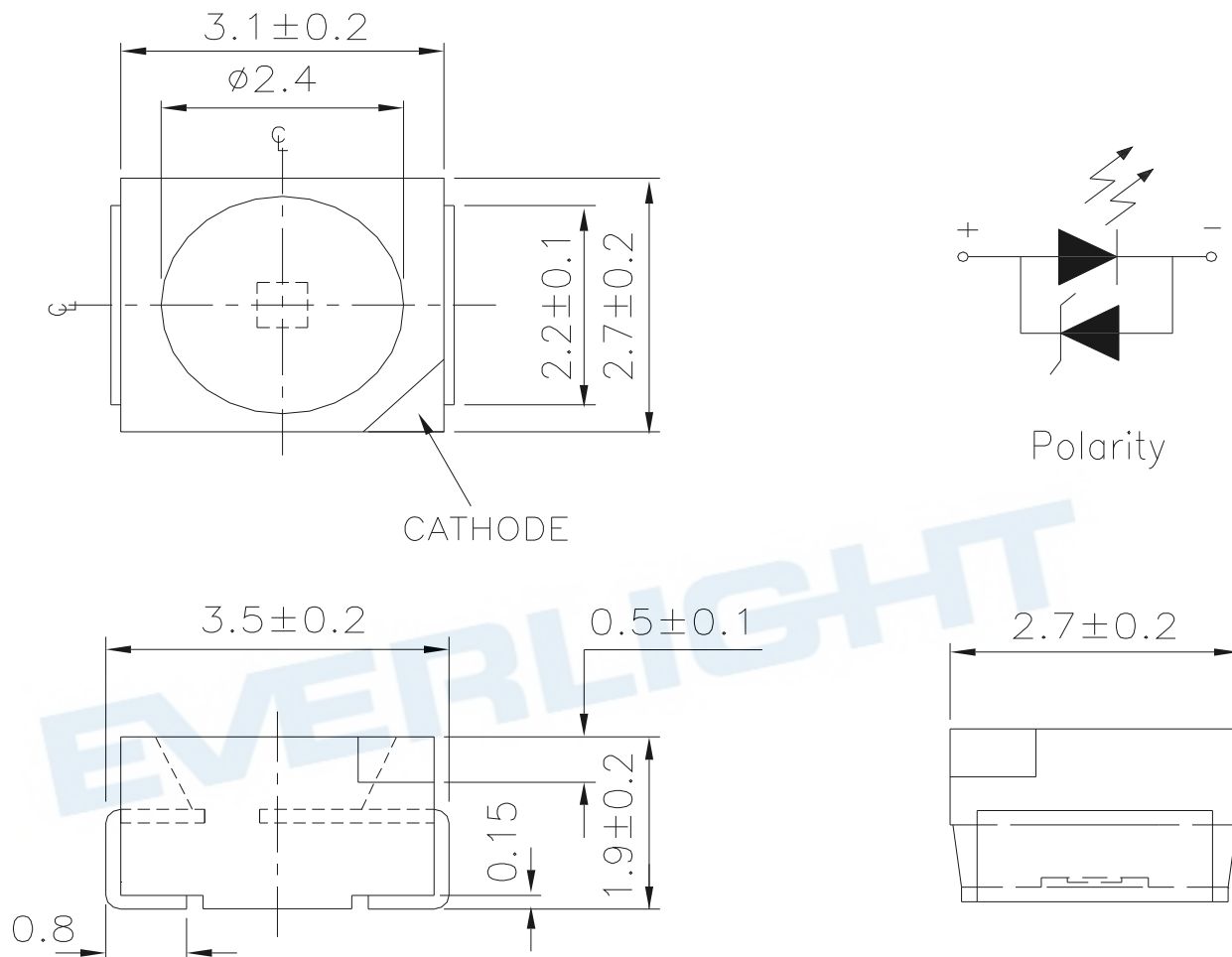

Note: Tolerances unless mentioned ± 0.1 mm. Unit = mm

Technical Data Sheet

Top View LEDs

67-11-BHC-F0Q2S1M0E-2T8-AM

Moisture Resistant Packing Materials

Label Explanation

- CPN: Customer's Product Number
- P/N: Product Number
- QTY: Packing Quantity
- CAT: Luminous Intensity Rank
- HUE: Dom. Wavelength Rank
- REF: Forward Voltage Rank
- LOT No: Lot Number

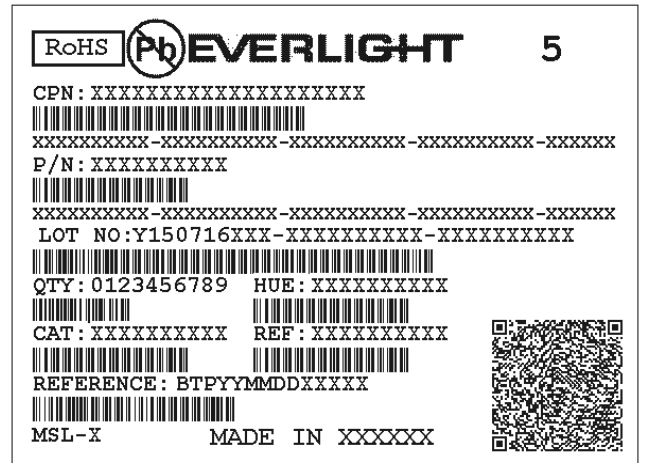

Reel Dimensions

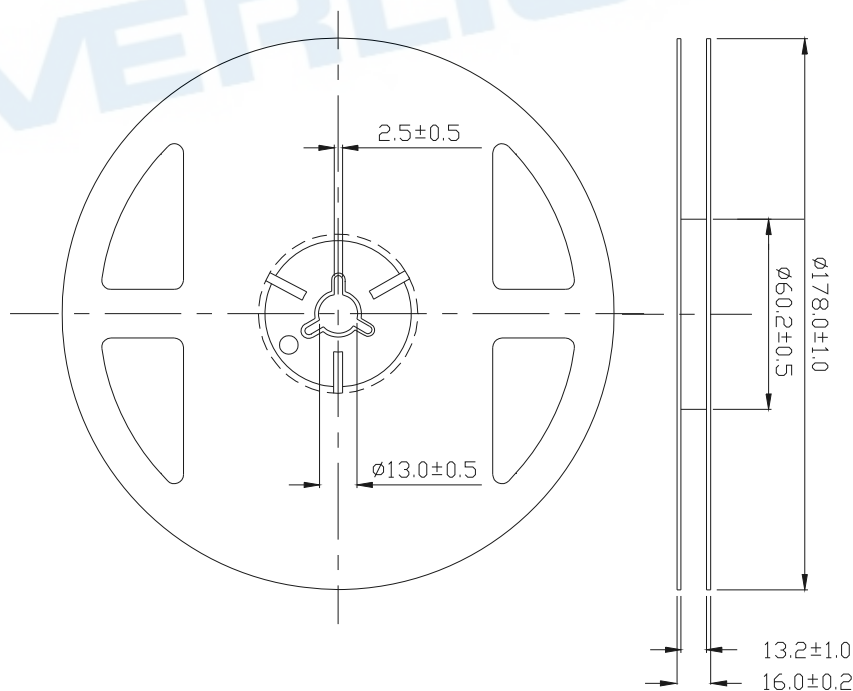

Note: Unit = mm

Technical Data Sheet

Top View LEDs

67-11-BHC-F0Q2S1M0E-2T8-AM

Carrier Tape Dimensions: Loaded Quantity 2000 pcs Per Reel

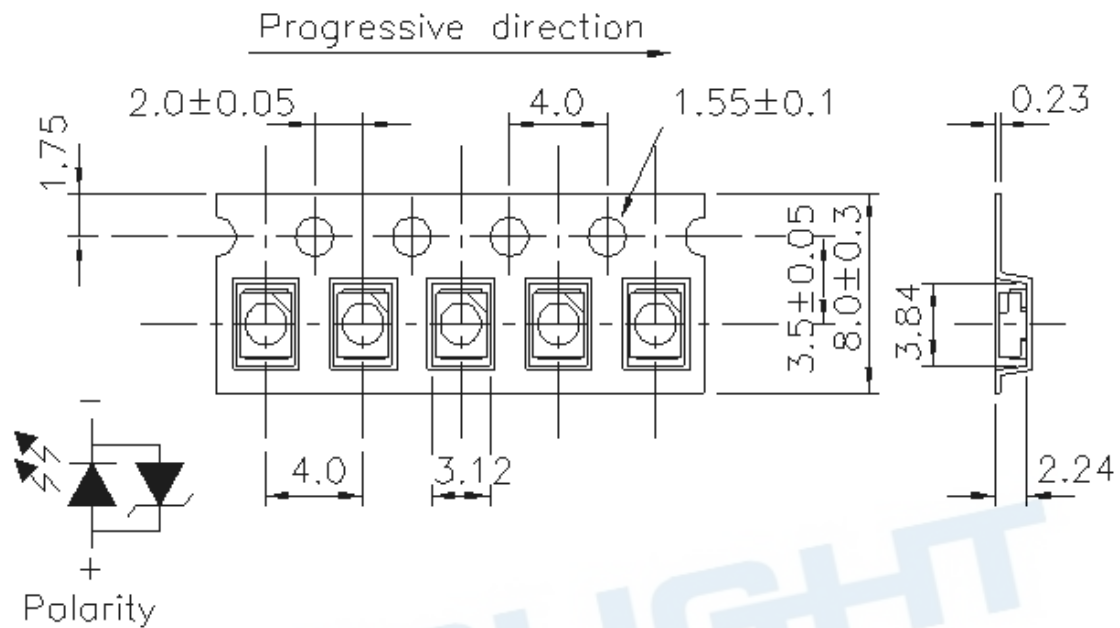

Note: Tolerances unless mentioned ± 0.1 mm. Unit = mm

Moisture Resistant Packing Process

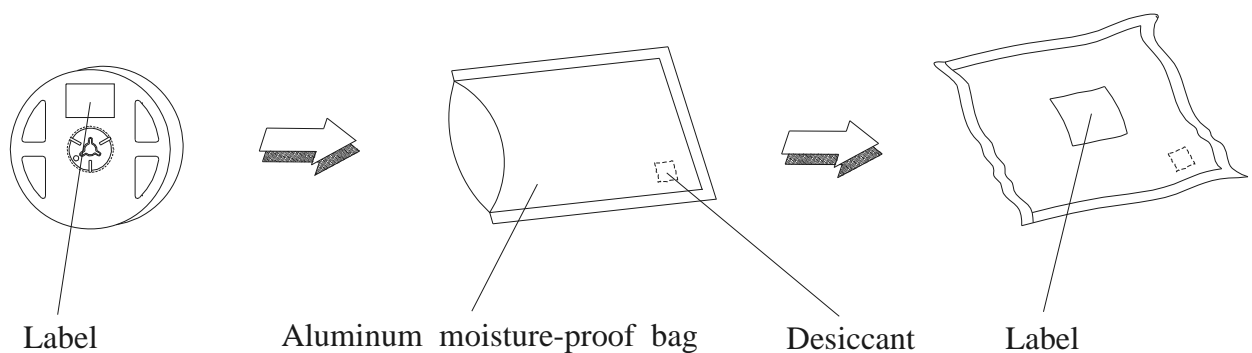

Technical Data Sheet

Top View LEDs

67-11-BHC-F0Q2S1M0E-2T8-AM

Precautions for Use

1. Soldering Condition

1.1 (A) Maximum Body Case Temperature Profile for evaluation of Reflow Profile

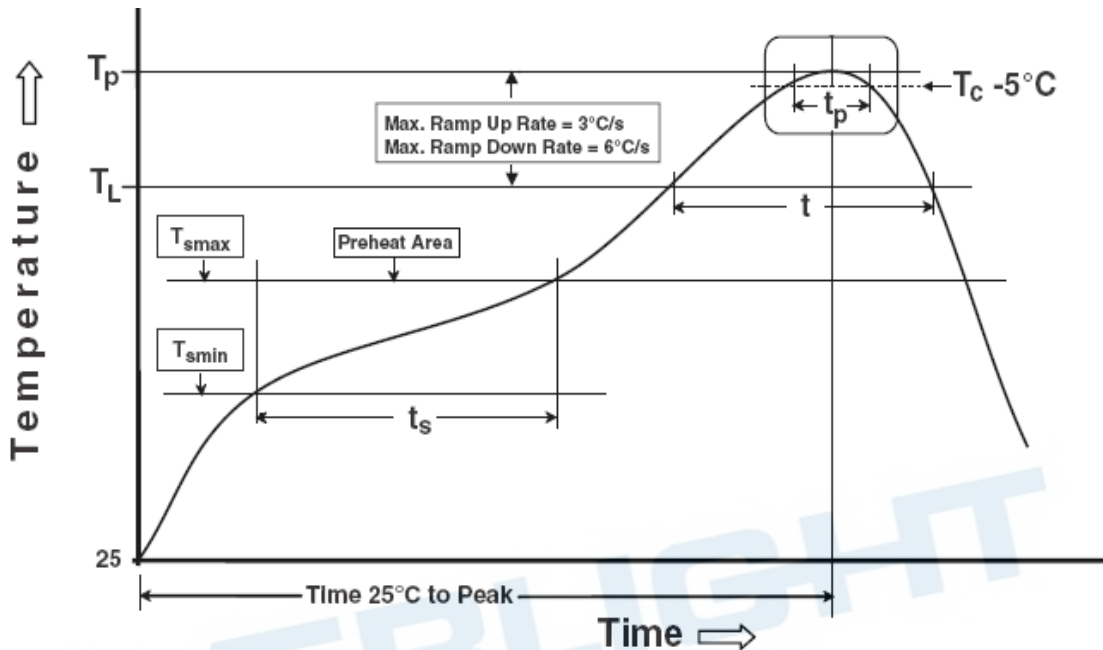

Note:

Preheat

Temperature min (T_{smin})

Temperature max (T_{smax})

Time (T_{smin} to T_{smax}) (t_s)

Average ramp-up rate (T_{smax} to T_p)

Other

Liquidus Temperature (T_L)

Time above Liquidus Temperature (t_L)

Peak Temperature (T_p)

Time within 5 °C of Actual Peak Temperature: $T_p - 5^\circ\text{C}$

Ramp- Down Rate from Peak Temperature

Time 25°C to peak temperature

Reflow times

Reference: IPC/JEDEC J-STD-020D

150 °C

200°C

60-120 seconds

3 °C/second max

217 °C

60-150 sec

260°C

30 s

6°C /second max.

8 minutes max.

3 times

All parameters are maximum body case temperature values and cannot be considered as a soldering profile. The body case temperature was measured by soldering a thermal couple to the soldering point of LEDs.

Technical Data Sheet

Top View LEDs

67-11-BHC-F0Q2S1M0E-2T8-AM

(B) Recommend soldering pad

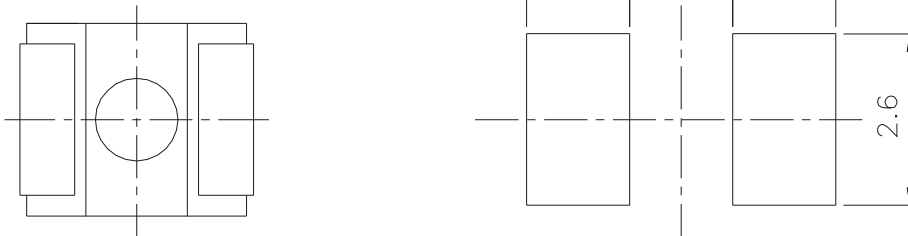

Note: Tolerances unless mentioned $\pm 0.1\text{mm}$. Unit = mm

2. Current limiting

A resistor should be used to limit current spikes that can be caused by voltage fluctuations. Otherwise damage could occur.

3. Storage

- 3.1 Moisture proof bag should only be opened immediately prior to usage.
- 3.2 Environment should be less than 30°C and 60% RH when moisture proof bag is opened.
- 3.3 After opening the package MSL Conditions stated on page 1 of this spec should not be exceeded.
- 3.4 If the moisture sensitivity card indicates higher than acceptable moisture, the component should be baked at min. $60\text{deg} \pm 5\text{deg}$ for 24 hours.

4. Iron Soldering

Hand soldering is not recommended for regular production. These guidelines are for rework only. Soldering iron tip should contact each terminal no more than 3 sec at 350°C , using soldering iron with nominal power less than 25W. Allow min. 2 sec. between soldering intervals.

5. Usage

Do not exceed the values given in this specification.

单击下面可查看定价，库存，交付和生命周期等信息

[>>Everlight \(亿光\)](#)