

### EL 3535E

### CH3535E-UR3501L-AM

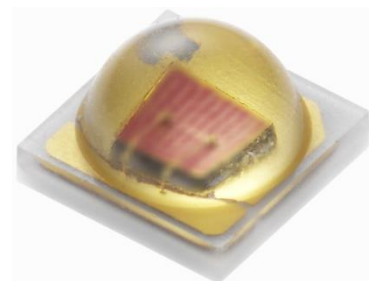

#### Features

- Package: SMD ceramic package
- Color : Red
- Typical luminous flux: 75 lm @ 350mA
- Viewing angle: 120°
- ESD: up to 8KV
- MSL : 2
- Qualifications: According to AEC-Q102
- The product itself will remain within RoHS compliant version.
- Compliance with EU REACH.
- Compliance Halogen Free. (Br<900ppm,Cl<900ppm,Br+Cl<1500ppm)
- Sulfur robustness

#### Applications

- Automotive exterior lighting
- Tail light
- Stop lamp

# Contents

<b>1.Characteristics .....</b>	<b>3</b>
<b>2.Absolute Maximum Ratings .....</b>	<b>4</b>
<b>3.Characteristics Graph .....</b>	<b>5</b>
<b>4.Binning Information .....</b>	<b>10</b>
<b>5.Part Number .....</b>	<b>13</b>
<b>6.Ordering Information .....</b>	<b>14</b>
<b>7.Mechanical Dimension .....</b>	<b>15</b>
<b>8.Recommended Soldering Pad .....</b>	<b>16</b>
<b>9.Reflow Soldering Profile .....</b>	<b>16</b>
<b>10.Packaging Information .....</b>	<b>17</b>
<b>11.Precaution for Use .....</b>	<b>19</b>

## 1. Characteristics

Parameter	Symbol	Min.	Typ.	Max.	Unit	Condition	
Forward Current	$I_F$	50	350	700	mA	---	
Luminous Flux <sup>[1][2]</sup>	$I_v$	60	75	100	lm	$I_F=350mA$	
Forward Voltage <sup>[3][4]</sup>	$V_F$	1.75	2.22	2.75	V	$I_F=350mA$	
Viewing Angle	$\phi$	---	120	---	deg	$I_F=350mA$	
Dominant Wavelength <sup>[5]</sup>	$\lambda_d$	615	619	627	nm	$I_F=350mA$	
Thermal Resistance (Junction to Solder)	Real	$R_{th JS real}$	---	7.4	10.3	K/W	$I_F=350mA$
	Electrical	$R_{th JS el}$	---	4.5	6.3		

### Notes:

1. Luminous Flux measurement tolerance:  $\pm 8\%$ .
2. The data of Luminous Flux measured at thermal pad=25°C
3. Forward voltage measurement tolerance:  $\pm 0.05V$
4. The  $V_F$  range shown in the table above indicates 99% output.
5. Tolerance of Dominant Wavelength :  $\pm 1nm$ .

## 2. Absolute Maximum Ratings

Parameter	Symbol	Ratings	Unit
Power Dissipation	$P_d$	1925	mW
Forward Current	$I_F$	700	mA
Surge Current ( $t \leq 10 \mu s$ ; $D=0.005$ ; $T_s=25 \text{ }^\circ\text{C}$ )	$I_{FM}$	2500	mA
Reverse Voltage	$V_R$	Not designed for reverse operation	V
Junction Temperature	$T_J$	150	$^\circ\text{C}$
Operating Temperature	$T_{opr}$	-40 ~ +125	$^\circ\text{C}$
Storage Temperature	$T_{stg}$	-40 ~ +125	$^\circ\text{C}$
ESD Sensitivity ( $R=1.5k\Omega$ , $C=100pF$ )	$ESD_{HBM}$	8	kV
Soldering Temperature	Reflow	260 $^\circ\text{C}$ for 30sec	$^\circ\text{C}$

### 3. Characteristics Graph

**Wavelength Characteristics Relative Spectral Distribution**  
@ Ts = 25°C If=350mA

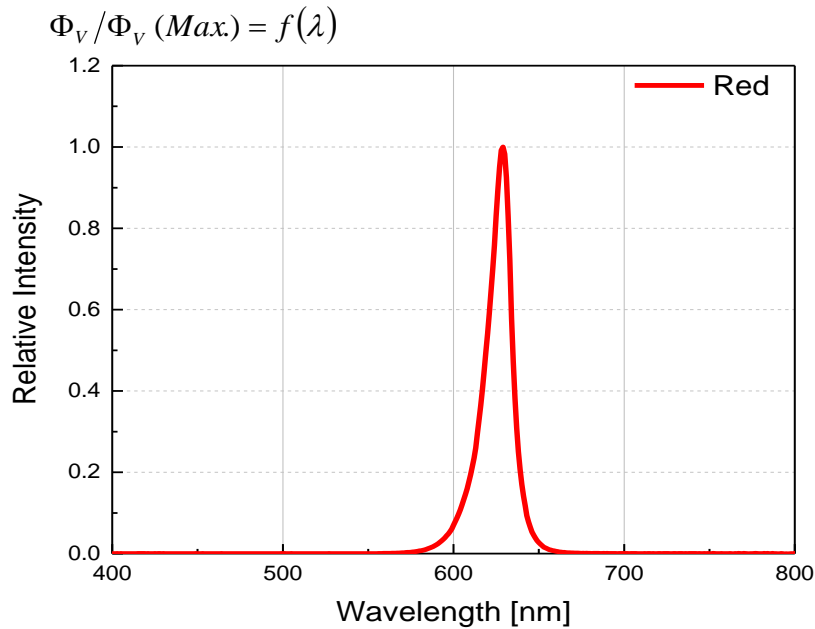

**Typical Diagram Characteristics of Radiation**

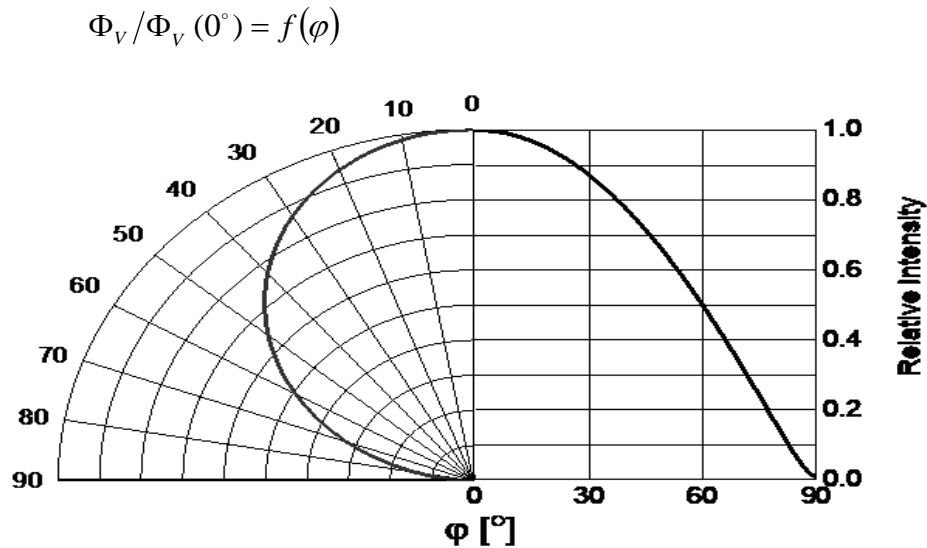

**Notes:**

1.  $\varphi$  is the off axis angle from lamp centerline where the luminous intensity is 1/2 of the peak value.
2. View angle tolerance is  $\pm 5^\circ$ .

**Forward Current vs. Forward Voltage**  
@ Ts = 25°C

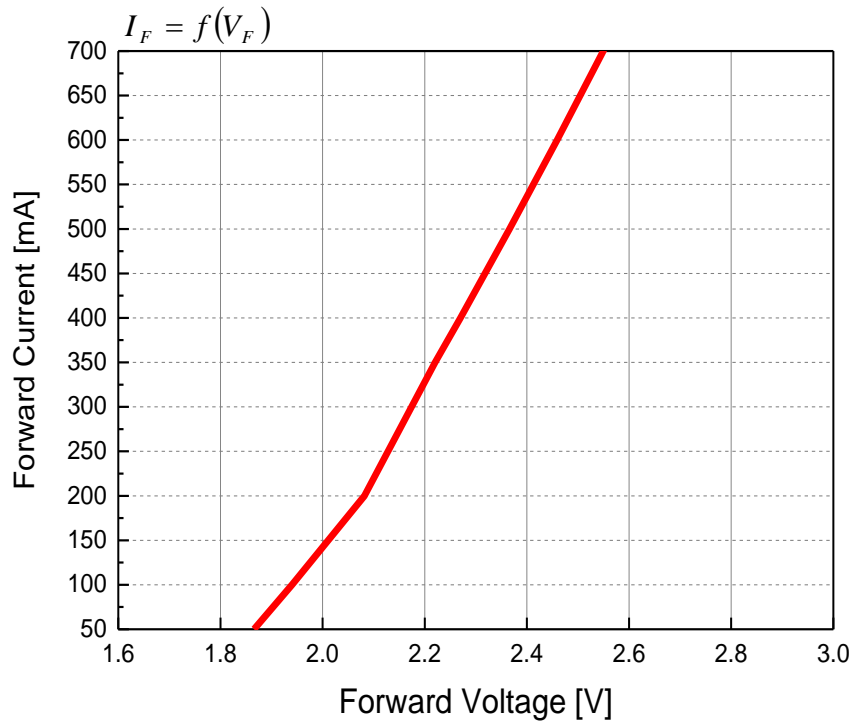

**Relative Luminous Flux vs. Forward Current**  
@ Ts = 25°C

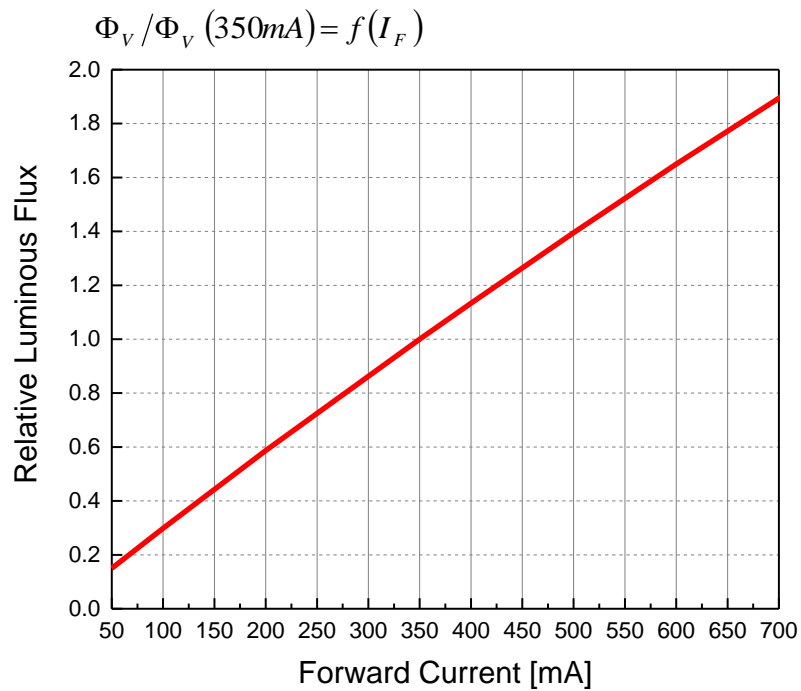

**Dominant Wavelength vs. Forward Current**  
@  $T_s = 25^\circ C$

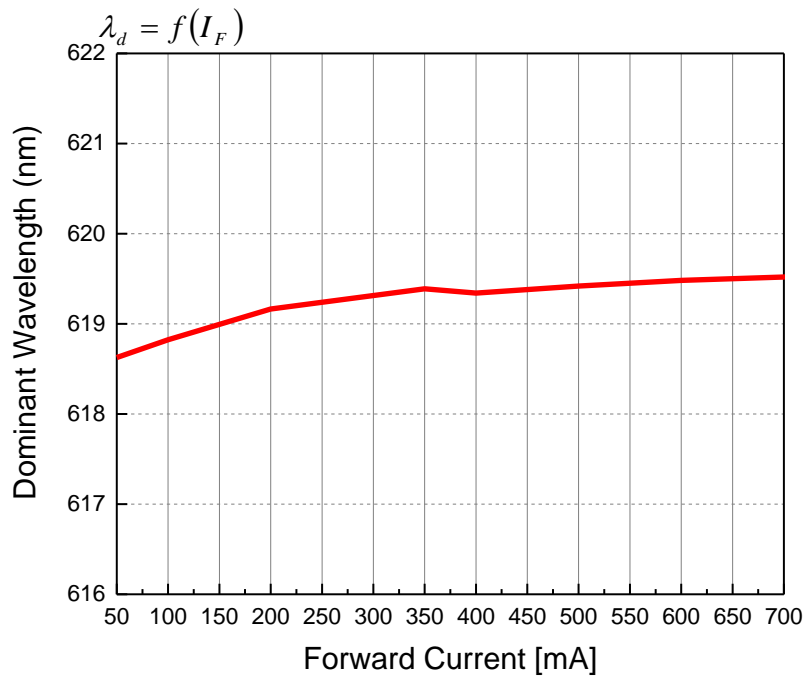

**Relative Forward Voltage vs. Junction Temperature**  
@  $I_F = 350mA$

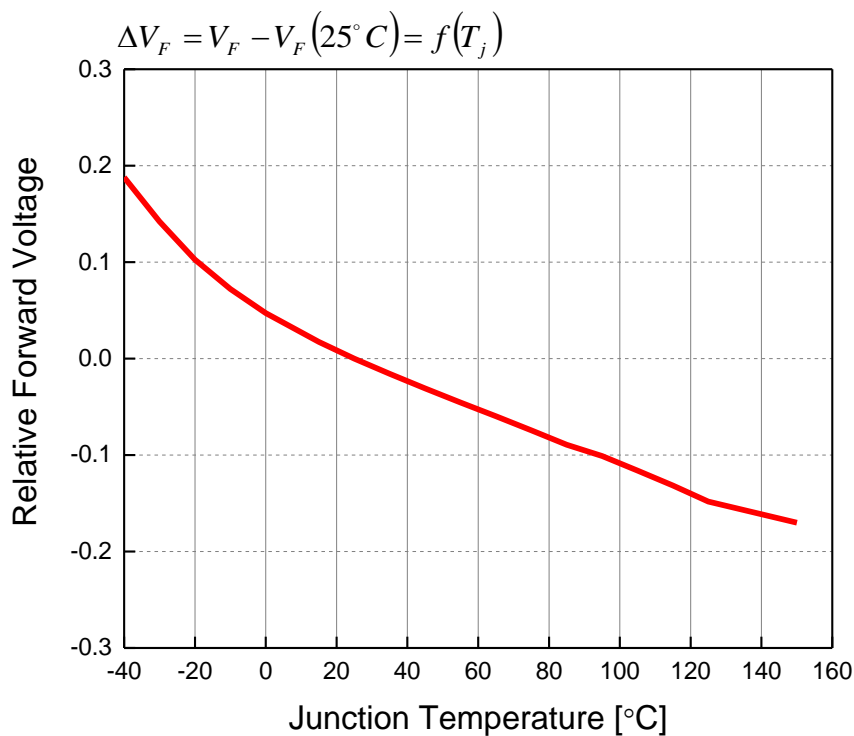

### Relative Luminous Flux vs. Junction Temperature

@ I<sub>F</sub>=350mA

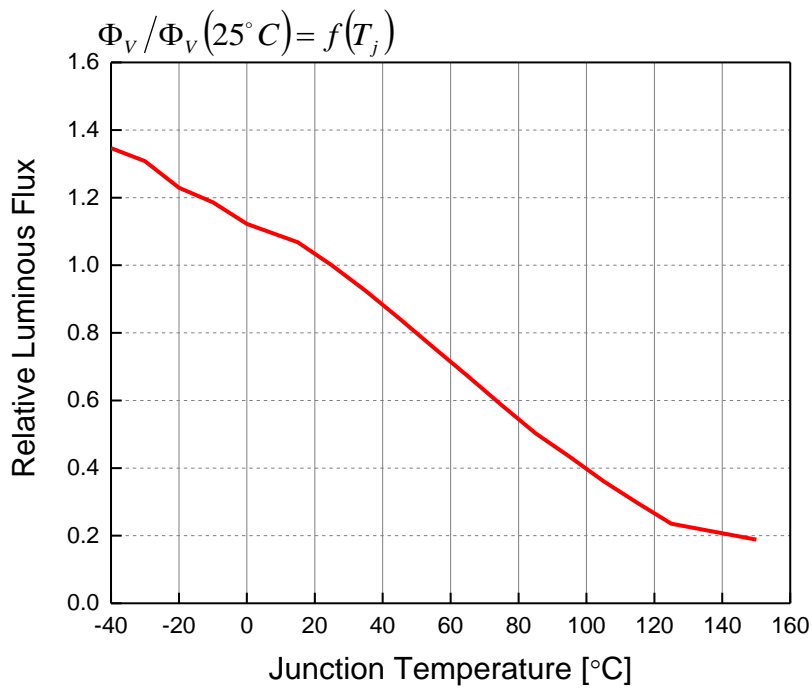

### Dominant Wavelength vs. Junction Temperature

@ I<sub>F</sub>=350mA

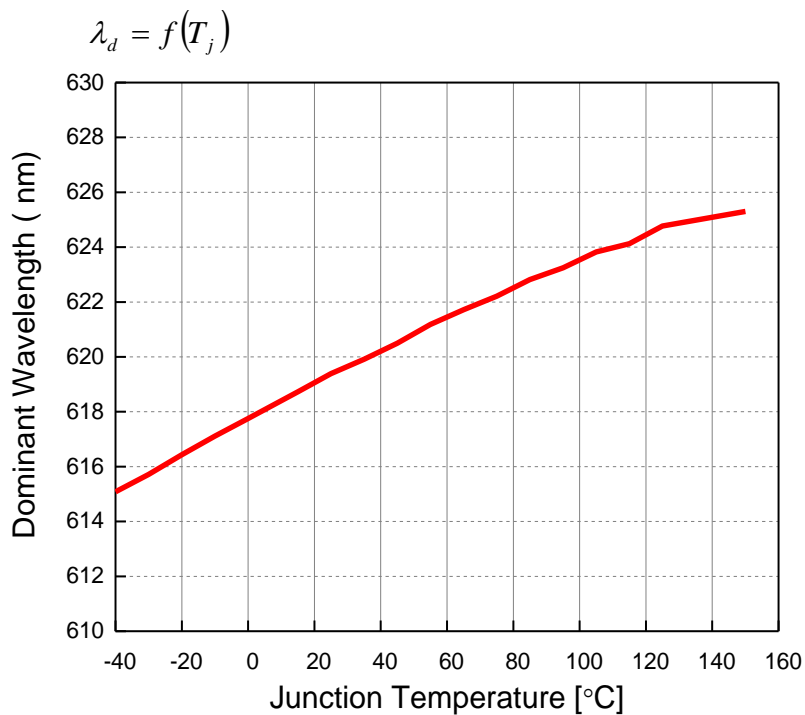



### Forward Current Derating Curve

$$I_F = f(T_s)$$

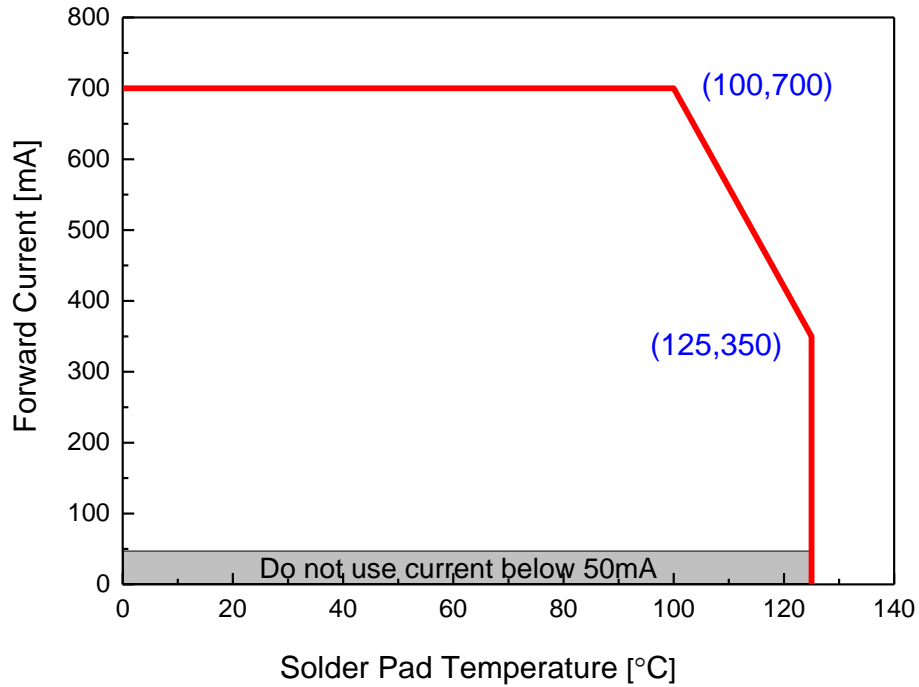

### Permissible Pulse Handling Capability

D=Duty cycle ,  $T_s = 25^\circ\text{C}$

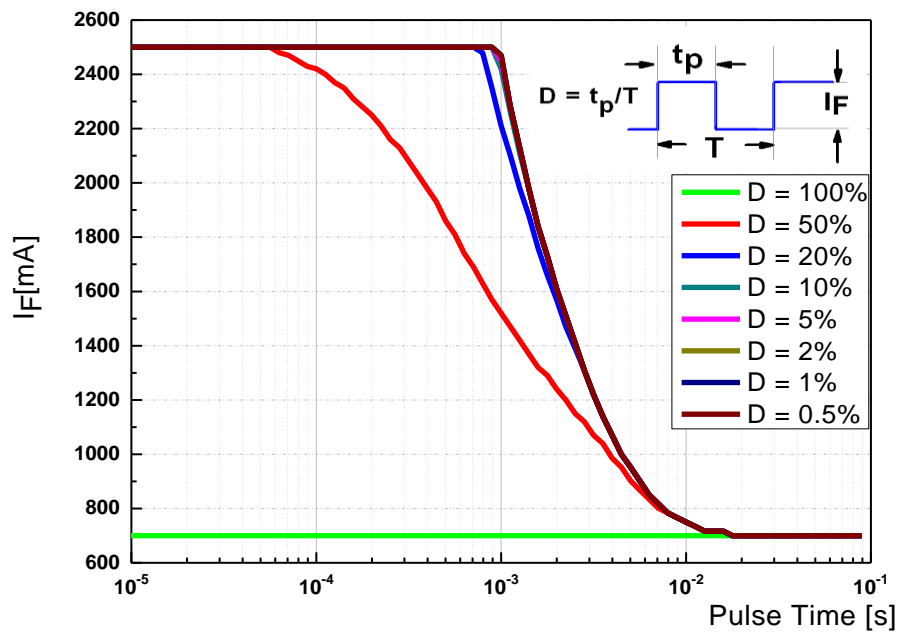

## 4. Binning Information

### Luminous Flux Bins

Group	Bin	Minimum Photometric Flux (lm)	Maximum Photometric Flux (lm)
E	1	4	5
	2	5	6
	3	6	8
	4	8	10
	5	10	13
	6	13	17
	7	17	20
	8	20	23
	9	23	27
F	1	27	33
	2	33	39
	3	39	45
	4	45	52
	5	52	60
	6	60	70
	7	70	80
	8	80	90
	9	90	100

Group	Bin	Minimum Photometric Flux (lm)	Maximum Photometric Flux (lm)
J	1	100	110
	2	110	120
	3	120	130
	4	130	140
	5	140	150
	6	150	160
	7	160	180
	8	180	200
	9	200	225
K	1	225	250
	2	250	275
	3	275	300
	4	300	325
	5	325	350
	6	350	375
	7	375	400
	8	400	425
	9	425	450

#### Notes:

1. Luminous flux measurement tolerance:  $\pm 8\%$ .

### Wavelength Bin Structure

Color Bin Structure Bin	Minimum Dominant Wavelength [nm]	Maximum Dominant Wavelength [nm]
4751	447	451
5155	451	455
5559	455	459
5963	459	463
6367	463	467
6771	467	471
7175	471	475
1015	510	515
1520	515	520
2025	520	525
2530	525	530
3035	530	535
5861	558	561
6164	561	564
6467	564	567
6770	567	570
7073	570	573
7376	573	576
7679	576	579
7982	579	582
8285	582	585
8588	585	588
8891	588	591
9194	591	594
9497	594	597
9700	597	600
0003	600	603
0306	603	606
0609	606	609
0912	609	612
1215	612	615
1518	615	618
1821	618	621
2124	621	624
2427	624	627
2730	627	630
3033	630	633
3336	633	636
3639	636	639

**Notes:**

1. Dominant wavelength measurement tolerance:  $\pm 1$ nm.

### Forward Voltage Bins

Bin	Minimum Forward Voltage [V]	Maximum Forward Voltage [V]
1012	1.00	1.25
1215	1.25	1.75
1517	1.50	1.75
1720	1.75	2.00
2022	2.00	2.25
2225	2.25	2.50
2527	2.50	2.75
2730	2.75	3.00
3032	3.00	3.25
3235	3.25	3.50
3537	3.50	3.75
3740	3.75	4.00
4042	4.00	4.25
4245	4.25	4.50
4547	4.50	4.75
4750	4.75	5.00
5052	5.00	5.25
5255	5.25	5.50
5557	5.50	5.75
5760	5.75	6.00
6062	6.00	6.25
6265	6.25	6.50
6567	6.50	6.75
6770	6.75	7.00

#### Notes:

1. Forward voltage measurement tolerance:  $\pm 0.05V$ .
2. Forward voltage bins are defined at  $I_F = 350mA$  operation.

## 5. Part Number

### CH3535E-UR3501L-AM

Part number is designated with below details.

CH3535E = Product family name.

UR = Color <sup>[1]</sup>

350 = Test current [mA]

1 = Metallic Plating Type ( 0=Ag ; 1=Au ; 2=MLP)

L = Brightness Level ( H=High ; M=Medium ; L=Low)

AM = Automotive Application

Note

[1] Color :

Symbol	Description
C	Cool White
N	Neutral White
W	Warm White
PA	Phosphor Converted Amber
PR	Phosphor Converted Red
UB	Blue
IB	Ice Blue
SB	Sky Blue
UP	Purple
UG	Green
UY	Yellow
UA	Amber
UR	Red
SR	Super Red
RGB	RGB – Color
RGBY	RGBY – Color

## 6. Ordering Information

### CH3535E-UR3501L- **ABCDEFGHIJKLMNO-PQ-AM**

Part Number of the EL 3535E	Order Code
CH3535E-UR3501L-AM	CH3535E-UR3501L- ABCDEFGHJKLMNO-PQ-AM

Order code contains information with below details :

ABCDEF = min/max wavelength or CCT

GHJK = min./max. luminous flux in [lm] or luminous intensity in [mcd]

LMNO = min./max. forward voltage

PQ =Internal code

AM = Automotive Application

## 7. Mechanical Dimension

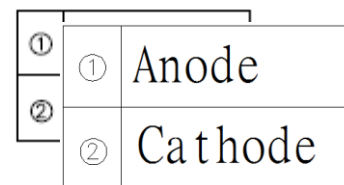
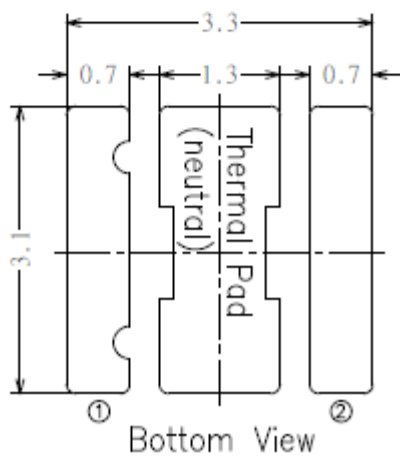
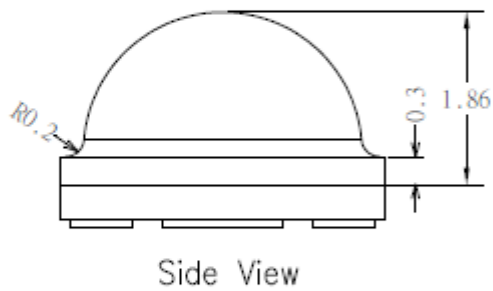
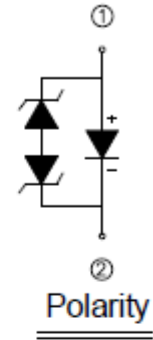
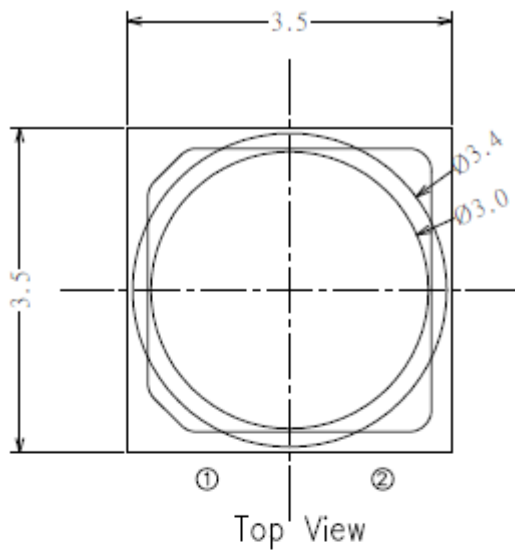

### Notes:

1. Dimensions are in millimeters.
2. Tolerances unless mentioned are  $\pm 0.1$ mm.

## 8. Recommended Soldering Pad

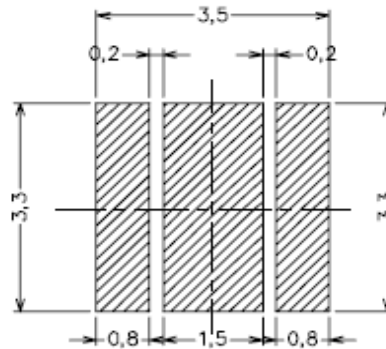

## 9. Reflow Soldering Profile

Soldering Condition (Reference: IPC/JEDEC J-STD-020D)

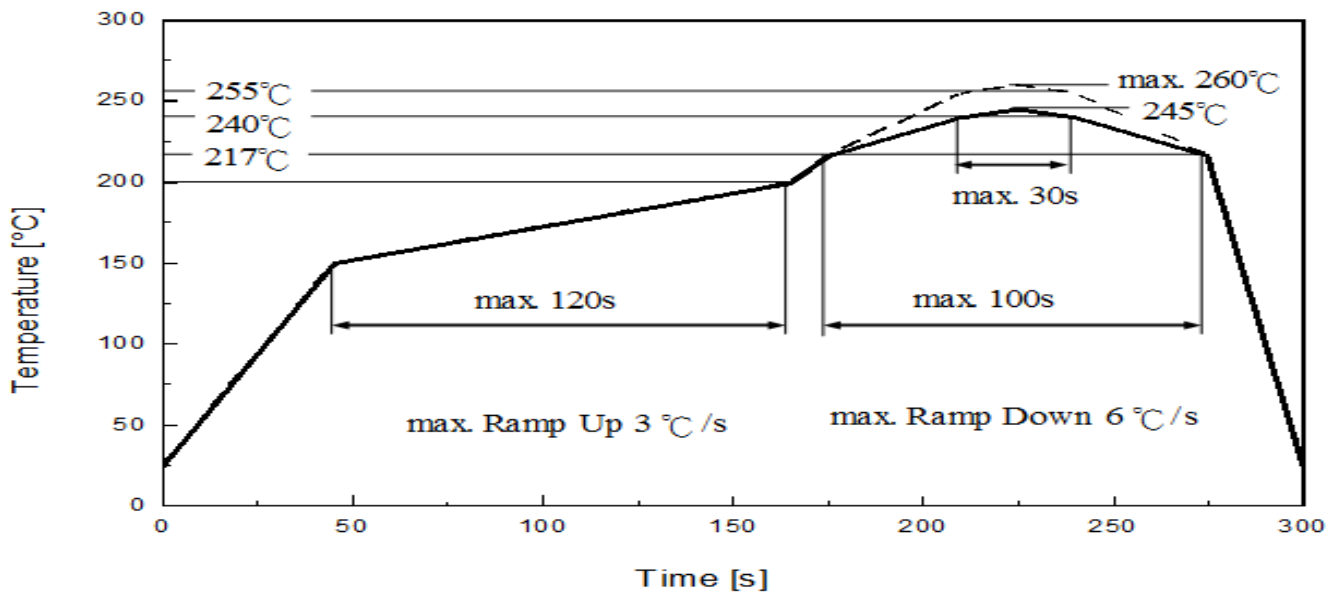

Profile Feature	Pb-Free Assembly	Unit Einheit
	Recommendation	
Ramp-up rate to preheat 25 °C to 150 °C	3	°C /sec
Time of soaking zone 150 °C to 200 °C	120	sec
Ramp-up rate to peak	3	°C /sec
Liquidus temperature	217	°C
Time above liquidus temperature	100	sec
Peak temperature (max.)	260	°C
Time within 5°C of the specified peak temperature	30	sec
Ramp-down Rate (max.)	6	°C /sec



## 10. Packaging Information

### • Product Labeling



- CPN : Customer's Product Number
- P/N : Everlight Part Number
- QTY : Packing Quantity
- CAT : Luminous Flux (Brightness) Bin
- HUE : Color Bin
- REF : Forward Voltage Bin
- LOT No : Lot Number

### • Carrier Tape Dimensions as the following

Packing: Loaded Quantity 400 pcs per reel.

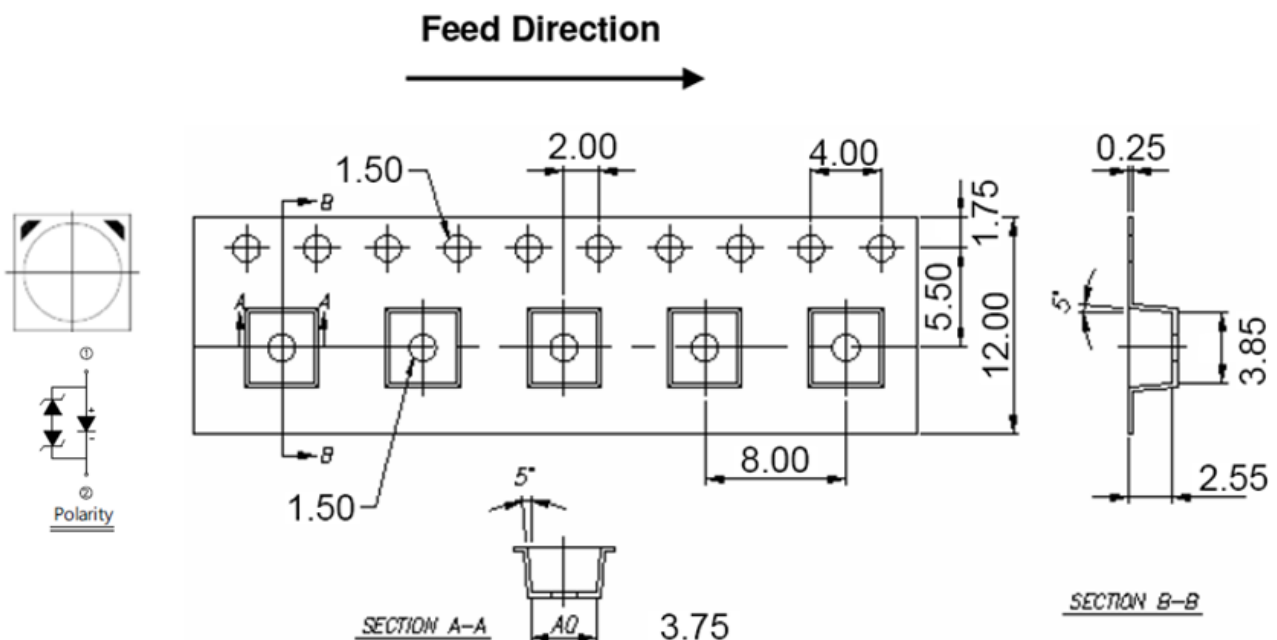

#### Notes:

1. Dimensions are in millimeters.
2. Tolerances for fixed dimensions are  $\pm 0.2\text{mm}$ .

● **Reel Dimensions**

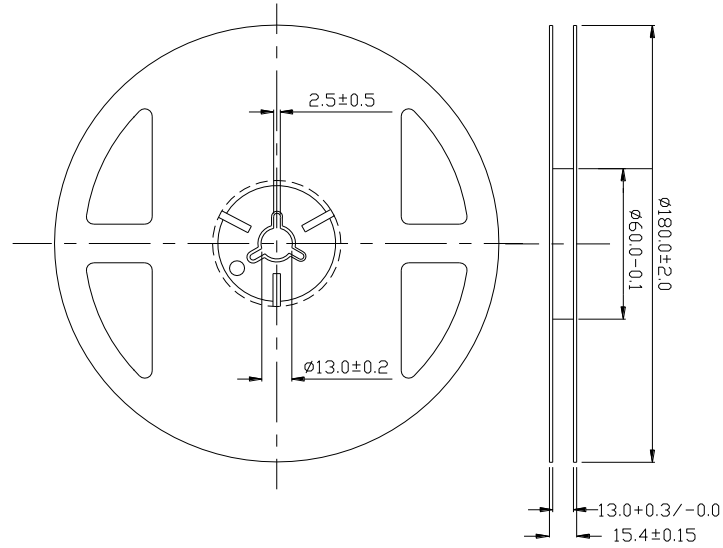

**Notes:**

1. Dimensions are in millimeters.

● **Moisture Resistant Packing Process**

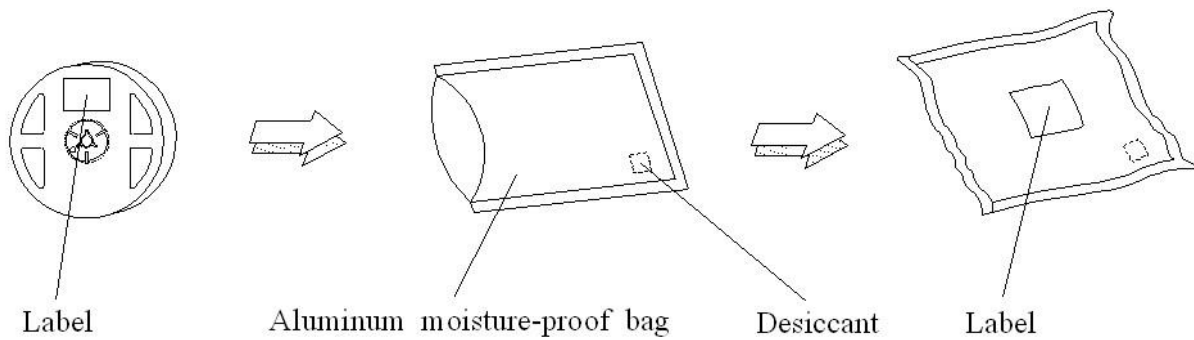

## 11. Precaution for Use

### 1. Over-current-proof

Customer must apply resistors for protection; otherwise slight voltage shift will cause big current change (burn out will happen).

### 2. Assemblies

Do not stack assemblies containing LEDs to prevent damage to the optical surface of LEDs. Forces applied to the optical surface may result in the surface being damaged.

### 3. Soldering Condition

3.1 When soldering, do not put stress on the LEDs during heating.

3.2 After soldering, do not warp the circuit board.

### 4. Soldering Iron

Each terminal is to go to the tip of soldering iron temperature less than 350°C for 3 seconds within once in less than the soldering iron capacity 25W. Leave two seconds and more intervals, and do soldering of each terminal. Be careful because the damage of the product is often started at the time of the hand solder.

### 5. Repairing

Repair should not be done after the LEDs have been soldered. When repairing is unavoidable, a double-head soldering iron should be used (as below figure). It should be confirmed beforehand whether the characteristics of the LEDs will or will not be damaged by repairing.

## Revision History

Current version: Dec.27.2019

Issue No: DHE-0003436

Version: 9

Created by: Sam Lu

Rev.	Subjects (major change in previous version)	Modified date
1	Preliminary	2017/11/14
2	Correct application, change VF bin format	2017/12/07
3	Modify Spectrum	2017/12/19
4	Modify Applications	2018/01/08
5	根據產線產出修改規格	2018/03/28
6	Add Halogen Free in cover page	2018/12/14
7	Add Rth max	2019/04/16
8	Revise dimension picture	2019/06/13
9	Revise thermal pad	2019/12/27

单击下面可查看定价，库存，交付和生命周期等信息

[>>Everlight\(亿光\)](#)