

Infrared Receiver Module IRM-V8xxJ2/TR1 Series



Pin Configuration

1. GND
2. VCC
3. OUT
4. GND

Fig.1 Block Diagram

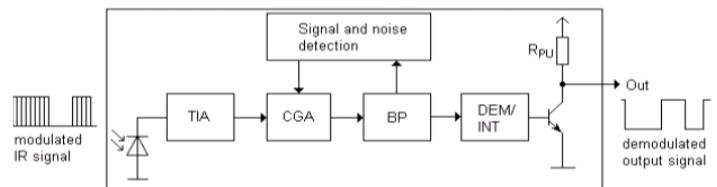

16686

Features

- Available for various carrier frequencies
- Low operating voltage and low power consumption
- High immunity against ambient light
- High immunity against TFT backlight
- Long reception range
- High sensitivity
- Pb free and RoHS compliant
- Compliance with EU REACH
- Compliance Halogen Free (Br < 900 ppm, Cl < 900 ppm, Br+Cl < 1500 ppm)

Description

The IRM-V8xxJ2/TR1 devices are SMD type infrared receivers which have been developed and designed by using the latest IC technology, providing compatibility to most common IR protocols. The PIN diode and preamplifier are assembled onto a lead frame and molded into a black epoxy package which operates as an IR filter. The demodulated output signal can directly be decoded by a microprocessor.

Applications

- AV equipment such as TV, VCR, DVD, CD, MD, etc.
- CATV set top boxes
- Multi-media Equipment
- Other devices using IR remote control

Parts Number Table

Model No.	Carrier Frequency
IRM-V836J2/TR1	36 kHz
IRM-V838J2/TR1	38 kHz
IRM-V840J2/TR1	40 kHz

Absolute Maximum Ratings (Ta=25°C) (note1)

Parameter	Symbol	Rating	Unit
Supply Voltage	V _{cc}	0~6	V
Output current	I _{OUT}	0~2.5	mA
Operating Temperature	T _{opr}	-20 ~ +85	°C
Storage Temperature	T _{stg}	-40 ~ +85	°C
Soldering Temperature (note2)	T _{sol}	260	°C

Electro-Optical Characteristics (Ta=25°C, V_{cc}=3.0V)

Parameter	Symbol	Min.	Typ.	Max.	Unit	Condition
Current consumption	I _{cc}	---	0.53	0.8	mA	No input signal
Supply voltage	V _{cc}	2.7	---	5.5	V	
Peak wavelength	λ _p	---	940	---	nm	
High level output voltage	V _{OH}	V _{cc} -0.3	---	---	V	I _{SOURCE} ≤ 1μA
Low level output voltage	V _{OL}	---	0.2	0.5	V	I _{SINK} ≤ 2mA
Internal pull up resistor	R _{PU}	---	50	---	kΩ	
Reception range	L ₀	8	---	---	m	Test signal according to figure 2
	L ₄₅	5	---	---		
Min reception distance	L _{0min}	---	---	0.1		Output pulse width:
Half angle(horizontal)	φ _h	---	±45	---	deg	400us<T _L <800us
Half angle(vertical)	φ _v	---	±45	---	deg	400us<T _H <800us
High level pulse width	T _H	400	---	800	μs	See chapter test method, L ₀ = 0.1m ~ 8m
Low level pulse width	T _L	400	---	800	μs	

Note1: Absolute Maximum Ratings indicate limits beyond which damage to the device may occur.

Note2: Soldering time ≤ 5 seconds

Test method

The specified electro-optical characteristics are valid under the following conditions.

1. Measurement environment must be a place without extreme reflections
2. Transmitter radiant intensity $I_e = 80\text{mW/sr}$
3. External lighting contains LED lighting with a color temperature of 6000K and illumination at the IR receiver is less than 100lux ($E_v \leq 100\text{Lux}$)
4. Test signal as shown below in figure 3

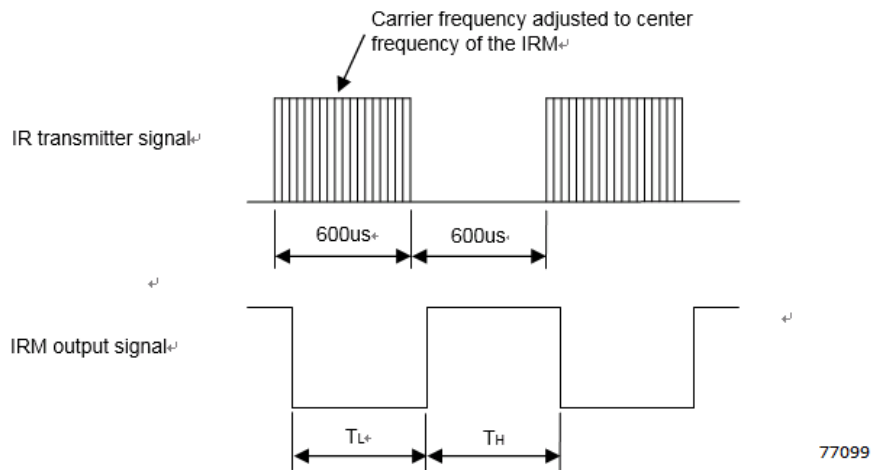

Fig.2 test signal and IRM output signal for reception distance and viewing angle test

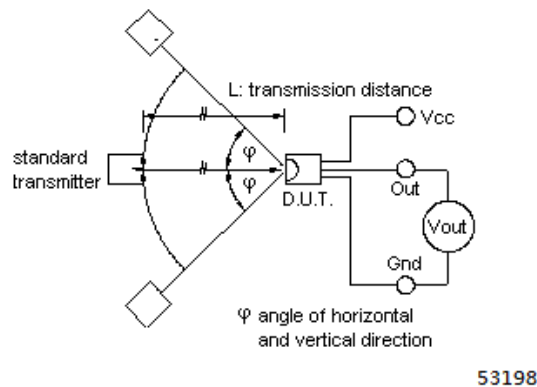

Fig.3 Measuring System

Typical Electro-Optical Characteristics Curves

Fig.4 Relative Responsibility vs. Wavelength

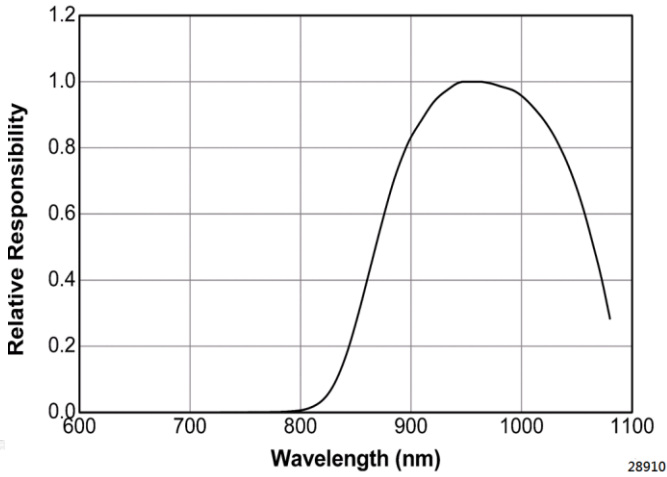

Fig.5 Relative Sensitivity vs. Angle

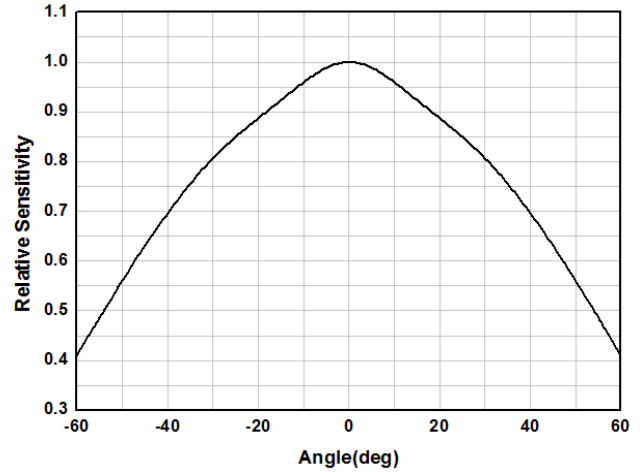

Fig.6 Variation Output Pulse Width vs. Distance

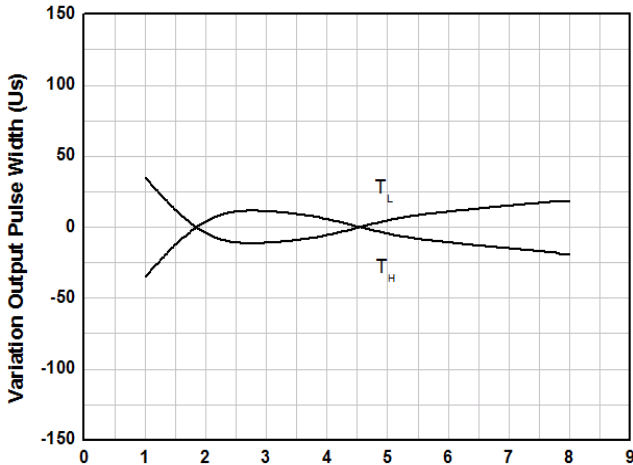

Fig.7 Relative Sensitivity vs. Supply Voltage

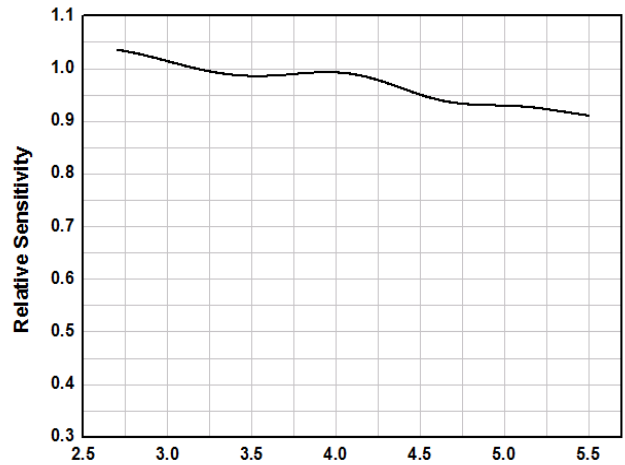
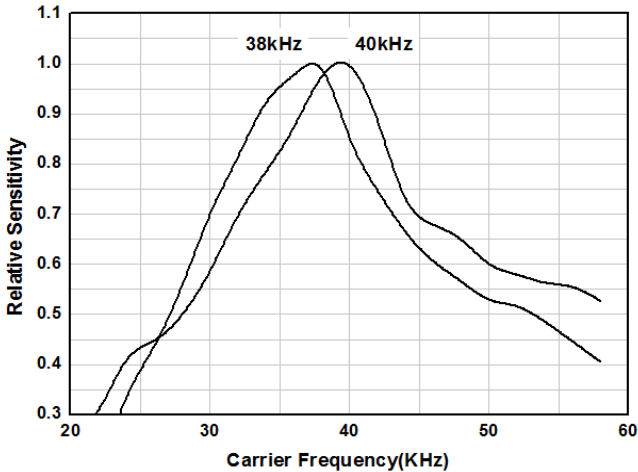

Fig.8 Relative Sensitivity vs. Carrier Frequency



Application considerations

IRM IR receiver modules are high gain analog components to reach a long reception range. However, due to the high gain, they are also sensitive to noise from the power supply like V_{cc} ripple. Noise on the power supply can reduce the reception range of the IRM or cause output glitches and corrupted data. To protect the IRM receiver from power supply noise, a RC filter must be connected as close as possible to the V_{cc} and GND pins of the IRM. The circuit below in figure 9 shows the configuration of the RC filter and the required values. Ceramic or tantalum capacitor should be used, as standard electrolytic capacitors are only suitable for low frequencies and might not be able to filter noise in the frequency range of the IRM. The IRM receiver is most sensitive to noise which is at the carrier frequency or close to the carrier frequency. When using a switching mode power supply, the switching frequency must not be the same as the carrier frequency of the IRM. A gap of at least 20kHz between the switching frequency of the power supply and the IRM carrier frequency is recommended.

If the trace from the IRM output pin to the decoder IC on the PCB is long, the parasitic capacitance might be high causing slow rise times of the IRM output signal. In such case, an additional pull up resistor of 10kOhm or higher can be added at the IRM output to reduce the influence of parasitic trace capacitance.

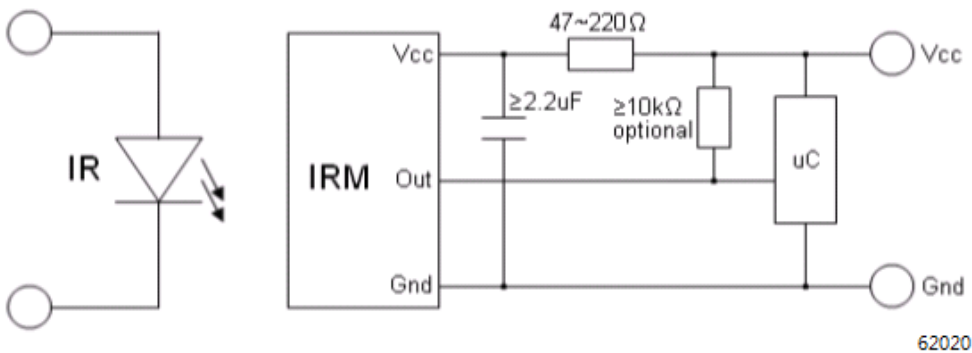

Fig.9: application circuit

Code compatibility

The IRM-V8xxJ2/TR1 receiver modules are mainly designed for remote control applications which require very high noise immunity. Hence the IR code compatibility is matched for the most common IR protocols. To guarantee a proper data signal reception, a few points need to be taken into consideration.

The signal transmission must be carried out in data packages with limited length followed by a data pause time of a certain length. Continuous data transmission is not applicable as such kind of signal will be judged as noise and suppressed after a short time. Table1 below shows the compatibility to most commonly used IR protocols. If an IR protocol is not listed in this table, the compatibility needs to be checked according to the burst times, gap times, data package length and data pause time. The required limits for these items are shown in table 2 “acceptable IR signal timings”.

Protocol	Suitable	Protocol	Suitable	Protocol	Suitable
NEC	Yes	Sony 12 Bit	Yes	RCMM	Yes
Toshiba	Yes	Sony 15 Bit	Yes	RCA	No
RC5	Yes	Sony 20 Bit	Yes	TCL	No
RC6	Yes	XMP	Yes	Thomson	No

Table 1: IR protocol compatibility

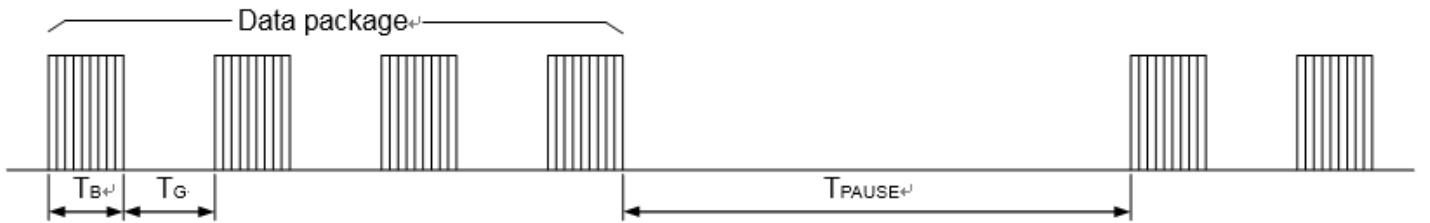

Fig.10: general IR data structure

53113

	IRM-V836J2/TR1 IRM-V838J2/TR1 IRM-V840J2/TR1
Min burst length T_B	150us
Min gap length T_G	275us
Minimum data pause time	Min.9ms
Required data pause time	$t_{Pause} > (\text{Data word length} / 3) + 9\text{ms}$

Table 2: acceptable IR timings

Operation under noisy environment

The IRM-V8xxJ2/TR1 receiver modules are designed for high light noise immunity, especially for noise from fluorescent and energy saving lamps and noise from TFT TVs with CCFL backlight. The receiver is able to suppress most optical noise, but the presence of any kind of optical noise will cause shorter reception range because the AGC will reduce the gain to suppress the noise.

The presence of noise can also affect the output pulse jitter. In such case, the output pulse jitter shown in the electro-optical specification above, might not be valid anymore and bigger pulse jitter can occur. This behavior needs to be considered when tuning the timing limits of the decoder. It is recommended to use the output pulse variation shown in the electro-optical specifications above as a base to set the timing limits of the decoder. However, due to different protocols and environmental conditions, other timing limits might result in better performance and decoding security. This needs to be verified for the specific application by testing under different noise conditions.

Package Dimension

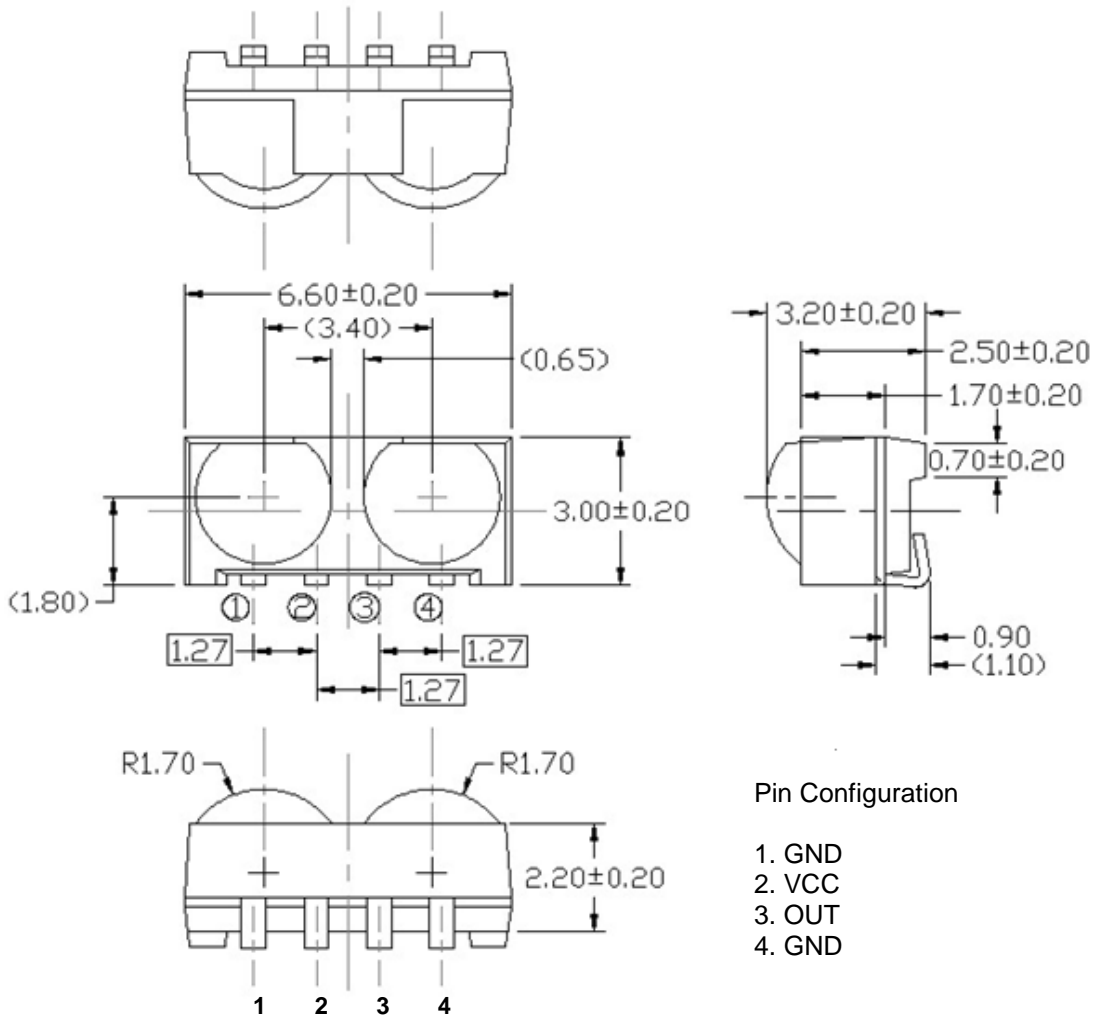

Note: Tolerances unless mentioned ± 0.5 mm. Unit: mm

Recommended pad layout for surface mount leadform

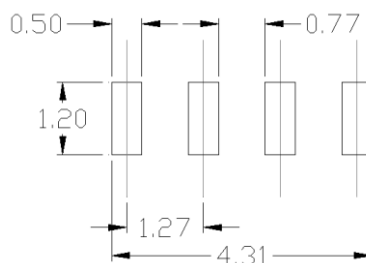

Notice: Suggested pad dimension is just for reference only.
Please modify the pad dimension based on individual need.

Tape & Reel Packing Specifications (Dimensions in mm)

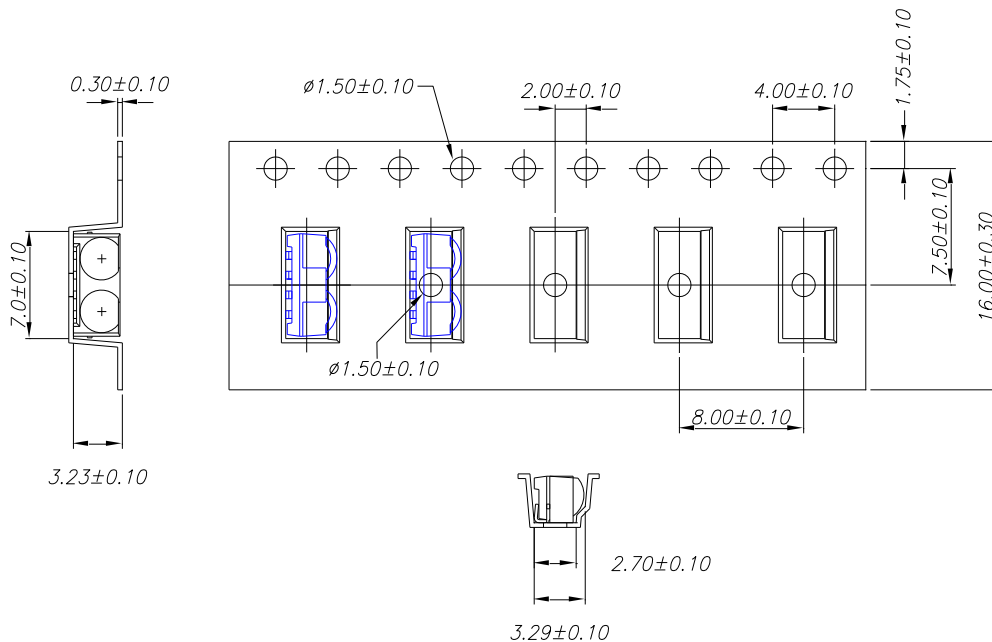

Packing Quantity

2000 pcs / Box
5 Boxes / Carton

Recommended method of storage

The following are general recommendations for moisture sensitive level (MSL) 4 storage and use:

1. Do not open moisture proof bag before devices are ready to use.
2. Shelf life in sealed bag from the bag seal date: 12 months at $10^{\circ}\text{C} \sim 30^{\circ}\text{C}$ and $< 90\% \text{ RH}$.
3. After opening the package, the devices must be stored at $10^{\circ}\text{C} \sim 30^{\circ}\text{C}$ and $\leq 60\% \text{ RH}$, and used within 72 hours (floor life).
4. If the moisture absorbent material (desiccant material) has faded or unopened bag has exceeded the shelf life or devices (out of bag) have exceeded the floor life, baking treatment is required.
5. If baking is required, refer to IPC/JEDEC J-STD-033 for bake procedure or recommend the following conditions: 96 hours at $60^{\circ}\text{C} \pm 5^{\circ}\text{C}$ and $< 5\% \text{ RH}$.

ESD Precaution

Proper storage and handling procedures should be followed to prevent ESD damage to the devices especially when they are removed from the Anti-static bag. Electro-Static Sensitive Devices warning labels are on the packing.

Solder Reflow Temperature Profile

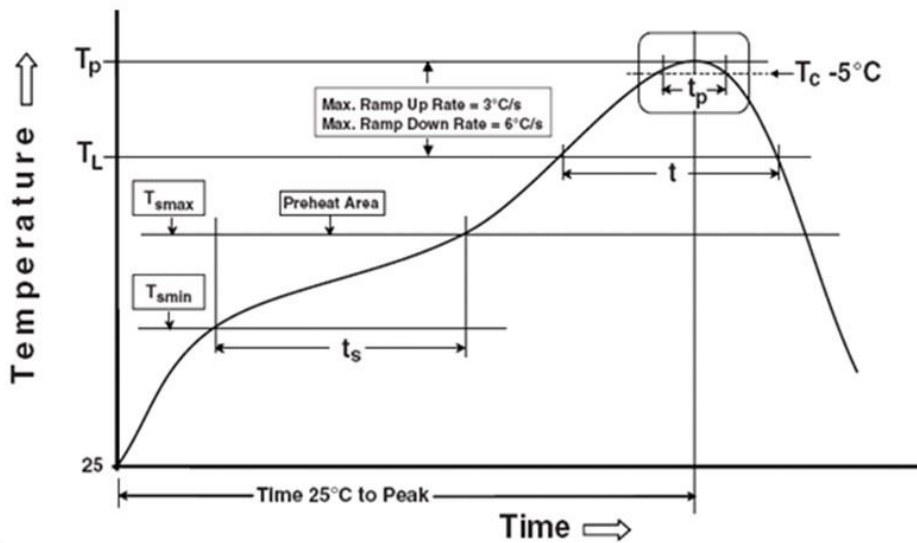

Note:

Reference: IPC/JEDEC J-STD-020D

Preheat

Temperature min (T _{smin})	150 °C
Temperature max (T _{smax})	200°C
Time (T _{smin} to T _{smax}) (t _s)	60-120 seconds
Average ramp-up rate (T _{smax} to T _p)	3 °C/second max

Other

Liquidus Temperature (T _L)	217 °C
Time above Liquidus Temperature (t _L)	60-100 sec
Peak Temperature (T _p)	260°C
Time within 5 °C of Actual Peak Temperature: T _p - 5°C	30 s
Ramp- Down Rate from Peak Temperature	6°C /second max.
Time 25°C to peak temperature	8 minutes max.
Reflow times	2 times

Note:

1. Reflow soldering should not be done more than two times.
2. When soldering, do not put stress on the IRM device during heating.
3. After soldering, do not warp the circuit board.

DISCLAIMER

1. EVERLIGHT reserves the right(s) on the adjustment of product material mix for the specification.
2. The product meets EVERLIGHT published specification for a period of twelve (12) months from date of shipment.
3. The graphs shown in this datasheet are representing typical data only and do not show guaranteed values.
4. When using this product, please observe the absolute maximum ratings and the instructions for using outlined in these specification sheets. EVERLIGHT assumes no responsibility for any damage resulting from the use of the product which does not comply with the absolute maximum ratings and the instructions included in these specification sheets.
5. These specification sheets include materials protected under copyright of EVERLIGHT. Reproduction in any form is prohibited without obtaining EVERLIGHT's prior consent.
6. This product is not intended to be used for military, aircraft, automotive, medical, life sustaining or life saving applications or any other application which can result in human injury or death. Please contact authorized Everlight sales agent for special application request.

单击下面可查看定价，库存，交付和生命周期等信息

[>>Everlight \(亿光\)](#)