

# Technical Data Sheet

## Opto Interrupter

**ITR8307/S17/TR8**

### Features

- Fast response time
- High sensitivity
- Cut-Off visible wavelength
- Thin
- Compact
- Pb free
- This product itself will remain within RoHS compliant version.

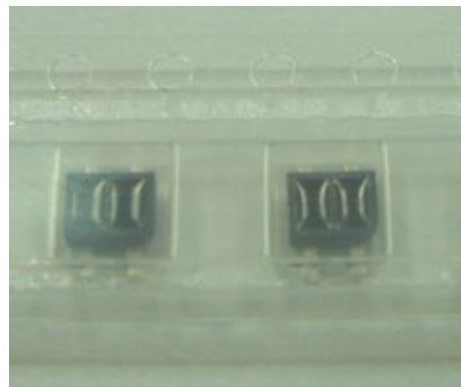

### Descriptions

**ITR8307/S17/TR8** is a light reflection switch which includes a GaAs IR-LED transmitter and a NPN photo-transistor with a high photosensitive receiver for short distance, operating in the infrared range. Both components are mounted side- by- side in a plastic package.

### Applications

- Camera
- VCR
- Floppy disk driver
- Cassette type recorder
- Various microcomputer control equipment

### Device Selection Guide

Device No.	Chip Material
IR	GaAs
PT	Silicon

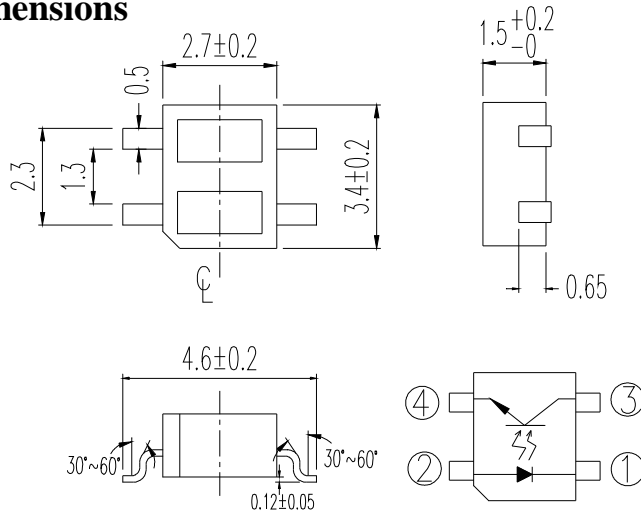
**Technical Data Sheet**  
**Opto Interrupter**
**ITR8307/S17/TR8**
**Package Dimensions**

- ① : CATHODE      ③ : COLLECTOR  
 ② : ANODE        ④ : EMITTER

- Notes:** 1. All dimensions are in millimeters  
 2. Tolerances unless dimensions  $\pm 0.15\text{mm}$

**Absolute Maximum Ratings (Ta=25 °C)**

Parameter		Symbol	Ratings	Unit
Input	Power Dissipation at (or below) 25 °C Air Temperature	Pd	75	mW
	Reverse Voltage	V <sub>R</sub>	5	V
	Forward Current	I <sub>F</sub>	50	mA
	Peak Forward Current (*1) Pulse width 100 μs, Duty cycle=1%	I <sub>FP</sub>	1	A
	Collector Power Dissipation	P <sub>C</sub>	75	mW
Output	Collector Current	I <sub>C</sub>	50	mA
	Collector-Emitter Voltage	B V <sub>CEO</sub>	30	V
	Emitter-Collector Voltage	B V <sub>ECO</sub>	5	V
	Operating Temperature	T <sub>opr</sub>	-25~+85	
Storage Temperature	T <sub>stg</sub>	-30~+90		
Lead Soldering Temperature (*2)	T <sub>sol</sub>	260		

(\* 1)  $t_w=100 \mu \text{sec.}$ ,  $T=10 \text{msec.}$       (\* 2)  $t=5 \text{Sec}$



# Technical Data Sheet

## Opto Interrupter

ITR8307/S17/TR8

### Electro-Optical Characteristics (Ta=25 °C)

Parameter		Symbol	Min.	Typ.	Max.	Unit	Conditions
Input	Forward Voltage	$V_F$	---	1.2	1.6	V	$I_F=20mA$
	Reverse Current	$I_R$	---	---	10	$\mu A$	$V_R=5V$
	Peak Wavelength	$\lambda_P$	---	940	---	nm	---
Output	Dark Current	$I_{CEO}$	---	---	100	nA	$V_{CE}=10V$
	C-E Saturation Voltage	$V_{CE(sat)}$	---	---	0.4	V	$I_C=2mA$ $E_e=1mW/cm^2$
Transfer Characteristics	Light Current	$I_C(ON)$	0.18	---	0.44	mA	$V_{CE}=5V$
	Leakage Current	$I_{CEOD}$	---	---	1	$\mu A$	$I_F=10mA$
	Rise time	$t_r$	---	20	---	$\mu sec$	$V_{CE}=2V$
	Fall time	$t_f$	---	20	---	$\mu sec$	$I_C=100 \mu A$ $R_L=1K\Omega$

### Rank

Conditions :  $I_F=10mA$   $V_{CE}=5V$ Unit:  $\mu$ 

Bin number	Min	Max
B	180	300
C	250	440

**Technical Data Sheet  
Opto Interrupter**
**ITR8307/S17/TR8**
**Typical Electrical/Optical/Characteristics Curves for IR**

Fig. 1 Forward Current vs. Ambient Temperature

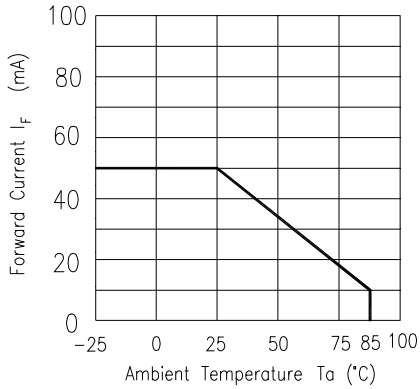

Fig. 2 Spectral Distribution

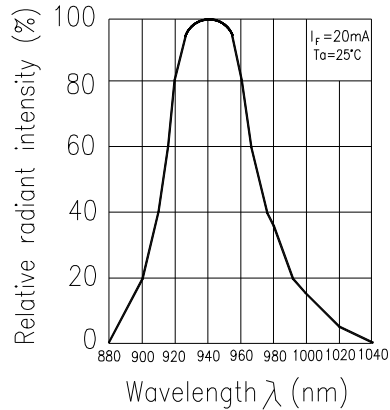

Fig. 3 Peak Emission Wavelength vs. Ambient Temperature

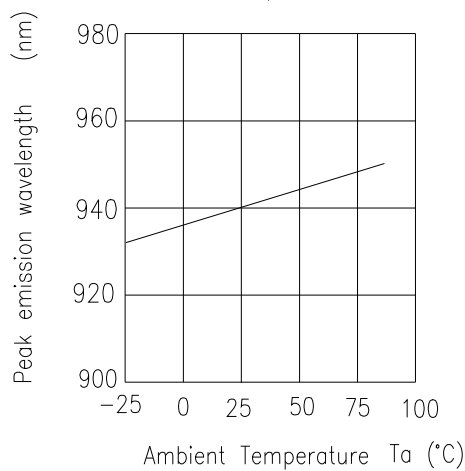

Fig. 4 Forward Current vs. Forward Voltage

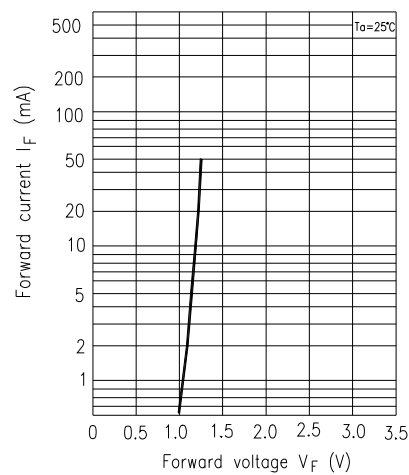

Fig. 5 Forward Voltage vs. Ambient Temperature

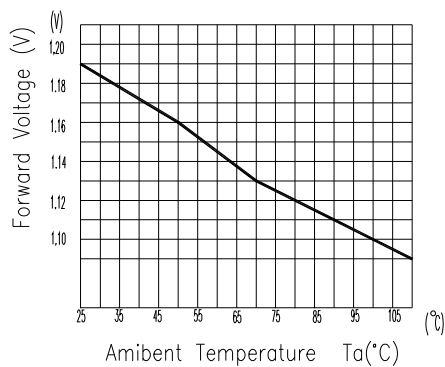
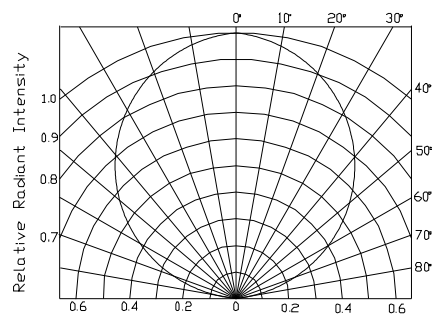

Fig. 6 Relative Radiant Intensity vs. Angular Displacement



**Technical Data Sheet**  
**Opto Interrupter**
**ITR8307/S17/TR8**
**Typical Electro/Optical/Characteristics Curves for PT**

Fig.1 Collector Power Dissipation vs. Ambient Temperature

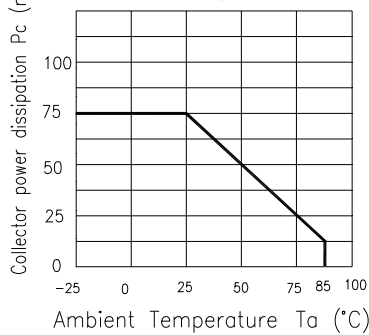

Fig.2 Collector Dark Current vs. Ambient Temperature

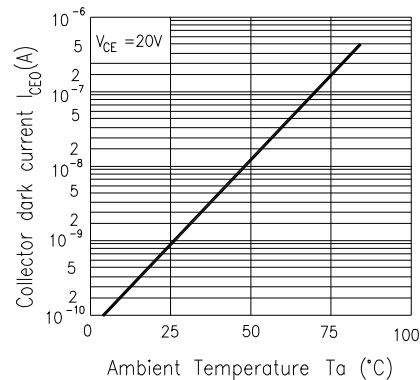

Fig. 3 Relative Collector Current vs. Ambient Temperature

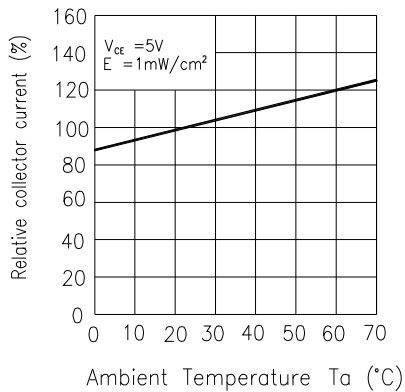

Fig.4 Collector Current vs. Irradiance

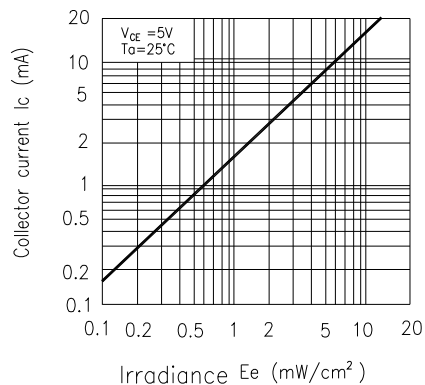

Fig.5 Spectral Sensitivity

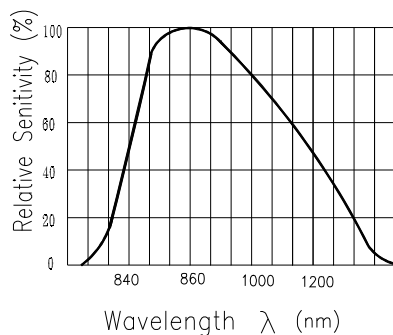
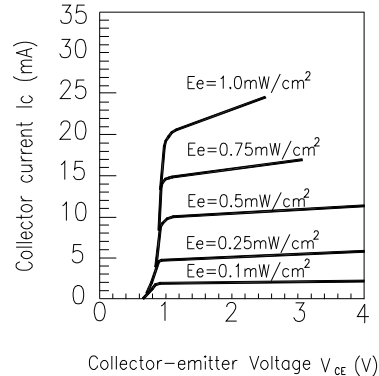

Fig.6 Collector Current vs. Collector-emitter Voltage



Technical Data Sheet  
Opto Interrupter

ITR8307/S17/TR8

Typical Electrical/Optical/Characteristics Curves For ITR

Fig.1 Relative Collector Current vs. Distance between Sensor and Al Evaporation Glass

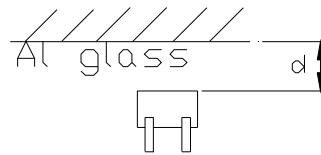
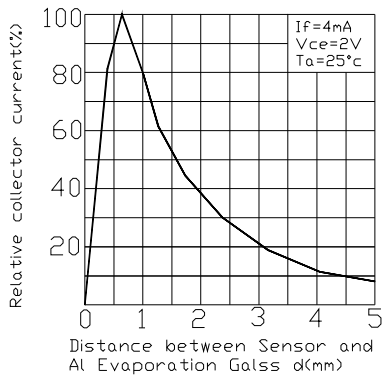

Fig.2 Relative Collector Current vs. Card Moving Distance (1)

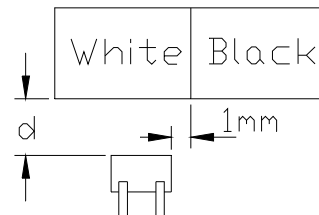
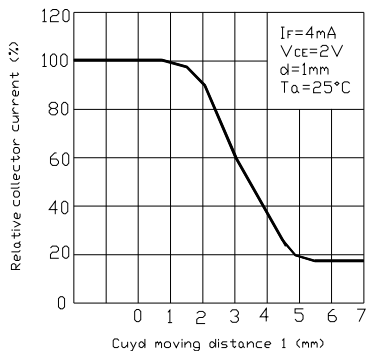
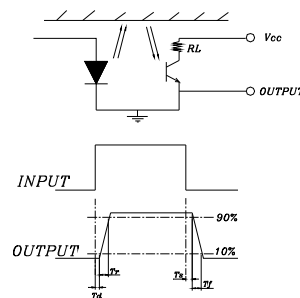
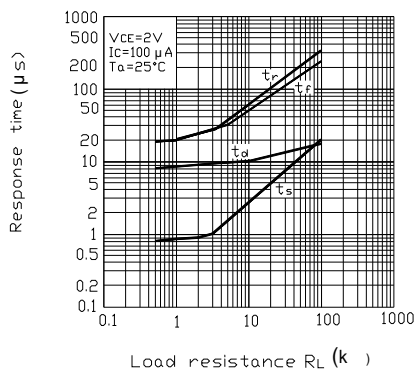

Fig.3 Response Time vs. Load Resistance





Technical Data Sheet
Opto Interrupter

ITR8307/S17/TR8

Reliability Test Item And Condition

The reliability of products shall be satisfied with items listed below.

Confidence level : 90%

LTPD : 10%

Table with 7 columns: NO., Item, Test Conditions, Test Hours/Cycles, Sample Sizes, Failure Judgement Criteria, Ac/Re. Rows include Solder Heat, Temperature Cycle, Thermal Shock, High Temperature Storage, Low Temperature Storage, DC Operating Life, and High Temperature/High Humidity.

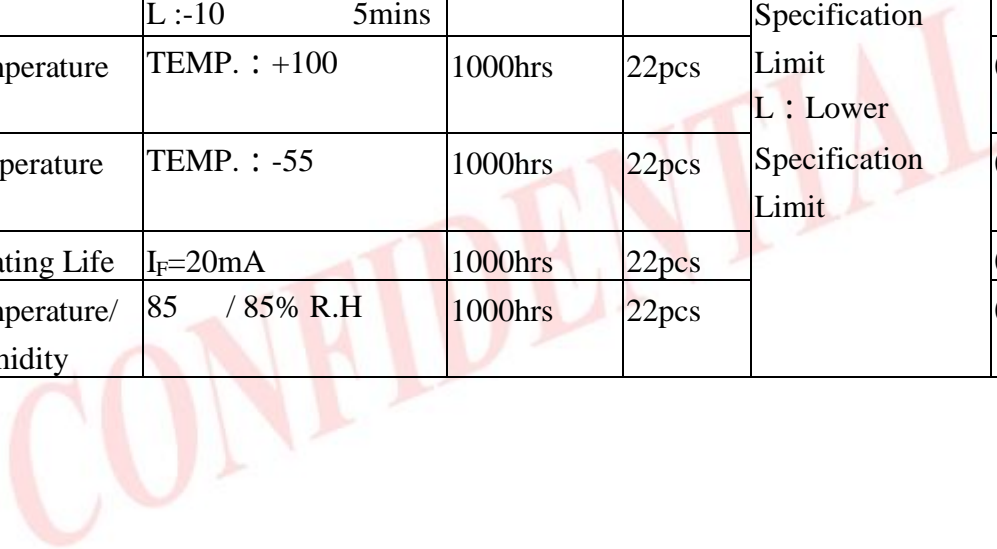

**Technical Data Sheet**  
**Opto Interrupter**
**ITR8307/S17/TR8**
**Recommended Method of Storage**

The following are general recommendations for moisture sensitive level (MSL) 4 storage and use:

- Shelf life in sealed bag: 12 months at < 40 °C and < 90% relative humidity (RH)
- After bag is opened, devices that will be subjected to reflow solder or other high temperature process must
  - a) Mounted within 72 hours of factory conditions < 30 °C/60%RH, or
  - b) Stored at <20% RH
- Devices require bake, before mounting, if:  
Humidity Indicator Card is > 20% when read at 23 ± 5 °C
- If baking is required, devices may be baked:
  - a) 192 hours at 40 °C, and <5% RH(dry air/nitrogen) or
  - b) 96 hours at 60 °C, and <5% RH for all device containers
  - c) 24 hours at 125 °C
- Soldering Condition
  - a) Pb-free solder temperature profile

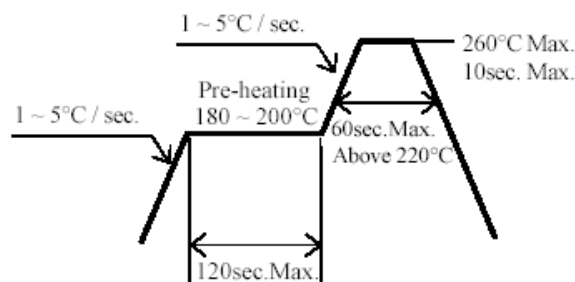

- b) Reflow soldering should not be done more than two times.
  - c) When soldering, do not put stress on the LEDs during heating.
  - d) After soldering, do not warp the circuit board.
- Repairing

Repair should not be done after the LEDs have been soldered. When repairing is unavoidable, a double-head soldering iron should be used (as below figure). It should be confirmed beforehand whether the characteristics of the LEDs will or will not be damaged by repairing.

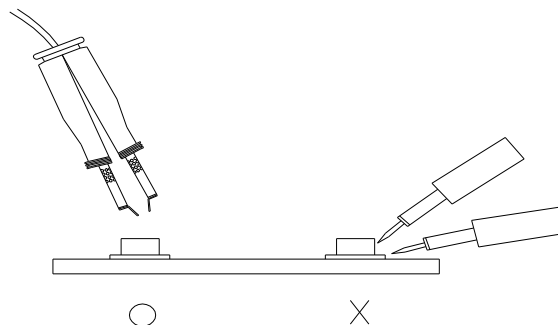



Technical Data Sheet  
Opto Interrupter

ITR8307/S17/TR8

Taping Dimension

Progressive direction →

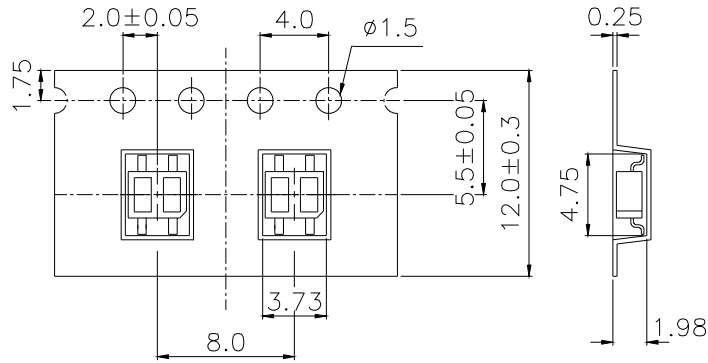

General Tolerance  $\pm 0.1$   
UNIT:mm

Reel Dimensions

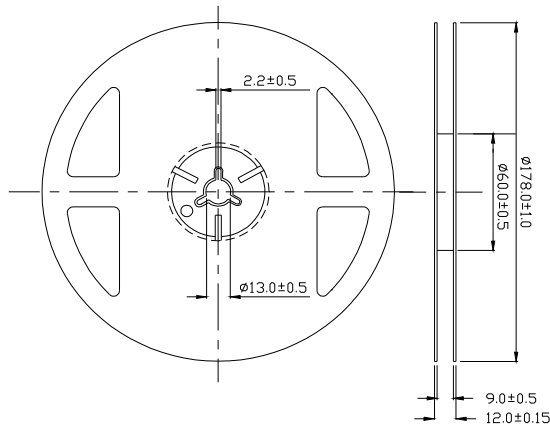

Note: The tolerances unless mentioned is  $\pm 0.1$ mm ,Unit = mm

Moisture Resistant Packaging

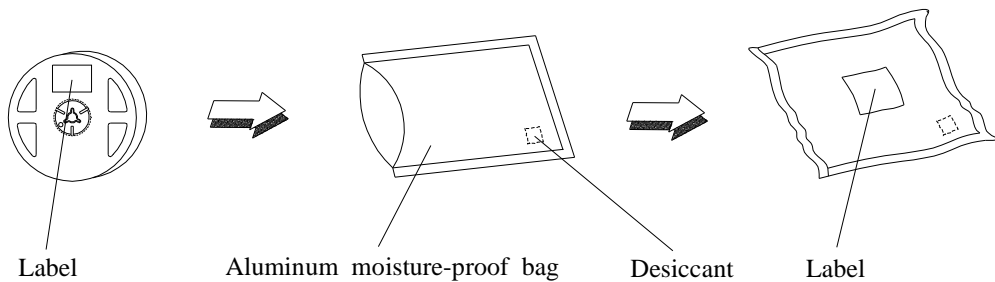



Technical Data Sheet
Opto Interrupter

ITR8307/S17/TR8

Packing Quantity Specification

- 1. 1000 Pcs/ 1Reel
2. 15 Reel /1 Box
3. 2 Box/ 1 Carton

Label Form Specification

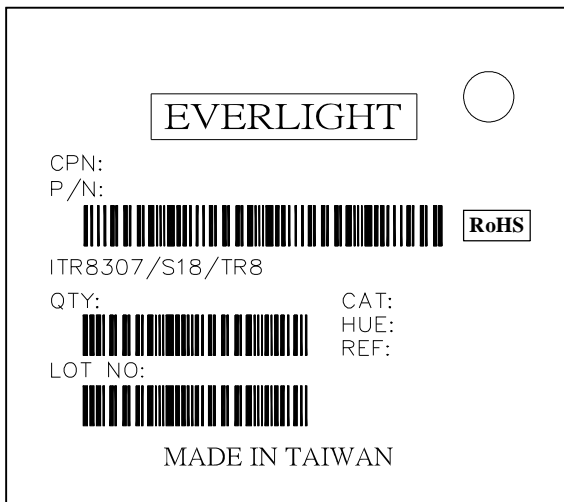

CPN: Customer's Production Number
P/N : Production Number
QTY: Packing Quantity
CAT: None
HUE: None
REF: Reference
LOT No: Lot Number
MADE IN TAIWAN: Production Place

Notes

- 1. Above specification may be changed without notice. EVERLIGHT will reserve authority on material change for above specification.
2. When using this product, please observe the absolute maximum ratings and the instructions for using outlined in these specification sheets. EVERLIGHT assumes no responsibility for any damage resulting from use of the product which does not comply with the absolute maximum ratings and the instructions included in these specification sheets.
3. These specification sheets include materials protected under copyright of EVERLIGHT corporation. Please don't reproduce or cause anyone to reproduce them without EVERLIGHT's consent.

EVERLIGHT ELECTRONICS CO., LTD.
Office: No 25, Lane 76, Sec 3, Chung Yang Rd,
Tucheng, Taipei 236, Taiwan, R.O.C

Tel: 886-2-2267-2000, 2267-9936
Fax: 886-2267-6244, 2267-6189, 2267-6306
http://www.everlight.com

单击下面可查看定价，库存，交付和生命周期等信息

[>>Everlight \(亿光\)](#)