

ELCH07-NB5060J6J8283910-F3H

### Received

- MASS PRODUCTION
- PRELIMINARY
- CUSTOMER DESIGN

DEVICE NO. : DHE-0003015

PAGE : 13

### Revised record

REV.	DESCRIPTION	RELEASE DATE
1	New spec	Feb.05.2016
2	For ECR*55269 add Page.13 DISCLAIMER	Nov.23.2016

## ELCH07-NB5060J6J8283910-F3H



### Features

- Feature of the device : small package with high efficiency
- Typical luminous flux@ 1A : 260 lm
- Optical efficiency@1A : 76.4 lm/W
- ESD protection (according to JEDEC 3b) (HBM air or contact discharge) up to 8KV
- Binning Parameters : Brightness, Forward Voltage and Chromaticity
- Grouping parameter: total luminous flux, color coordinates.
- RoHS compliant & Pb free
- Compliance with EU REACH
- Compliance Halogen Free .(Br <900 ppm ,Cl <900 ppm , Br+Cl < 1500 ppm).

### Applications

- Mobile Phone Camera Flash(Camera flash light /strobe light for mobile devices )
- Torch light for DV(Digital Video) application
- Indoor lighting applications
- Signal and symbol luminaries for orientation marker lights (e.g. steps, exit ways, etc.)
- TFT backlighting
- Exterior and interior illumination applications
- Decorative and Entertainment Lighting
- Exterior and interior automotive illumination

## Device Selection Guide

Chip Materials	Emitted Color
InGaN	White

## Absolute Maximum Ratings

Parameter	Symbol	Rating	Unit
DC Forward Current (Torch Mode)	$I_F$	350	mA
Peak Pulse Current	$I_{Pulse}$	1200	mA
ESD Resistance (JEDEC 3b)	$V_B$	8000	V
Reverse Voltage	$V_R$	Note 1	V
Junction Temperature	$T_j$	125	°C
Operating Temperature	$T_{Opr}$	-40 ~ +85	°C
Storage Temperature	$T_{Stg}$	-40 ~ +100	°C
Soldering Temperature	$T_{Sol}$	260	°C
Allowable Reflow Cycles	n/a	2	Cycles
Substrate Temperature	$T_s$	70(IF=1000mA)	°C
Viewing Angle <sup>(2)</sup>	$2\theta_{1/2}$	120	Deg
Power Dissipation (Pulse Mode)	$P_d$	4.74	W

### Notes:

1. The Chin series LEDs are not designed for reverse bias used.
2. View angle measurement tolerance  $\pm 5^\circ$
3. Avoid operating Chin series LEDs at maximum operating temperature exceed 1 hour.
4. All specification are assured by reliability test for 1000hr, IV degradation less than 30%.
5. All reliability item are tested under good thermal management with 1.0 x 1.0 cm<sup>2</sup> MCPCB
6. Peak pulse current shall be applied under conditions as max duration time 400 ms and max duty cycle 10%
7. Operate LED component at maximum rating conditions continuously will cause possible permanent damage and de-rating parameters. Exercise multiple maximum rating parameters simultaneously should not be allowed. When maximum rating parameters are applied over a long period will result potential reliability issue.

## JEDEC Moisture Sensitivity

Level	Floor Life		Soak Requirements Standard	
	Time ( hours )	Conditions	Time ( hours )	Conditions
1	Unlimited	≤30°C / 85% RH	168 (+5/-0)	85°C / 85% RH

## Electro-Optical Characteristics (Ts=25°C)

Parameter	Symbol	Min.	Typ.	Max.	Unit	Condition
Luminous Flux <sub>(1)</sub>	I <sub>v</sub>	220	260	----	lm	I <sub>F</sub> =1000mA
Forward Voltage <sub>(2)(3)</sub>	V <sub>F</sub>	2.85	----	3.95	V	
Color Temperature	CCT	5000	----	6000	K	

## Forward Voltage Binning

Bin	Symbol	Min.	Typ.	Max.	Unit	Condition
2832	V <sub>F</sub>	2.85	----	3.25	V	I <sub>F</sub> =1000mA
3235	V <sub>F</sub>	3.25	----	3.55		
3539	V <sub>F</sub>	3.55	----	3.95		

## Luminous Flux Binning

Bin	Symbol	Min.	Typ.	Max.	Unit	Condition
J6	I <sub>v</sub>	220	----	250	I <sub>v</sub>	I <sub>F</sub> =1000mA
J7	I <sub>v</sub>	250	----	300		
J8	I <sub>v</sub>	300	----	330		

### Notes:

1. Luminous Flux, illuminance measurement tolerance : ±10%
2. Forward voltage measurement tolerance : ±0.1V
3. Electric and optical data is tested at 50 ms pulse condition.
4. Temperature of solder pad : 25°C

## White Bin Structure

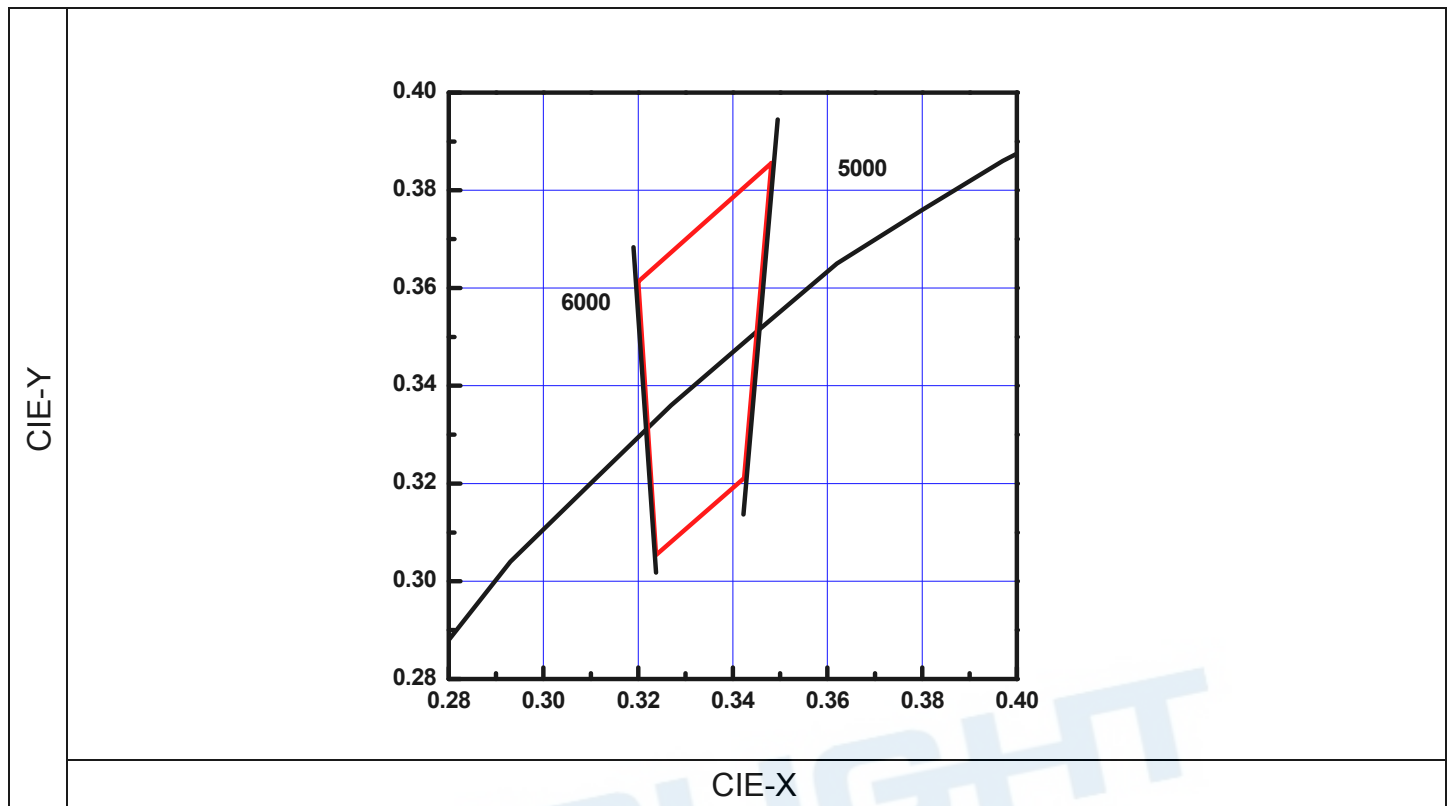

Bin	CIE-X	CIE-Y	Reference Range
5060	0.3482	0.3856	5000 ~ 6000K
	0.3200	0.3613	
	0.3238	0.3054	
	0.3424	0.3211	

**Notes:**

1. Color coordinates measurement allowance :  $\pm 0.01$
2. Color bins are defined at  $I_f=1000\text{mA}$  operation.

## Typical Electro-Optical Characteristics Curves

Relative Spectral Distribution ,  $I_F=1000\text{mA}$  @  $50\text{ms}$ ,  $T_{\text{solder pad}}=25^\circ\text{C}$

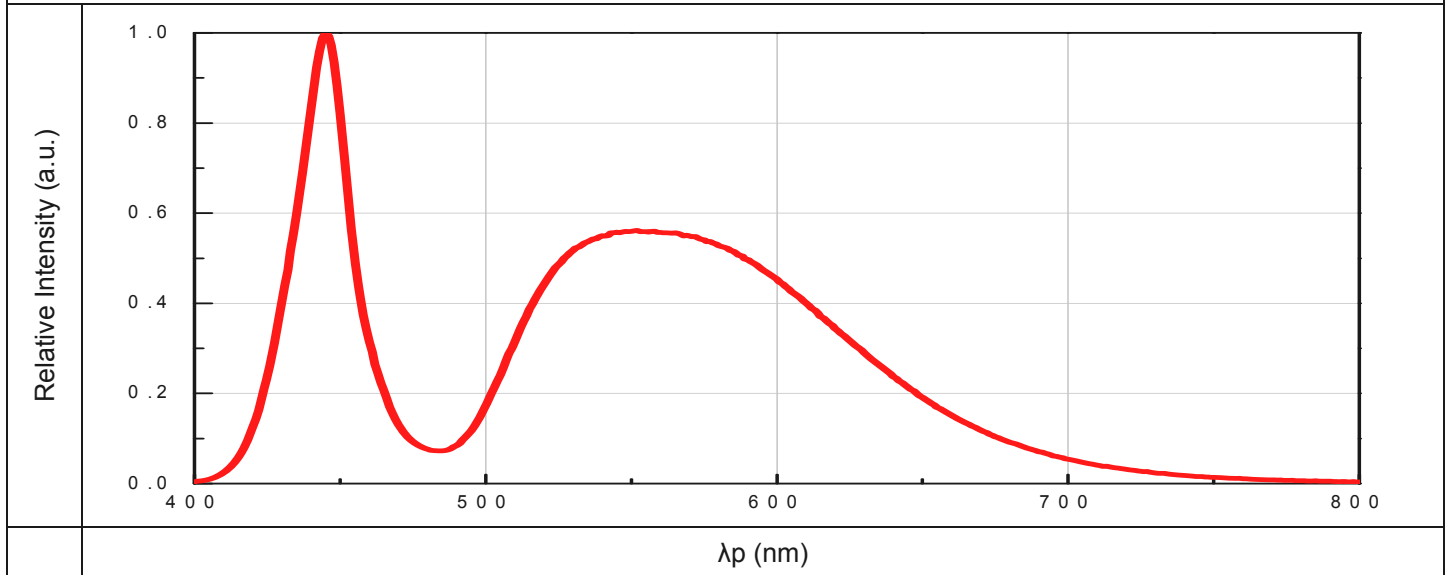

Typical Radiation Patterns

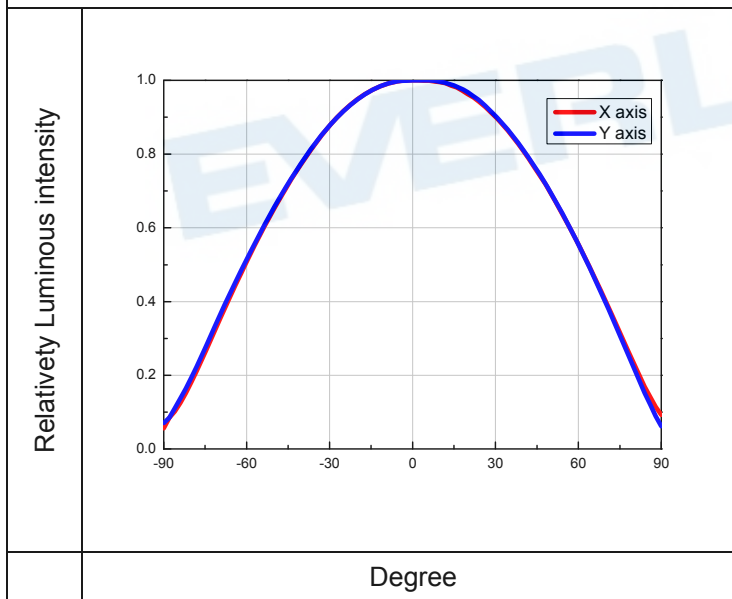

Typical Polar Radiation Pattern for Lambertian

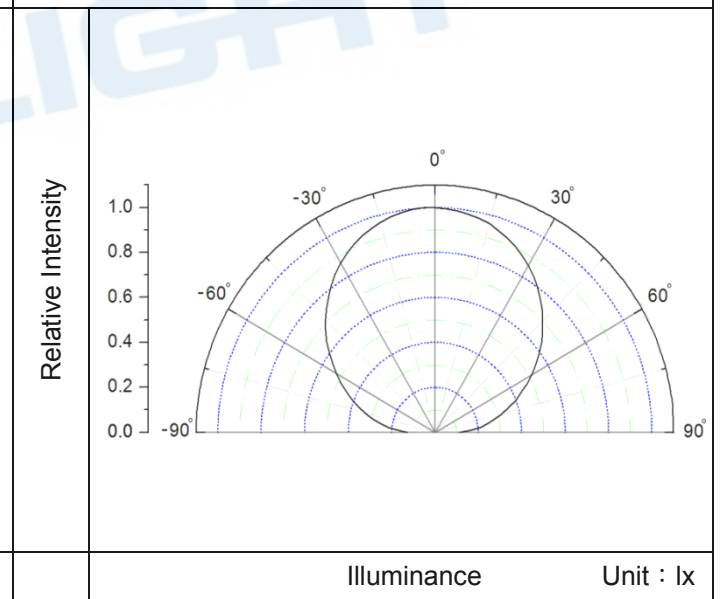

**Notes:**

1.  $2\theta_{1/2}$  is the off axis from lamp centerline where the luminous intensity is 1/2 of the peak value.
2. View angle tolerance is  $\pm 5^\circ$

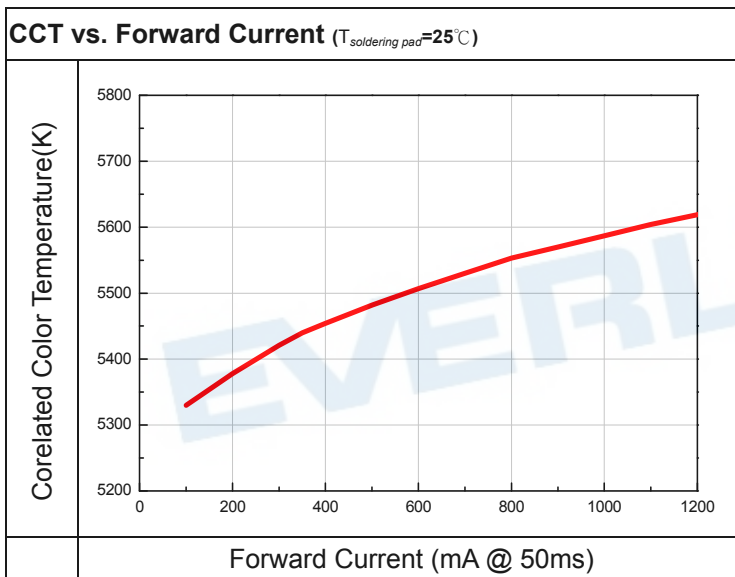
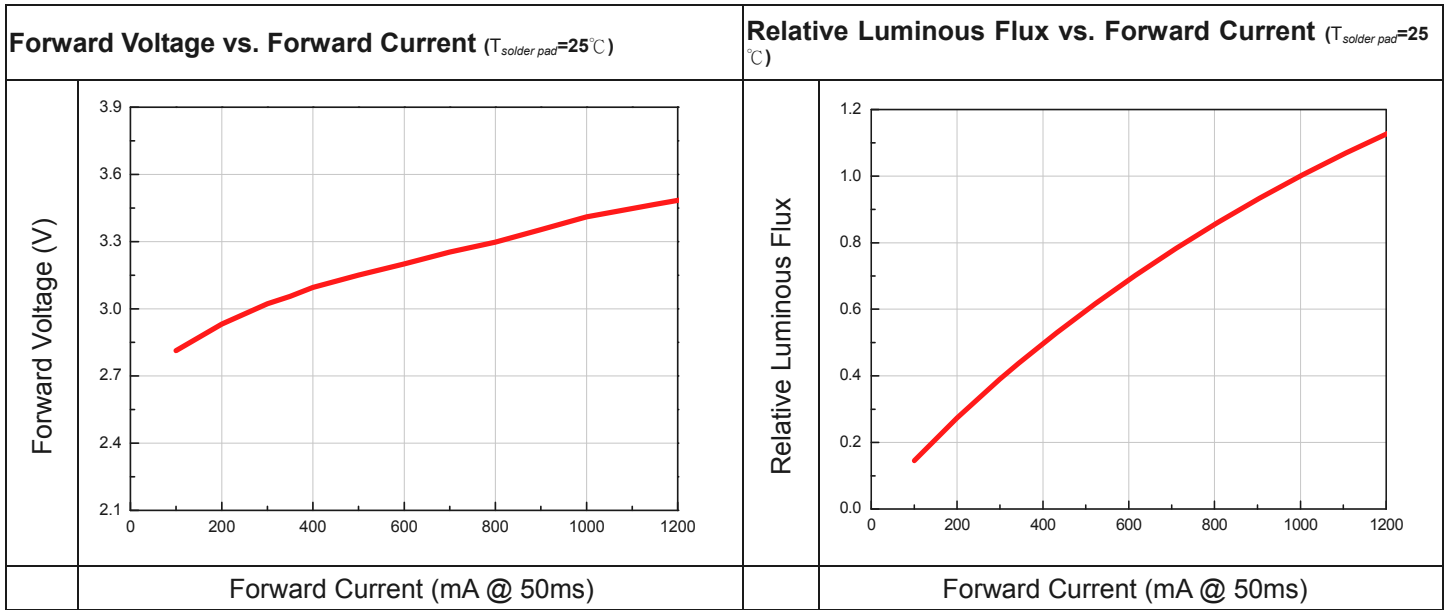

**Notes:**

1. All correlation data is tested under superior thermal management with 1 x 1 cm<sup>2</sup> MCPCB.

## Package Dimension

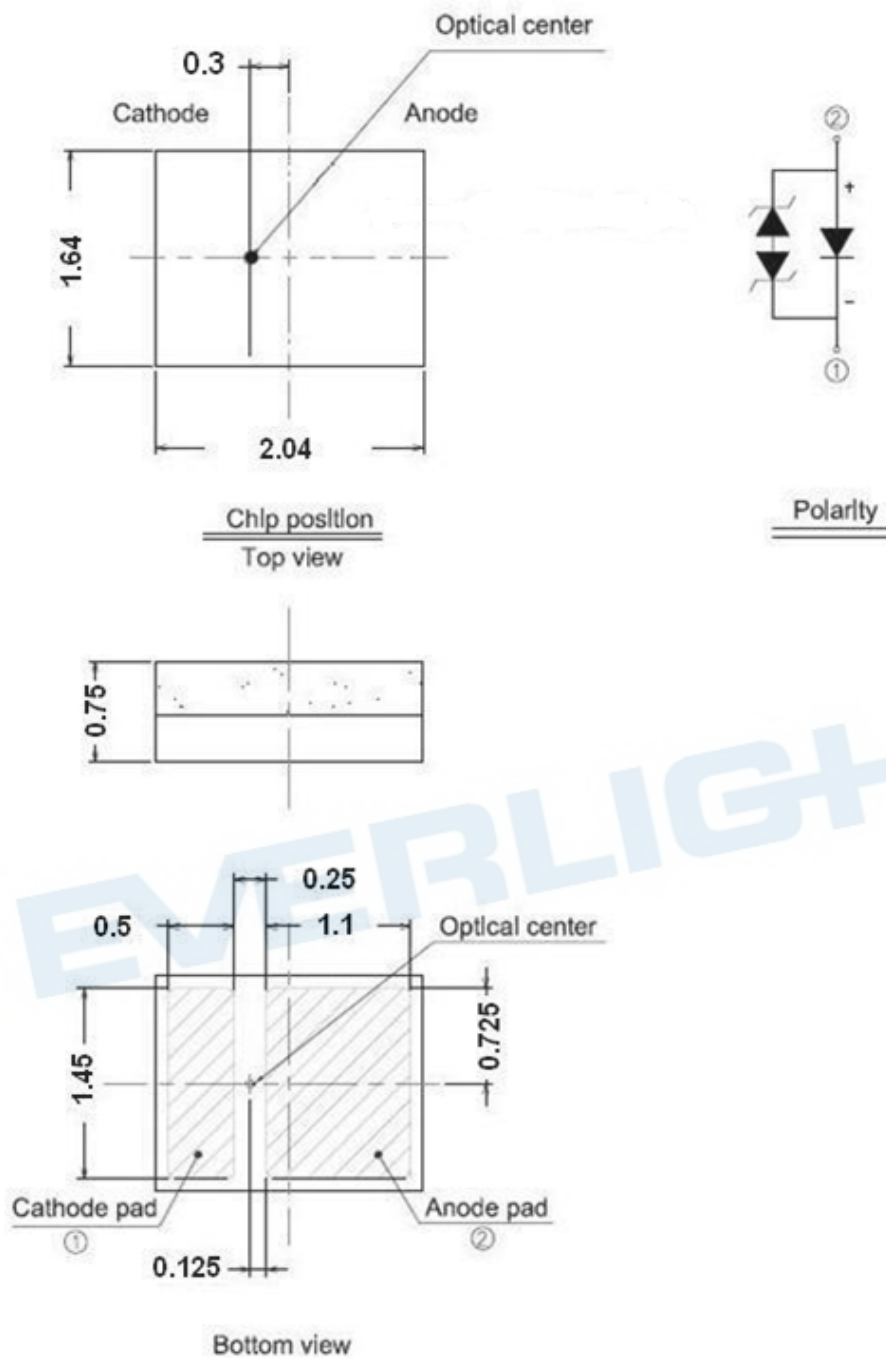

### Notes:

1. Dimensions are in millimeters.
2. Tolerances unless mentioned are  $\pm 0.1\text{mm}$ .



## Moisture Resistant Packing Materials

### Product Labeling

RoHS **Pb** EVERLIGHT 5

CPN: XXXXXXXXXXXXXXXXXXXX  
 XXXXXXXXXXX-XXXXXXXX-XXXXXXXX-XXXXXX  
 P/N: XXXXXXXXXXX  
 XXXXXXXXXXX-XXXXXXXX-XXXXXXXX-XXXXXX  
 LOT NO: Y150716XXX-XXXXXXXX-XXXXXXXX  
 QTY: 0123456789 HUE: XXXXXXXXXXX  
 CAT: XXXXXXXXXXX REF: XXXXXXXXXXX  
 REFERENCE: BTPYYMDDXXXX  
 MSL-X MADE IN XXXXXX



- CPN: Customer's Product Number
- P/N: Everlight Product Number
- LOT NO: Lot Number
- QTY: Packing Quantity
- CAT: Luminous Flux (Brightness) Bin
- HUE: Color Bin
- REF: Forward Voltage Bin
- REFERENCE: Reference
- MSL-X: MSL Level

### Carrier Tape Dimensions: Loaded Quantity 2000 pcs Per Reel (Minimum Package Quantity :1000 PCS)

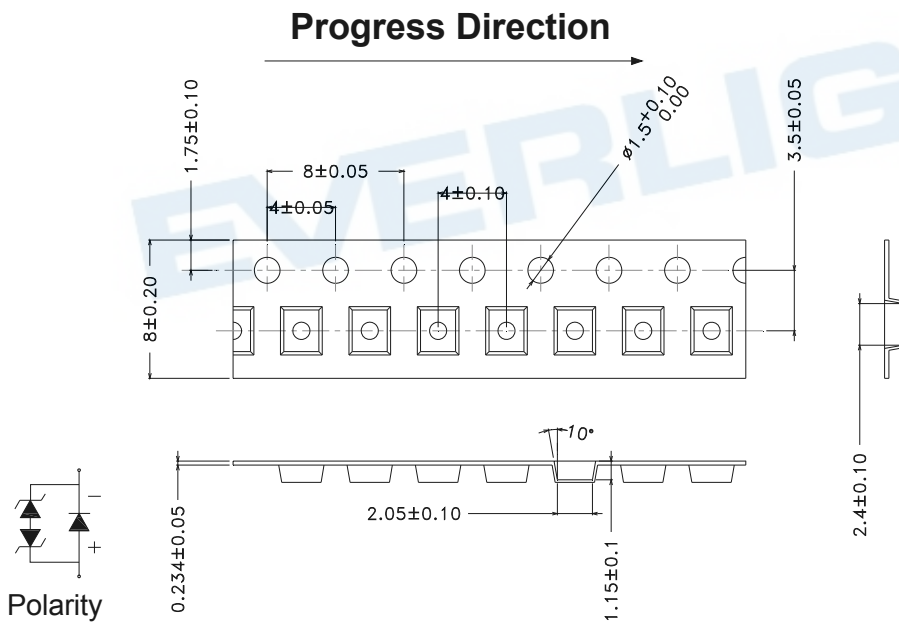

#### Notes:

1. Dimensions are in millimeters.

### Emitter Reel Dimensions

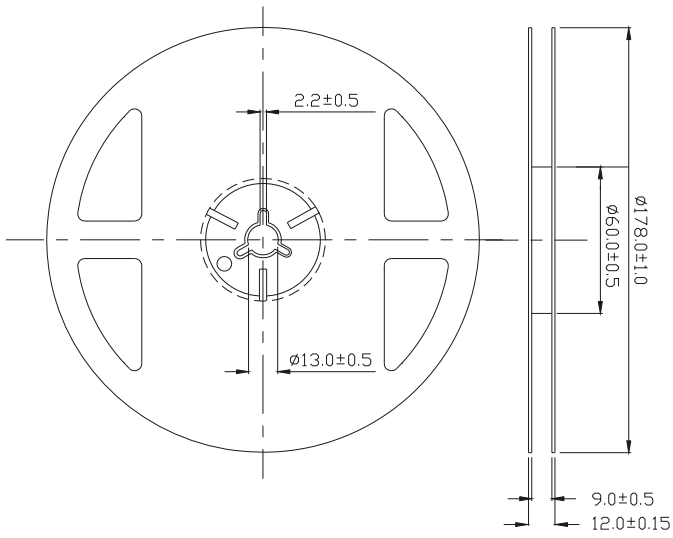

#### Notes:

1. Dimensions are in millimeters.

### Moisture Resistant Packing Process

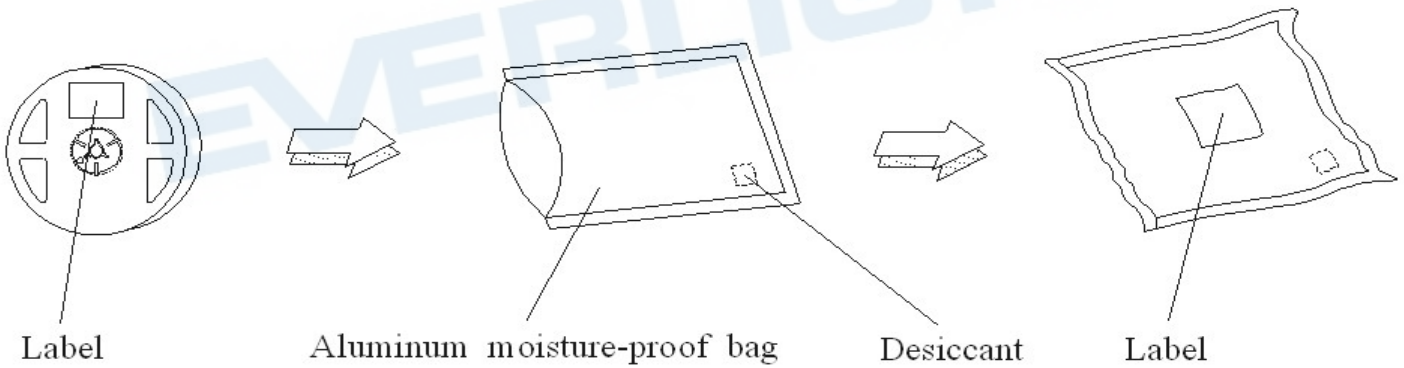

## Reflow Soldering Characteristics

### Soldering and Handling

#### 1. Over-current-proof

Though CHIN series has conducted ESD protection mechanism, customers must not use the device in reverse and should apply resistors for extra protection. Otherwise, slight voltage shift may cause enormous current shift and burn out failure would happen.

#### 2. Storage

- 2.1 Do not open the moisture proof bag before the products are ready to use.
- 2.2 Before opening the package, the LEDs should be stored at temperature less than 30°C and relative humidity less than 90%
- 2.3 After opening the package, the LEDs should be stored at temperature less than 30°C and relative humidity less than 85%.
- 2.4 If the moisture absorbent material (silicone gel) has faded away or the LEDs have exceeded the storage time, baking treatment should be implemented based on the following conditions: Pre-curing at 60±5°C for 24 hours.

#### 3. Thermal Management

- 3.1 For maintaining the high flux output and achieving reliability, Chin series LEDs should be mounted on a metal core printed circuit board (MCPCB), with proper thermal connection to dissipate approximately 1W to 5W of thermal energy under normal operation.
- 3.2 Sufficient thermal management must be conducted, or the die junction temperature will be over the limit under large electronic driving and LEDs lifetime will decrease critically.
- 3.3 When operating, the solder pad temperature (or the board temperature nearby the LED) must be controlled under 70°C.

#### 4. Soldering Condition

##### 4.1 Soldering Pad

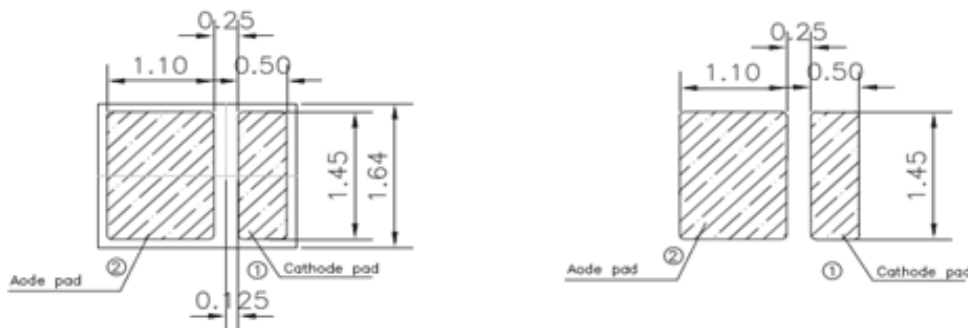

Component bottom view

Recommended soldering pattern layout

11

#### 4.2 For Reflow Process

##### 4.2.1 Lead reflow soldering temperature profile

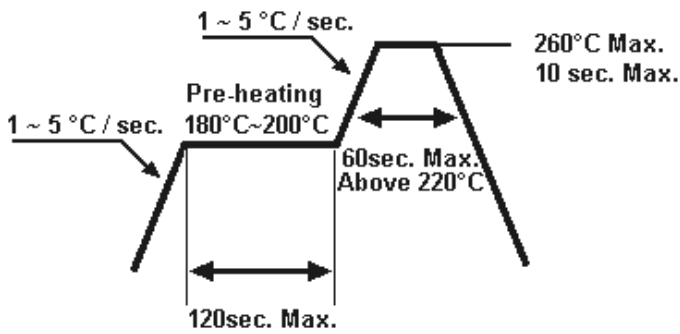

4.2.2 Reflow soldering should not be done more than two times.

4.2.3 While soldering, do not put stress on the LEDs during heating.

4.2.4 After soldering, do not warp the circuit board.

EVERLIGHT

## DISCLAIMER

1. EVERLIGHT reserves the right(s) on the adjustment of product material mix for the specification.
2. The product meets EVERLIGHT published specification for a period of twelve (12) months from date of shipment.
3. The graphs shown in this datasheet are representing typical data only and do not show guaranteed values.
4. When using this product, please observe the absolute maximum ratings and the instructions for using outlined in these specification sheets. EVERLIGHT assumes no responsibility for any damage resulting from the use of the product which does not comply with the absolute maximum ratings and the instructions included in these specification sheets.
5. These specification sheets include materials protected under copyright of EVERLIGHT. Reproduction in any form is prohibited without obtaining EVERLIGHT's prior consent.
6. This product is not intended to be used for military, aircraft, automotive, medical, life sustaining or life saving applications or any other application which can result in human injury or death. Please contact authorized Everlight sales agent for special application request.

EVERLIGHT

单击下面可查看定价，库存，交付和生命周期等信息

[>>Everlight \(亿光\)](#)