

FC20470210 .Common and differential mode suppression Inductors

1. Characteristics /特性:

1. Isolation Voltage /绝缘电压: 1875VAC for 1 second
2. Safety Detail /安规: Designed for UL1993 US Lighting
3. Standards Detail /标准: Designed to meet UL Insulation System
4. Operating Temp /操作温度: -40°C to +125°C
5. Common and differential mode suppression Inductors /共模和差模抑制电感
6. High differential mode inductance with low resistance /高差模电感低电阻
7. Extremely compact design /非常紧密设计
8. Reduces components needed /减少所需元件
9. Small PCB footprint /PCB占用空间小



3. Applications /应用:

1. Power tools /电动工具
2. CCFL/LED lighting / CCFL/LED照明
3. White goods /大型家用电器
4. Power electronics /电力电子设备
5. Electronics ballasts /电子镇流器
6. Offline switching power /离线开关电源
7. Filtering on device with unstable ground .
8. Power line input and output filters.

2. Common Mode And Differential Mode interference

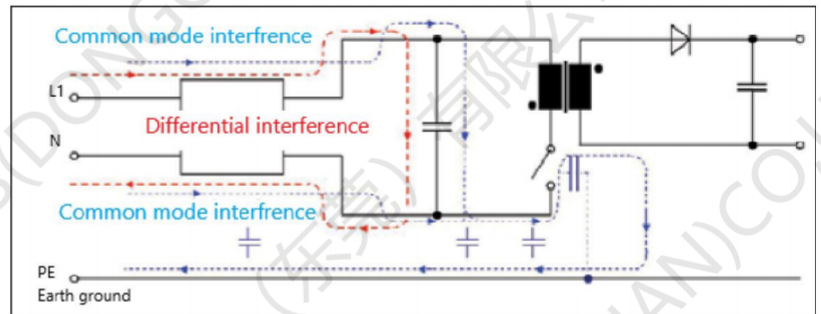

4. Impedance Common Mode/共模阻抗

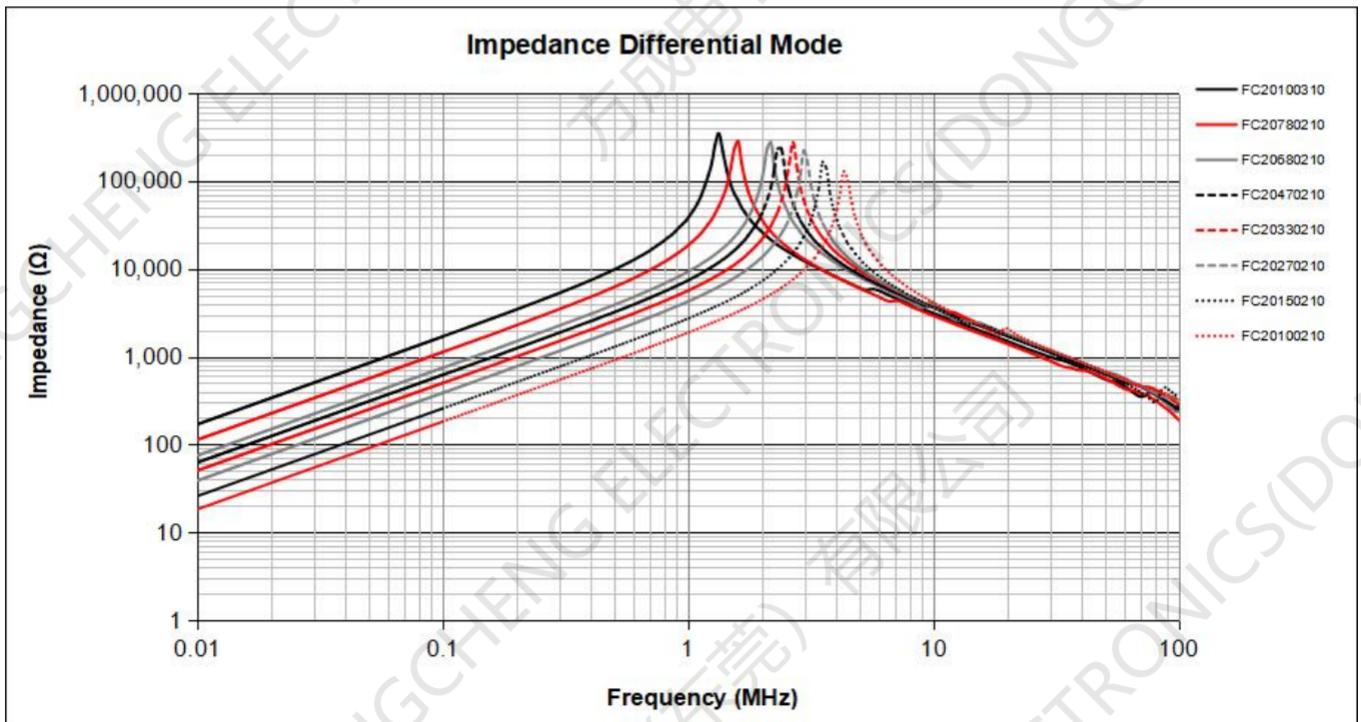

FC20470210 .Common and differential mode suppression Inductors

5. Dimensions: mm

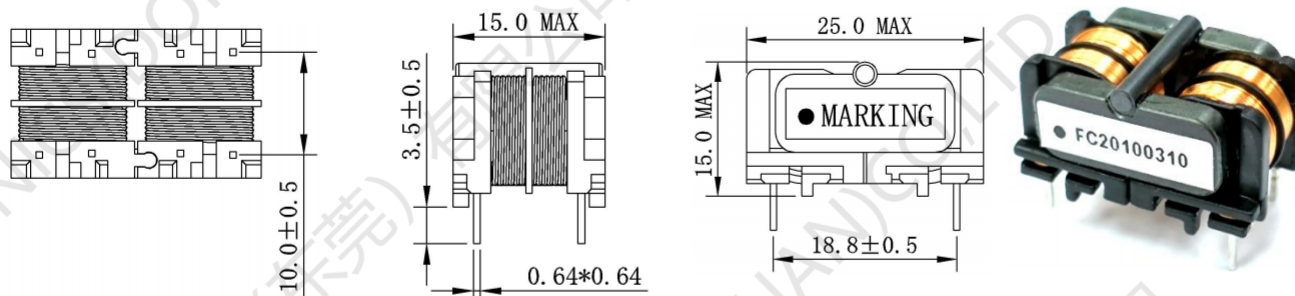

6. Schematic:

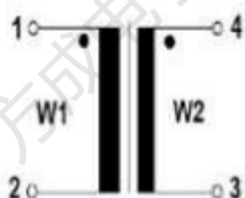

7. Recommended Land Pattern: mm

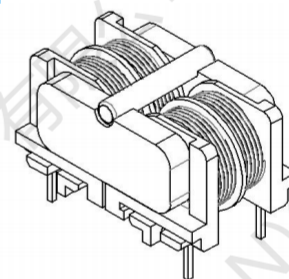
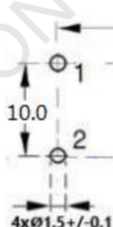

8. Electrical Properties: (specified @25°C if not mentioned otherwise *) typical value

All values without tolerances are typical values. Inductance and Lstray test condition **10KHz/50mV**

NO.	FC Ordering Code	Inductance(mH) +50%/-30%	I _r (A)	Lstray,typ (µH)	DCR (Ω) Type	DCR (Ω) Max
1	FC20100310	100	0.5	5770	2.90	3.87
2	FC20780210	78	0.61	4100	1.96	2.57
3	FC20680210	68	0.64	3500	1.80	2.38
4	FC20470210	47	0.75	2700	1.28	1.67
5	FC20390210	39	0.85	2100	1.10	1.60
6	FC20330210	33	0.98	1680	0.76	1.01
7	FC20150210	15	1.45	795	0.38	0.52
8	FC20100210	10	1.85	470	0.23	0.32
9	FC20330110	3.3	2.5	85	0.16	0.21

Hi-Pot: Windings to Core:1500Vac/50Hz 1.0mA 2S, W1 to W2, 2500Vac, 50Hz 1.0mA 2S,

Rated Voltage: 85-265Vac

Ambient temperature : -40°C to +85°C

Operating temperature: -40°C to +125°C

单击下面可查看定价，库存，交付和生命周期等信息

[>>FC\(方成\)](#)