

## ■ 車規厚膜片式固定電阻器

### Thick Film Chip Fixed Resistor Automotive Grade

#### ● 特點 Features

- \* 符合AEC-Q200汽車標準相關條款  
Compliant with AEC-Q200 standard
- \* 體積小、重量輕  
Miniature and light weight
- \* 適應再流焊與波峰焊  
Suit for reflow and wave flow solder
- \* 電性能穩定，可靠性高  
Stable electrical capability, high reliability
- \* 裝配成本低，并與自動貼裝設備匹配  
Low assembly cost, suit for automatic SMT equipment
- \* 機械强度高、高頻特性優越  
Superior mechanical and frequency characteristics
- \* 具有良好的抗硫化能力  
With good sulfuration-resistant performance
- \* 符合RoHS指令要求  
Compliant with RoHS directive
- \* 符合無鹵素要求  
Halogen free requirement



#### ● 品名構成 Type Designation

AC	D	03	K	1003	F	T			
<b>產品代號</b> Product Code	<b>額定功率代號</b> Rated Power Code		<b>電阻溫度系數代號</b> T.C.R Code		<b>電阻值代號</b> Resistance Value Code	<b>電阻值誤差精度代號</b> Resistance Tolerance Code	<b>包裝方式代號</b> Packaging Style Code		
車規厚膜片式固定電阻器 Thick Film Chip Fixed Resistor Automotive Grade	代號 Code	額定功率 Rated Power	代號 Code	型號 Type	型號 Type	代號 Code	誤差精度 Tolerance	代號 Code	包裝方法 Packaging Style
	C	1/16W	02	0402	0402 0603 0805 1206 1210 2010 2512	K	±100		T
	D	1/10W	03	0603		L	±250		
	E	1/8W	05	0805					
	F	1/4W	06	1206					
	R	1/3W	1210	1210					C
	H	3/4W	10	2010					
	J	1W	12	2512					
					跨接電阻 Chip Jumper	無表示 No Marking			
				三位數(E-24系列): 前兩位表示有效數字, 第三位表示有效數字后零的個數。 Three digits (E-24 series): The first two digits are significant figures and the third one denotes number of zeros. 四位數(E-96系列): 前三位表示有效數字, 第四位表示有效數字后零的個數。 Four digits (E-96 series): The first three digits are Significant figures and the four one denotes number of zeros. 小數點用R表示。Decimal point should be expressed by "R". 例如 Example: 103 = 10KΩ (E-24) 1003 = 100KΩ (E-96) 1R0 = 1.0Ω (E-24) 000 = 0Ω					
							跨接電阻 Chip Jumper	F ≤10mΩ G ≤20mΩ J ≤50mΩ	

# 車規厚膜片式固定電阻器

THICK FILM CHIP FIXED RESISTOR AUTOMOTIVE GRADE

## ● 結構 Construction

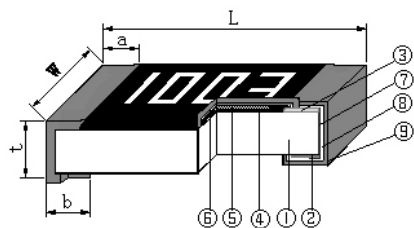

- ① 陶瓷基板 Ceramic Substrate
- ② 背電極 Bottom Electrode
- ③ 面電極 Top Electrode
- ④ 電阻體 Resistor Layer
- ⑤ 一次保護 Primary Overcoat
- ⑥ 二次保護 Secondary Overcoat
- ⑦ 端電極 Edge Electrode
- ⑧ 中間電極 Barrier Layer
- ⑨ 外部電極 External Electrode

## ● 規格尺寸 Dimensions

型號 Type	尺寸 Dimensions (mm)				
	L	W	t	a	b
0402	1.00±0.10	0.50±0.10	0.35±0.10	0.25±0.15	0.25±0.10
0603	1.60±0.15	0.80±0.15	0.45±0.10	0.30±0.20	0.30±0.20
0805	2.00±0.20	1.25±0.15	0.55±0.10	0.30±0.20	0.40±0.20
1206	3.20±0.20	1.60±0.15	0.55±0.10	0.35±0.20	0.50±0.20
1210	3.20±0.20	2.50±0.20	0.55±0.10	0.35±0.20	0.50±0.20
2010	5.00±0.20	2.50±0.20	0.55±0.10	0.40±0.20	0.60±0.20
2512	6.40±0.20	3.20±0.20	0.55±0.10	0.40±0.20	0.60±0.20

## ● 負荷下降曲線 Derating Curve

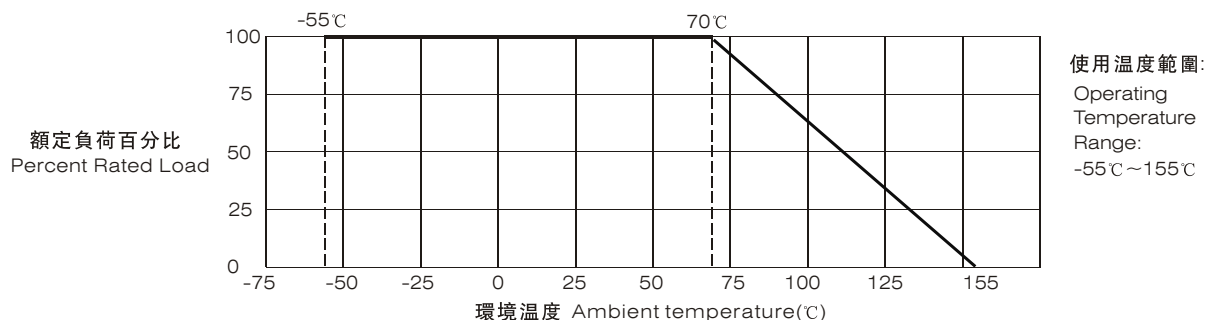

注：當電阻使用的環境溫度超過70°C時，其額定負荷(額定功率或額定電流)按上述曲線下降。

Note: For resistors operated in ambient over 70°C, rated load (rated power or rated current) shall be derated in accordance with the above figure.

## ● 額定值 Ratings

型號 Type	70°C下額定功率 Rated Power at 70°C (W)	元件極限電壓 Limiting Element Voltage (V)	最大過負荷電壓 Max. Overload Voltage (V)	跨接電阻70°C下 額定電流 Rated Current for Chip Jumper at 70°C (A)	跨接電阻 最大過負荷電流 Max. Overload Current for Chip Jumper (A)
0402	1/16	50	100	1	2
0603	1/10	50	100	1	3
0805	1/8	150	300	2	5
1206	1/4	200	400	2	5
1210	1/3	200	400	2	5
2010	3/4	200	400	2	5
2512	1	200	400	2	5

注  
Note

- 1、電壓、電流為直流或交流有效值。  
Voltage of DC or AC RMS value.
  - 2、 $E = \sqrt{P \times R}$  或元件極限電壓兩者中的較小值。  
 $E = \sqrt{P \times R}$  or Limiting element voltage whichever is lower.
- E: 額定電壓 Rated voltage(V)  
P: 額定功率 Rated power(W)  
R: 標稱阻值 Normal resistance(Ω)

### ● 額定值 Ratings

型號 Type	阻值範圍 Resistance Range	電阻溫度系數 T.C.R (ppm/°C)				
		標稱阻值允許偏差 Resistance Tolerance				
		± 0.5%	± 1%	± 2%	± 5%	± 10%
0402 0603 0805	1Ω < R < 10Ω	/	± 250	± 250	± 250	± 250
1206 1210 2010	10Ω < R < 1MΩ	± 100	± 100	± 100	± 100	± 100
2512	1MΩ < R < 10MΩ	/	± 250	± 250	± 250	± 250

### ● 特性 Characteristics

項目 Item	標準 Specifications		測試方法 Test Methods
	片式電阻器 Resistor	跨接電阻 Jumper	
高溫存儲 High Temperature Exposure (Storage)	無可見損傷 No mechanical damage 0.5%、1%: $\Delta R \leq \pm (1.0\%R + 0.05\Omega)$ 2%、5%、10%: $\Delta R \leq \pm (2.0\%R + 0.05\Omega)$	無可見損傷 No mechanical damage $R \leq 100 \text{ m}\Omega$ (J級) $R \leq 40 \text{ m}\Omega$ (G級) $R \leq 20 \text{ m}\Omega$ (F級)	AEC-Q200 Test 3/MIL-STD-202 Method 108 1000小時 @ T=125°C, 不通電。 1000 h @ T=125°C, Unpowered
溫度循環 Temperature Cycling	無可見損傷 No mechanical damage 0.5%、1%: $\Delta R \leq \pm (0.5\%R + 0.05\Omega)$ 2%、5%、10%: $\Delta R \leq \pm (1.0\%R + 0.05\Omega)$	無可見損傷 No mechanical damage $R \leq 100 \text{ m}\Omega$ (J級) $R \leq 40 \text{ m}\Omega$ (G級) $R \leq 20 \text{ m}\Omega$ (F級)	AEC-Q200 Test 4/JESD22 Method JA-104 -55°C (30分鐘) ~ 常溫(≤ 1分鐘) ~ 125°C (30分鐘), 1000個循環; -55°C (30min) ~ normal temperature (≤ 1min) ~ 125°C (30min), 1000 cycles;
高溫高濕 Biased Humidity	無可見損傷 No mechanical damage $\Delta R \leq \pm (3.0\%R + 0.05\Omega)$	無可見損傷 No mechanical damage $R \leq 100 \text{ m}\Omega$ (J級) $R \leq 40 \text{ m}\Omega$ (G級) $R \leq 20 \text{ m}\Omega$ (F級)	AEC-Q200 Test 7/MIL-STD-202 Method 103 溫度85°C, 濕度85%的條件下施加10%額定功率(電流)下的電壓值或元件極限電壓(取較小值), 放置1000小時。 85°C/85%RH. 1000 hours, Apply 10% of operating power (current) or limiting element voltage whichever is lower.
工作壽命 Operational Life	無可見損傷 No mechanical damage 0.5%、1%: $\Delta R \leq \pm (1.0\%R + 0.05\Omega)$ 2%、5%、10%: $\Delta R \leq \pm (3.0\%R + 0.05\Omega)$	無可見損傷 No mechanical damage $R \leq 100 \text{ m}\Omega$ (J級) $R \leq 40 \text{ m}\Omega$ (G級) $R \leq 20 \text{ m}\Omega$ (F級)	AEC-Q200 Test 8/MIL-STD-202 Method 108 125°C ± 2°C, 1000小時, 額定電壓(電流)或元件極限電壓(取較小值), 通1.5小時/斷0.5小時。 125°C ± 2°C, 1000h, rated voltage (current) or limiting element voltage whichever is lower for 1.5h ON/0.5h OFF.
耐溶劑性 Resistance to Solvents	標志清晰, 無可見損傷 Clearly marked, No mechanical damage		AEC-Q200 Test 12/MIL-STD-202 Method 215 浸在三種溶劑3min后擦拭10次, 浸、刷共3回來, 用水清洗劑進行清洗, 並且室溫下對整個表面進行通風干燥。 Immersed in three solvents after 3min immersion, brush wipe 10 times, a total of 3 times, washing with washing and cleaning agent, room temperature on the surface of the ventilation drying.
機械衝擊 Mechanical Shock	無可見損傷 No mechanical damage $\Delta R \leq \pm (1.0\%R + 0.05\Omega)$	無可見損傷 No mechanical damage $R \leq 50 \text{ m}\Omega$ (J級) $R \leq 20 \text{ m}\Omega$ (G級) $R \leq 10 \text{ m}\Omega$ (F級)	AEC-Q200 Test 13/MIL-STD-202 Method 213 正半弦波, 峰值加速度: 100g' s, 脈衝持續時間: 6ms, 三軸六向各3次, 共18次。 Positive half wave, peak acceleration: 100g' s, pulse duration: 6ms, three axis six to each 3 times, a total of 18 times.
振動 Vibration	無可見損傷 No mechanical damage $\Delta R \leq \pm (1.0\%R + 0.05\Omega)$	無可見損傷 No mechanical damage $R \leq 50 \text{ m}\Omega$ (J級) $R \leq 20 \text{ m}\Omega$ (G級) $R \leq 10 \text{ m}\Omega$ (F級)	AEC-Q200 Test 14/MIL-STD-202 Method 204 頻率: 10Hz~2000Hz, 加速度: 5g' s, 一個循環20min, X、Y、Z三個方向每個方向12個循環, 共36個循環。 Frequency: 10Hz ~ 2000Hz, acceleration: 5g' s, a loop 20min, X, Y, Z three directions, each direction 12 cycles, 36 cycles.
耐焊接熱 Resistance to Soldering Heat	無可見損傷 No mechanical damage 0.5%、1%: $\Delta R \leq \pm (0.5\%R + 0.05\Omega)$ 2%、5%、10%: $\Delta R \leq \pm (1.0\%R + 0.05\Omega)$	無可見損傷 No mechanical damage $R \leq 50 \text{ m}\Omega$ (J級) $R \leq 20 \text{ m}\Omega$ (G級) $R \leq 10 \text{ m}\Omega$ (F級)	AEC-Q200 Test 15/MIL-STD-202 Method 210 270°C ± 5°C 錫槽, 保持10s ± 1s。 Lead-free solder bath at 270°C ± 5°C for 10s ± 1s.

# 車規厚膜片式固定電阻器

THICK FILM CHIP FIXED RESISTOR AUTOMOTIVE GRADE

## ● 特性 Characteristics

( 續上頁 Continue )

項目 Item	標準 Specifications		測試方法 Test Methods
	片式電阻器 Resistor	跨接電阻 Jumper	
熱衝擊 Thermal Shock	無可見損傷 No mechanical damage 0.5%、1%: $\Delta R \leq \pm(0.5\%R+0.05\Omega)$ 2%、5%、10%: $\Delta R \leq \pm(1.0\%R+0.05\Omega)$	無可見損傷 No mechanical damage $R \leq 50\text{ m}\Omega$ (J級) $R \leq 20\text{ m}\Omega$ (G級) $R \leq 10\text{ m}\Omega$ (F級)	AEC-Q200 Test 16/MIL-STD-202 Method 107 -55°C(15分鐘)~常溫( $\leq 20$ 秒)~155°C(15分鐘), 300個循環。 1206: -55°C(15min)~normal temperature( $\leq 20$ s)~155°C(15min), 300 cycles.
ESD 靜電放電 Electrostatic Discharge (ESD)	無可見損傷 No mechanical damage $\Delta R \leq \pm(3.0\%R+0.05\Omega)$	無可見損傷 No mechanical damage $R \leq 50\text{ m}\Omega$ (J級) $R \leq 20\text{ m}\Omega$ (G級) $R \leq 10\text{ m}\Omega$ (F級)	AEC-Q200 Test 17/AEC-Q200-002 人體模式, 兩次放電, 正、負極性各1次。 Human body model, 1pos + 1neg discharges. 0402/0603: 1KV; 0805: 2KV; 1206及以上: 3KV
可焊性 Solderability	無可見損傷 No mechanical damage 可焊面積 $\geq 95\%$ 95% Cover Min		AEC-Q200 Test 18/IEC 60115-1 4.17 245°C $\pm 5$ °C 錫槽, 保持3s $\pm 0.3$ s. Lead-free solder bath at 245°C $\pm 5$ °C for 3s $\pm 0.3$ s.
電阻溫度系數 T.C.R	在規定值內 Within specified T.C.R	/	AEC-Q200 Test 19/IEC 60115-1 4.8 +20°C/-55°C/+20°C/+125°C/+20°C
可燃性 Flammability	不完全燃盡, 薄墊紙應不被引燃, 松木板應不被烤焦炭化。 No ignition of the tissue paper or scorching or the pinewood board.		AEC-Q200 Test 20/UL-94 V-0或V-1可接受。不需要電氣測試。 V-0 or V-1 are acceptable. Electrical test not required.
基板彎曲試驗 Substrate Bending Test	無可見損傷 No mechanical damage 0.5%、1%: $\Delta R \leq \pm(0.5\%R+0.05\Omega)$ 2%、5%、10%: $\Delta R \leq \pm(1.0\%R+0.05\Omega)$	無可見損傷 No mechanical damage $R \leq 50\text{ m}\Omega$ (J級) $R \leq 20\text{ m}\Omega$ (G級) $R \leq 10\text{ m}\Omega$ (F級)	AEC-Q200 Test 21/AEC-Q200-005 彎曲距離(Bending distance): 0402、0603、0805: 5mm; 1206、1210:4mm; 2010、2512:2mm 保持時間(Duration): 60s $\pm 5$ s
端子強度 Terminal Strength	無可見損傷 No mechanical damage 0.5%、1%: $\Delta R \leq \pm(0.5\%R+0.05\Omega)$ 2%、5%、10%: $\Delta R \leq \pm(1.0\%R+0.05\Omega)$	無可見損傷 No mechanical damage $R \leq 50\text{ m}\Omega$ (J級) $R \leq 20\text{ m}\Omega$ (G級) $R \leq 10\text{ m}\Omega$ (F級)	AEC-Q200 Test 22/AEC-Q200-006 施加力: 17.7N, 保持60 $\pm 1$ 秒。 Applying force 17.7N for 60s $\pm 1$ s.
阻燃性 Flame Retardance	不可燃 No flame		AEC-Q200 Test 24/AEC-Q200-001 9Vdc 到 32Vdc( 鉗位電流高達 500A )、增量為 1.0Vdc 的電壓。 每種電壓等級最少施加1小時。 Subjected to voltage from 9.0 to 32.0 VDC(current clamped up to 500A), and each voltage level shall be increased in 1.0 VDC for one hour minimum.
絕緣電阻 Insulation Resistance	1000M $\Omega$ Min		IEC 60115-1 4.6 在電極與基片間施加100V $\pm 15$ V直流電壓, 保持1分鐘, 然後測絕緣電阻值。 Apply DC 100V $\pm 15$ V between substrate and terminations for 1min, then check insulation resistance.
耐電壓 Voltage Proof	無擊穿或飛弧 No breakdown or flashover		IEC 60115-1 4.7 在電極與基片間以大約100V/s的速率施加有效值為最大過負荷電壓的交流電壓, 保持60s $\pm 5$ s。 Apply max. overload voltage of AC RMS at a rate of approximately 100V/s between substrate and terminations for 60s $\pm 5$ s.
短時間過負載 Short Time Overload	無可見損傷 No mechanical damage 0.5%、1%: $\Delta R \leq \pm(1.0\%R+0.05\Omega)$ 2%、5%、10%: $\Delta R \leq \pm(2.0\%R+0.05\Omega)$	無可見損傷 No mechanical damage $R \leq 50\text{ m}\Omega$ (J級) $R \leq 20\text{ m}\Omega$ (G級) $R \leq 10\text{ m}\Omega$ (F級)	IEC 60115-1 4.13 2.5倍額定電壓或最大過負荷電壓/電流(取較小值), 持續5秒。 2.5 times rated voltage or max. overload voltage(current) whichever is lower for 5s.
低溫負載 Operation at Low Temperature	無可見損傷 No mechanical damage 0.5%、1%: $\Delta R \leq \pm(1.0\%R+0.05\Omega)$ 2%、5%、10%: $\Delta R \leq \pm(2.0\%R+0.05\Omega)$	無可見損傷 No mechanical damage $R \leq 50\text{ m}\Omega$ (J級) $R \leq 20\text{ m}\Omega$ (G級) $R \leq 10\text{ m}\Omega$ (F級)	IEC 60115-1 4.36 -55°C $\pm 5$ °C, 無負載1小時, 額定電壓(電流)或元件極限電壓(取較小值)45分鐘, 無負載15分鐘。 -55°C $\pm 5$ °C, 1h without load, rated voltage(current) or limiting element voltage whichever is lower for 45min, 15min without load.

• **特性 Characteristics**

( 續上頁 Continue)

項目 Item	標準 Specifications		測試方法 Test Methods
	片式電阻器 Resistor	跨接電阻 Jumper	
抗硫化性能 Sulfuration Resistant	無可見損傷 No mechanical damage $\Delta R \leq \pm(5.0\%R + 0.05\Omega)$	無可見損傷 No mechanical damage $R \leq 100\text{ m}\Omega$ (J級) $R \leq 40\text{ m}\Omega$ (G級) $R \leq 20\text{ m}\Omega$ (F級)	切削油：硫磺粉，恒溫： $105^\circ\text{C} \pm 3^\circ\text{C}$ ，放置時間：500小時 Cutting oil: sulphur power, constant temperature: $105^\circ\text{C} \pm 3^\circ\text{C}$ , for 500hrs.

• **包裝 Packaging**

包裝方式見附錄1 ~ 9頁      Packaging see the appendix 1-9 Page .

### ■ 推薦焊盤尺寸 Recommend Solder Pad Size

- 片式固定電阻器 Chip fixed resistor

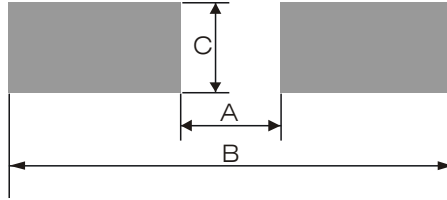

單位 unit: mm

厚膜電阻及薄膜電阻 Thick Film Resistor and Thin Film Resistor			
型號Type	A	B	C
01005	0.17	0.60	0.22
0201	0.23	0.84	0.38
0402	0.45	1.45	0.60
0603	0.80	2.50	0.95
0805	1.05	3.25	1.40
1206	1.90	4.50	1.75
1210	2.00	4.60	2.70
2010	3.50	6.50	2.70
2512	4.80	7.80	3.40

單位 unit: mm

合金片式固定電阻 Metal Foil Resistor				
型號Type	阻值(mΩ)	A	B	C
0603	R003~R004	0.4	2.8	1.0
	R005~R030	0.6		
0805	R003~R004	0.5	3.2	1.4
	R005~R047	0.8		
1206	R003~R004	0.8	4.4	1.8
	R005~R068	1.8		
2010	R003~R009	1.6	6.3	2.9
	R010~R100	2.7		
2512	R002~R004	1.0	8.0	3.4
	R005~R200	3.8		

- 厚膜片式網絡電阻器 Thick film chip network resistor

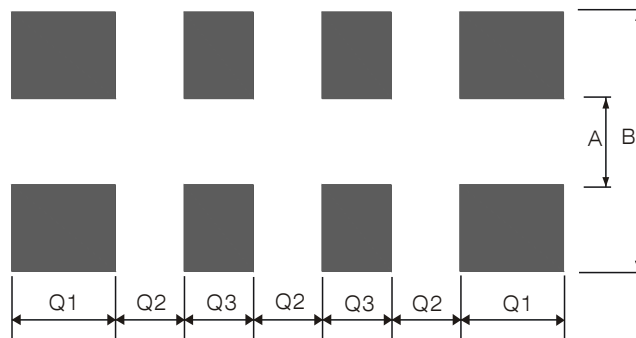

RCMY08 / RCMT08 / RCML08

單位 unit: mm

型號 Type	A	B	Q1	Q2	Q3
RCMY08	0.30	0.90	0.20	0.20	0.20
RCMT08	0.38	1.60	0.40	0.20	0.30
RCML08	0.80	2.70	0.60	0.40	0.40

## ■ 包装 Packaging

### ● 紙帶編帶 Paper Taping

適用於01005、0201、0402、RCMY08、RCMT08；  
 For 01005、0201、0402、RCMY08、RCMT08；

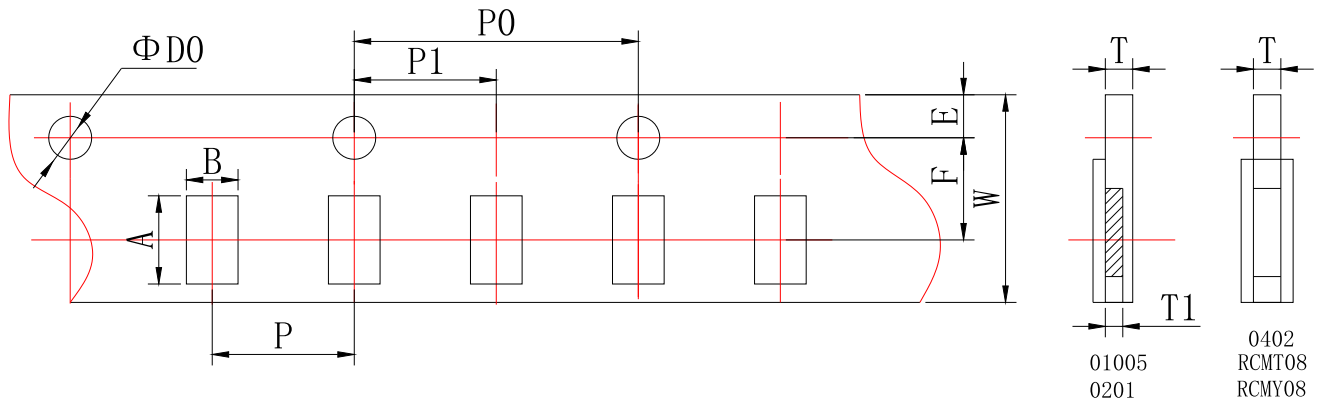

單位 unit: mm

型號 Type	A	B	W	F	E
01005	0.45±0.02	0.25±0.02	8.00±0.02	3.50±0.05	1.75±0.05
0201	0.70±0.10	0.40±0.10	8.00±0.20	3.50±0.05	1.75±0.10
0402	1.20±0.10	0.70±0.10	8.00±0.20	3.50±0.05	1.75±0.10
RCMY08	1.57±0.05	0.77±0.05	8.00±0.20	3.50±0.05	1.75±0.10
RCMT08	2.20±0.10	1.20±0.10	8.00±0.20	3.50±0.05	1.75±0.10

單位 unit: mm

型號 Type	P	P0	P1	ΦD0	T1	T
01005	2.00±0.05	4.00±0.10	2.00±0.05	1.55±0.02	0.17±0.02	0.31±0.02
0201	2.00±0.05	4.00±0.10	2.00±0.05	1.50±0.10	0.28±0.04	0.42±0.05
0402	2.00±0.05	4.00±0.10	2.00±0.05	1.50±0.10	/	0.42±0.05
RCMY08	2.00±0.05	4.00±0.10	2.00±0.05	1.50±0.10	/	0.60±0.10
RCMT08	2.00±0.10	4.00±0.10	2.00±0.05	1.50±0.10	/	0.60±0.10

適用於0603、0805、1206、1210、RCML08；  
 For 0603、0805、1206、1210、RCML08；

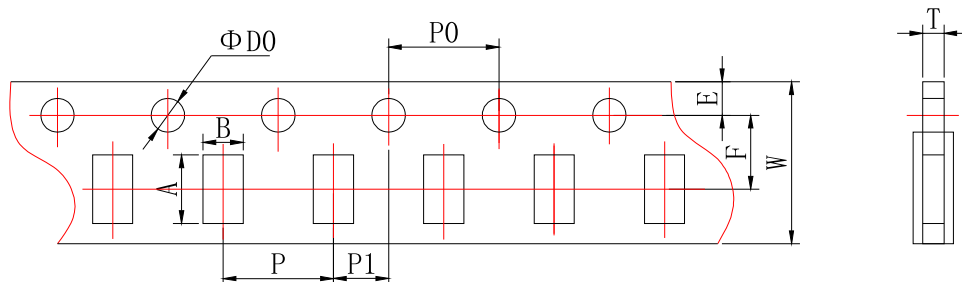

# 片式電阻包裝方式及注意事項

## PACKAGING AND PRECAUTION OF CHIP RESISTOR

單位 unit: mm

型號 Type	A	B	W	F	E
0603	$1.85 \pm 0.10$	$1.10 \pm 0.10$	$8.00 \pm 0.20$	$3.50 \pm 0.05$	$1.75 \pm 0.10$
0805	$2.35 \pm 0.10$	$1.65 \pm 0.10$	$8.00 \pm 0.20$	$3.50 \pm 0.05$	$1.75 \pm 0.10$
1206	$3.50 \pm 0.20$	$1.90 \pm 0.20$	$8.00 \pm 0.20$	$3.50 \pm 0.05$	$1.75 \pm 0.10$
1210	$3.50 \pm 0.20$	$2.80 \pm 0.20$	$8.00 \pm 0.20$	$3.50 \pm 0.05$	$1.75 \pm 0.10$
RCML08	$3.50 \pm 0.20$	$1.90 \pm 0.20$	$8.00 \pm 0.20$	$3.50 \pm 0.05$	$1.75 \pm 0.10$

單位 unit: mm

型號 Type	P	P0	P1	$\Phi D0$	T	
					厚膜電阻及薄膜電阻 Thick Film Resistor and Thin Film Resistor	合金片式固定電阻 Metal Foil Resistor
0603	$4.00 \pm 0.10$	$4.00 \pm 0.10$	$2.00 \pm 0.05$	$1.50 \pm 0.10$	$0.60 \pm 0.10$	$0.75 \pm 0.10$
0805	$4.00 \pm 0.10$	$4.00 \pm 0.10$	$2.00 \pm 0.05$	$1.50 \pm 0.10$	$0.75 \pm 0.10$	$0.95 \pm 0.10$
1206	$4.00 \pm 0.10$	$4.00 \pm 0.10$	$2.00 \pm 0.05$	$1.50 \pm 0.10$	$0.75 \pm 0.10$	$0.95 \pm 0.10$
1210	$4.00 \pm 0.10$	$4.00 \pm 0.10$	$2.00 \pm 0.05$	$1.50 \pm 0.10$	$0.75 \pm 0.10$	---
RCML08	$4.00 \pm 0.10$	$4.00 \pm 0.10$	$2.00 \pm 0.05$	$1.50 \pm 0.10$	$0.75 \pm 0.10$	---

### ● 塑料帶編帶 Embossed Taping

適用於2010、2512:

For 2010, 2512:

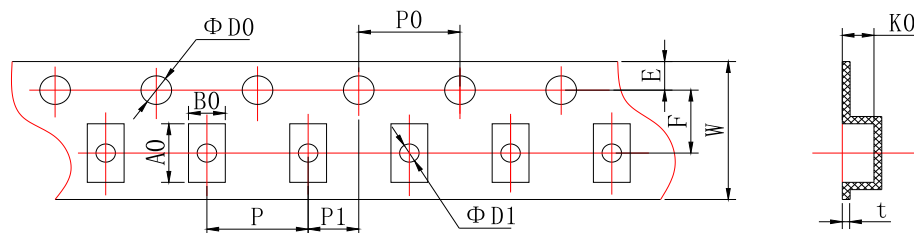

單位 unit: mm

型號 Type	A0	B0	W	F	E	t
2010	$5.50 \pm 0.15$	$2.82 \pm 0.15$	$12.00 \pm 0.10$	$5.50 \pm 0.10$	$1.75 \pm 0.10$	$0.25 \pm 0.05$
2512	$6.78 \pm 0.15$	$3.45 \pm 0.15$	$12.00 \pm 0.10$	$5.50 \pm 0.10$	$1.75 \pm 0.10$	$0.25 \pm 0.05$

單位 unit: mm

型號 Type	P	P0	P1	$\Phi D0$	$\Phi D1$	K0	
						厚膜電阻及薄膜電阻 Thick Film Resistor and Thin Film Resistor	合金片式固定電阻 Metal Foil Resistor
2010	$4.00 \pm 0.10$	$4.00 \pm 0.10$	$2.00 \pm 0.05$	$1.50 \pm 0.10 / -0$	$1.50 \pm 0.10$	$0.84 \pm 0.10$	$0.84 \pm 0.10$
2512	$4.00 \pm 0.10$	$4.00 \pm 0.10$	$2.00 \pm 0.05$	$1.50 \pm 0.10 / -0$	$1.50 \pm 0.10$	$0.81 \pm 0.10$	$1.00 \pm 0.10$



● 卷盤 Reel

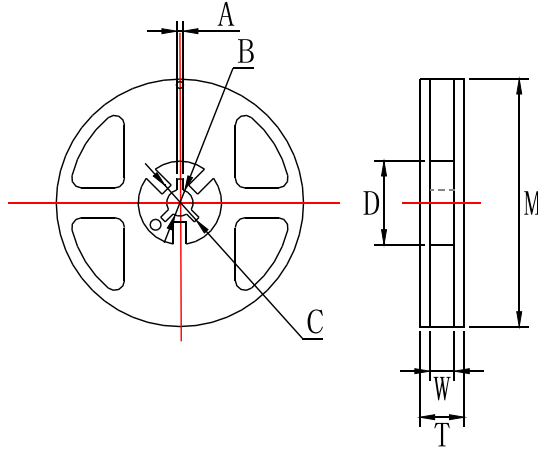

單位 unit: mm

型號 Type	M	W	T	A	B	C	D
01005、0201 0402、0603 0805、1206 1210、RCMY08、 RCMT08、RCML08	178±2.0	9.5±1.0	12.5±1.5	2.0±0.5	13.0±0.5	21.0±0.5	58.0±2.0
2010、2512	178±2.0	13.0±0.5	15.5±1.5	2.0±0.5	13.0±0.5	21.0±0.5	57.0±2.0

● 包裝數量 Packaging Quantity

包裝方法 Packaging style	編帶 Tape & reel				塑料袋散裝 Case		
型號 Type	01005	0201、0402 RCMY08、 RCMT08	0603、0805 1206、1210 RCML08	2010 2512	01005 0201 0402	0603、0805 1206、 RCMY08、RCMT08、 RCML08	1210 2010 2512
數量 Quantity(pcs)	20000	10000	5000	4000	≤50000	≤10000	≤4000

■ IEC E-24、E-96系列電阻值代碼對照表

IEC E-24、E-96 Series Resistance Cross-reference List

● E-24 系列 E-24 series( $\times 10^n \Omega$ )

(單位 unit: 0.001 $\Omega$ 、0.01 $\Omega$ 、0.1 $\Omega$ 、1 $\Omega$ 、10 $\Omega$ 、100 $\Omega$ 、1k $\Omega$ 、10k $\Omega$ 、100k $\Omega$ 、1M $\Omega$ 、10M $\Omega$ 、100M $\Omega$ 、1000M $\Omega$ )

1.0	1.5	2.2	3.3	4.7	6.8
1.1	1.6	2.4	3.6	5.1	7.5
1.2	1.8	2.7	3.9	5.6	8.2
1.3	2.0	3.0	4.3	6.2	9.1

# 片式電阻包裝方式及注意事項

## PACKAGING AND PRECAUTION OF CHIP RESISTOR

● E-96系列 E-96 series ( $\times 10^n\Omega$ )

(單位unit: 0.001 $\Omega$ , 0.01 $\Omega$ , 0.1 $\Omega$ , 1 $\Omega$ , 10 $\Omega$ , 100 $\Omega$ , 1k $\Omega$ , 10k $\Omega$ , 100k $\Omega$ , 1M $\Omega$ , 10M $\Omega$ , 100M $\Omega$ , 1000M $\Omega$ )

1.00	1.33	1.78	2.37	3.16	4.22	5.62	7.50
1.02	1.37	1.82	2.43	3.24	4.32	5.76	7.68
1.05	1.40	1.87	2.49	3.32	4.42	5.90	7.87
1.07	1.43	1.91	2.55	3.40	4.53	6.04	8.06
1.10	1.47	1.96	2.61	3.48	4.64	6.19	8.25
1.13	1.50	2.00	2.67	3.57	4.75	6.34	8.45
1.15	1.54	2.05	2.74	3.65	4.87	6.49	8.66
1.18	1.58	2.10	2.80	3.74	4.99	6.65	8.87
1.21	1.62	2.15	2.87	3.83	5.11	6.81	9.09
1.24	1.65	2.21	2.94	3.92	5.23	6.98	9.31
1.27	1.69	2.26	3.01	4.02	5.36	7.15	9.53
1.30	1.74	2.32	3.09	4.12	5.49	7.32	9.76

● E-96系列0603型號《乘數代碼對照表》及《電阻值代碼對照表》

E-96 series(0603)《multiplied Cross-reference List》and《Resistance Cross-reference List》

乘數multiplied	$\times 10^0$	$\times 10^1$	$\times 10^2$	$\times 10^3$	$\times 10^4$	$\times 10^5$	$\times 10^6$	$\times 10^7$	$\times 10^{-1}$	$\times 10^{-2}$	$\times 10^{-3}$
代碼 code	A	B	C	D	E	F	G	H	X	Y	Z

代號 Code	E-96系列電阻 E-96 resistance	代號 Code	E-96系列電阻 E-96 resistance	代號 Code	E-96系列電阻 E-96 resistance	代號 Code	E-96系列電阻 E-96 resistance
01	100	25	178	49	316	73	562
02	102	26	182	50	324	74	576
03	105	27	187	51	332	75	590
04	107	28	191	52	340	76	604
05	110	29	196	53	348	77	619
06	113	30	200	54	357	78	634
07	115	31	205	55	365	79	649
08	118	32	210	56	374	80	665
09	121	33	215	57	383	81	681
10	124	34	221	58	392	82	698
11	127	35	226	59	402	83	715
12	130	36	232	60	412	84	732
13	133	37	237	61	422	85	750
14	137	38	243	62	432	86	768
15	140	39	249	63	442	87	787
16	143	40	255	64	453	88	806
17	147	41	261	65	464	89	825
18	150	42	267	66	475	90	845
19	154	43	274	67	487	91	866
20	158	44	280	68	499	92	887
21	162	45	287	69	511	93	909
22	165	46	294	70	523	94	931
23	169	47	301	71	536	95	953
24	174	48	309	72	549	96	976

## ■ 厚膜电阻阻值代码及标记规则

### Description for Resistance Value Code and Marking of Thick Film Chip Resistor

- 阻值代码 Resistance Value Code



所有厚膜电阻的阻值代码与其标记是相对应的。

All the resistance value code of thick film chip resistor is corresponding with the marking .

- 标记 Marking

- \* E-24系列(0603、±5%)：采用三位数字表示，前二位表示电阻值有效数字，第三位表示乘以10的次方数。

E-24 series: Express resistance value on the glass side with three digits, the first two digits should be significant and the third one denote number of zeros.

例 For example:  → 30KΩ       → 33Ω

- \* E-24系列(0603、±1%&±0.5%)：在三位数字标记下方增加下横线识别。

E-24 series(0603、±1%&±0.5%): One short bar under marking letter.

例 For example: 

- \* E-96系列和E24系列(±1%&±0.5%)：

▲0805、1206、1210、2010、2512 采用四位数字表示，前三位表示电阻值有效数字，第四位表示乘以10的次方数。

E-96 series & E-24 series: For the dimension type of 0805、1206、1210、2010、2512 express the resistance value with four digits, the first three digits are significant figures and the fourth one notes the number of zeros.

例 For example:  → 100KΩ

- \* E-96系列：

▲0603用三位代码表示，前二位表示E-96系列阻值代码，后一位字母表示乘数代码(见表三和表四)。

For the dimension type of 0603, express the resistance value with three code, the first two digit code denote the resistance of E-96 series, and the third code of letter denote the multiplier (see the table three and four).

例 For example:  → 2MΩ

- \* 小数点以“R”表示 The decimal point should be expressed by “R” .

例 For example:  → 5.6Ω       → 1Ω

- \* 跨接电阻以“0”表示 The jumper should be expressed by “0”

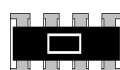
例 For example:  → 0Ω       → 0Ω

- \* 01005、0201、0402 不作标记 For the dimension type of 01005、0201、0402 there is no mark on the glass side.

例 For example: 

- \* 非IEC标准系列的电阻值标记表示方法：一般以最接近IEC E24系列标称阻值的标记表示方法。

For the resistance which don't belong to IEC serial, use the resistance of IEC serial which is most close to the required resistance of non-IEC serial for replacement.

- \* 客户对标记有特殊要求时，则按照协商的结果印刷标记。

To get agreement by both party if there special requirement for the marking.

### ■ 薄膜電阻阻值代碼及標記規則

#### Description for Resistance Value Code and Marking of Thin Film Chip Resistor

- 阻值代碼 Resistance Value Code

所有薄膜電阻包括 0201、0402、0603、0805、1206、1210、2010、2512 統一採用四位數阻值代碼表示。  
All resistance value code of thin film chip resistor, including 0201、0402、0603、0805、1206、1210、2010、2512 size used four digits.

例 Example

TD03G4701BT

四位數代號表示，如：4701=4.7KΩ；1R50=1.5Ω

To use four digits code represent resistance value,

例 Example 4701=4.7KΩ；1R50=1.5Ω

- 標記 Marking

- \* 當阻值同時存在於E24和E96系列時，優先採用E96系列。

When resistance value belongs to E24 as well as E96 series, we suggest preferentially use E96 series.

例 Example 10K=1002, ≠103

- \* 0805、1206、1210、2010、2512標記 Marking for 0805、1206、1210、2010、2512 Size Resistor

▲ 0805、1206、1210、2010、2512 印刷四位數字代碼；

For 0805、1206、1210、2010、2512 size resistor, express the resistance value with four digits code;

例 Example



- \* 0603標記 Marking for 0603 Size Resistor

▲ 0603-E96系列：印刷三位字母代碼；

For resistance value belongs to E96 series, express the resistance value with three digits code.

例 Example



▲ 0603-E24系列：印刷三位數字代碼，

For resistance value belongs to E24 series, express the resistance value with three digits code.

例 Example



- \* ▲ 小數點以"R"表示 The decimal point should be expressed by"R".

例 Example



- \* 0201、0402：不作標記 For the dimension type of 0201、0402 there is no mark on the glass side.

例 Example



## ■ 电流检测电阻阻值代码及标记规则

### Description for Resistance Value Code and Marking of Current Sensing Thick Film Chip Resistor

#### ● 阻值代码 Resistance Value Code

所有电流检测电阻包括 0402、0603、0805、1206、1210、2010、2512 统一采用四位数字阻值代码表示。  
 All resistance value code of current sensing thick film chip resistor, including 0402、0603、0805、1206、1210、2010、2512 size used four digits.

例 Example

RBF03MR010FT

四位数字代码表示，如：R010=10mΩ；30M1=30.1mΩ  
 To use four digits code represent resistance value,  
 例 Example R010=10mΩ；30M1=30.1mΩ

#### ● 标记 Marking

\* E-24和E-96系列(0805至2512，±5%、±1%、±0.5%)：采用四位标记代码。

For 0805、1206、1210、2010、2512, when resistance value belongs to E24 and E96 series, we suggest preferentially use four digits.

标记代码 Mark Code	阻值范围 Resistance Value	示例 Sample
R00X	$1\text{m}\Omega \leq R \leq 9\text{m}\Omega$	R005=5mΩ
R0XX	$10\text{m}\Omega \leq R \leq 99\text{m}\Omega$	R033=33mΩ
RXXX	$100\text{m}\Omega \leq R \leq 999\text{m}\Omega$	R100=100mΩ
XMXX	$1\text{m}\Omega < R < 10\text{m}\Omega$ (包含小数点后两位有效数字) (Contains two significant digits after the decimal point.)	5M10=5.1mΩ
XXMX	$10\text{m}\Omega < R < 100\text{m}\Omega$ (包含小数点后一位有效数字) (Contains one significant digit after the decimal point.)	30M1=30.1mΩ

\* E-24和E-96系列(0603，±5%、±1%、±0.5%)：采用三位标记代码。

For 0603, when resistance value belongs to E24 and E96 series, we suggest preferentially use three digits.

标记代码 Mark Code	阻值范围 Resistance Value Range	示例 Sample
V0X	$1\text{m}\Omega \leq R \leq 9\text{m}\Omega$	V05=5mΩ
VXX	$10\text{m}\Omega \leq R \leq 99\text{m}\Omega$	V33=33mΩ
RXX	$100\text{m}\Omega \leq R \leq 999\text{m}\Omega$	R100=100mΩ
XXM	$1\text{m}\Omega < R < 10\text{m}\Omega$ (包含小数点后一位有效数字) (Contains one significant digit after the decimal point.)	5M1=5.1mΩ

\* 0402及以下规格不印刷标记。

For 0402, there is no mark on the glass side.

\* 非IEC标准系列的电阻值标记表示方法：一般以最接近IEC E24系列标称阻值的标记表示方法。

For the resistance which don't belong to IEC serial, use the resistance of IEC serial which is most close to the required resistance of non-IEC serial for replacement.

\* 客户对标记有特殊要求时，则按照协商的结果印刷标记。

To get agreement by both party if there special requirement for the marking.

## ■ 片式電阻器使用說明 Chip Resistor Instructions for Use

### ● 本產品在以下特殊環境下應用，性能可能會受到影響：

- 1、在各種類型的液體，包括水、油、化學品、有機溶劑的使用。
- 2、在戶外直接暴露在陽光的地方，或在灰塵多的地方使用。
- 3、在產品暴露的地方，有海風或腐蝕性氣體，包括氯氣、硫化氫、氨氣、二氧化硫、二氧化氮等。
- 4、在產品暴露于靜電或電磁波的地方使用。
- 5、在產生熱量的部件、塑料綫，或其他易燃物品附近使用。
- 6、在用樹脂或其他塗層材料密封產品的情況下使用。
- 7、焊接后使用不潔焊料或使用水或水溶性清洗劑清洗產品。

### ● Application of the products in a special environment can deteriorate product performance:

- 1、Use in various types of liquid, including water, oils, chemicals, and organic solvents.
- 2、Use outdoors where the products are exposed to direct sunlight, or in dusty places.
- 3、Use in places where the products are exposed to sea winds or corrosive gases, including Cl<sub>2</sub>, H<sub>2</sub>S, NH<sub>3</sub>, SO<sub>2</sub>, and NO<sub>2</sub> etc.
- 4、Use in places where the products are exposed to static electricity or electromagnetic waves.
- 5、Use in proximity to heat-producing components, plastic cords, or other flammable items.
- 6、Use involving sealing or coating the products with resin or other coating materials.
- 7、Use involving unclean solder or use of water or water-soluble cleaning agents for cleaning after soldering.

### ● 產品使用注意事項

- 1、避免采用超過正常額定功率的功率，超過額定功率的穩態負載條件下可能會對產品性能和可靠性產生負面影響。
- 2、用鑷子拿起產品時要小心，有可能會將保護或電阻體夾碎。
- 3、手動安裝產品時，烙鐵頭勿觸碰產品。
- 4、貯存條件: 溫度5℃ ~ 30℃，相對濕度30% ~ 70%。

### ● Precautions on use of products

- 1、Avoid applying power exceeding normal rated power, exceeding the power rating under steady-state loading condition may negatively affect product performance and reliability.
- 2、Be careful when pick up the products with tweezers. There may be a care that the overcoat and / or the body can be chipped.
- 3、Soldering tip shall not touch the product when install product manually.
- 4、Storage conditions: T: 5℃ ~ 30℃, RH: 30% ~ 70%.

## ■ 焊接 Soldering

- 推薦的回流焊曲綫 Recommended reflow profile
- 推薦的波峰焊曲綫 Recommended wave solder profile

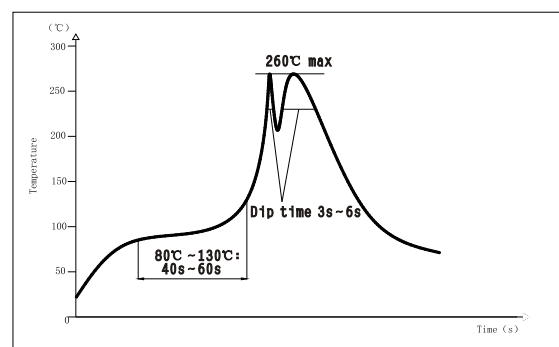
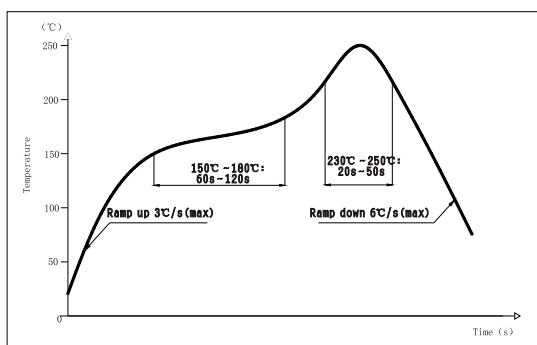

- 推薦的焊膏類型 Recommended solder alloy: 96.5Sn/3.0Ag/0.5Cu

单击下面可查看定价，库存，交付和生命周期等信息

[>>FH\(风华高科\)](#)