

■ **描述 DESCRIPTIONS**

SOT-23 塑封封装二极管。Diode in a SOT-23 Plastic Package.

■ **应用 APPLICATIONS**

开关应用。Switching Applications.

■ **引脚说明 PIN ASSIGNMENT**

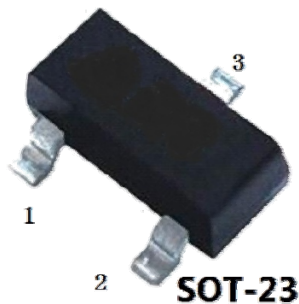

- 1 Anode
- 2 Cathode
- 3 Cathode/Anode

■ **内部等效电路 Equivalent Circuit**

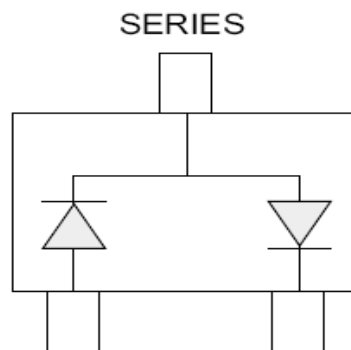

■ **型号构成 Name rule**

基本名称 Name			辅助识别代码 Additional code			
第一部分 Part 1	第二部分 Part 2	第三部分 Part 3	第四部分 Part 4	第五部分 Part 5	第六部分 Part 6	第七部分 Part 7
品牌 Brand	产品类别 Type	产品型号 Model	分档 Value	分隔号 Separatrix	封装代码 Package	附加码 (备用) Extra-code
FH	D : 二极管	99		"_"	M: SOT23	E : ROHS

■ 额定值 ABSOLUTE MAXIMUM RATINGS (TC=25°C unless otherwise noted)

特性参数 CHARACTERISTIC	符号 SYMBOL	额定值 RATING	单位 UNIT
反向电压 Reverse Voltage	V_R	70	V
平均正向电流 Mean Forward Current	I_O	200	mA
正向不重复峰值电流 Non-Repetitive Peak Forward Surge Current Pulse width=1.0 second Pulse width=1.0 microsecond	I_{FSM}	1.0 2.0	A
散功率 Power Dissipation	P_D	225	mW
存储温度 storage temperature	Tstg	- 55~150	°C

■ 电特性 ELECTRICAL CHARACTERISTICS

(TA=25°C unless otherwise noted 如无特殊说明, 温度为 25°C)

特性参数 Characteristic	符号 Symbol	测试条件 Test Conditions	最小值 Min.	典型值 Typ.	最大值 Max.	单位 Unit.
反向击穿电压 Reverse Breakdown Voltage	V(BR)	IR = 100μA	70			V
反向漏电流 Reverse Leakage Current	IR	VR = 70V			2.5	μA
		VR = 25V @150°C			30	
		VR = 70V @150°C			50	
正向电压 Forward Voltage	VF	IF = 1.0mA			0.715	V
		IF = 10mA			0.855	
		IF = 50mA			1.0	
		IF = 150mA			1.25	
总容量 Total Capacitance	CT	VR=0,f=1.0MHz			1.5	pF
反向恢复时间 Reverse Recovery Time	t _{rr}	I _F = I _R = 10 mA, I _{RR} = 1.0 mA, R _L = 100Ω			6.0	ns

■ 典型特性 TYPICAL CHARACTERISTICS

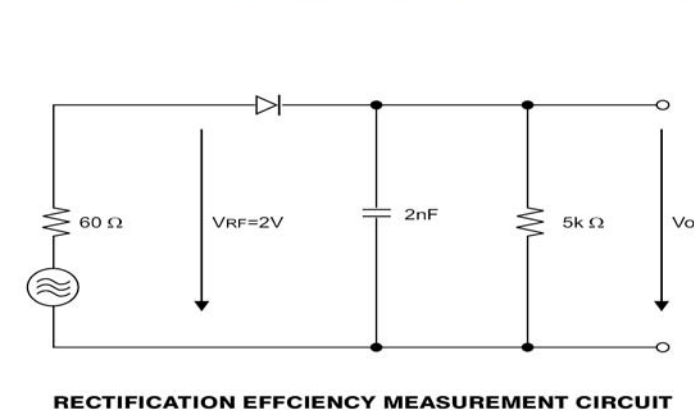
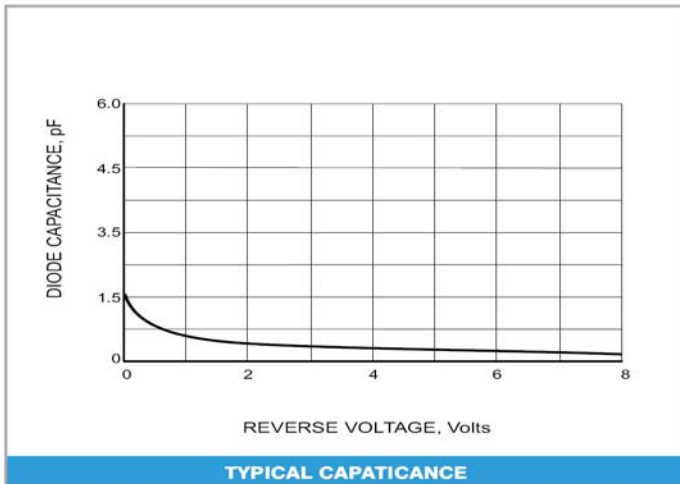
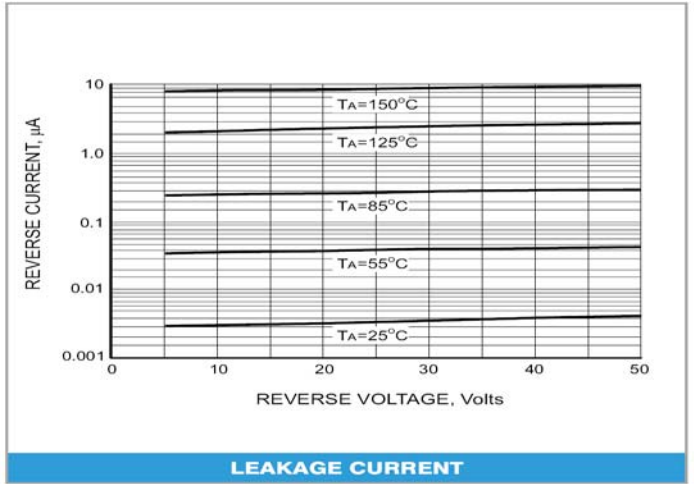
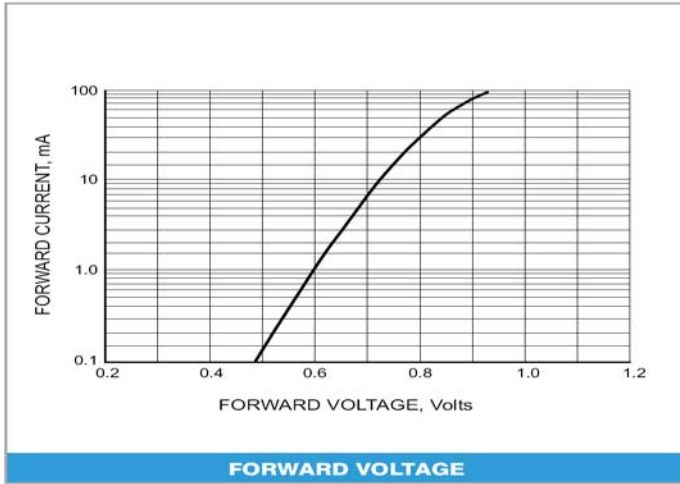

■ 外形尺寸 DIMENSION

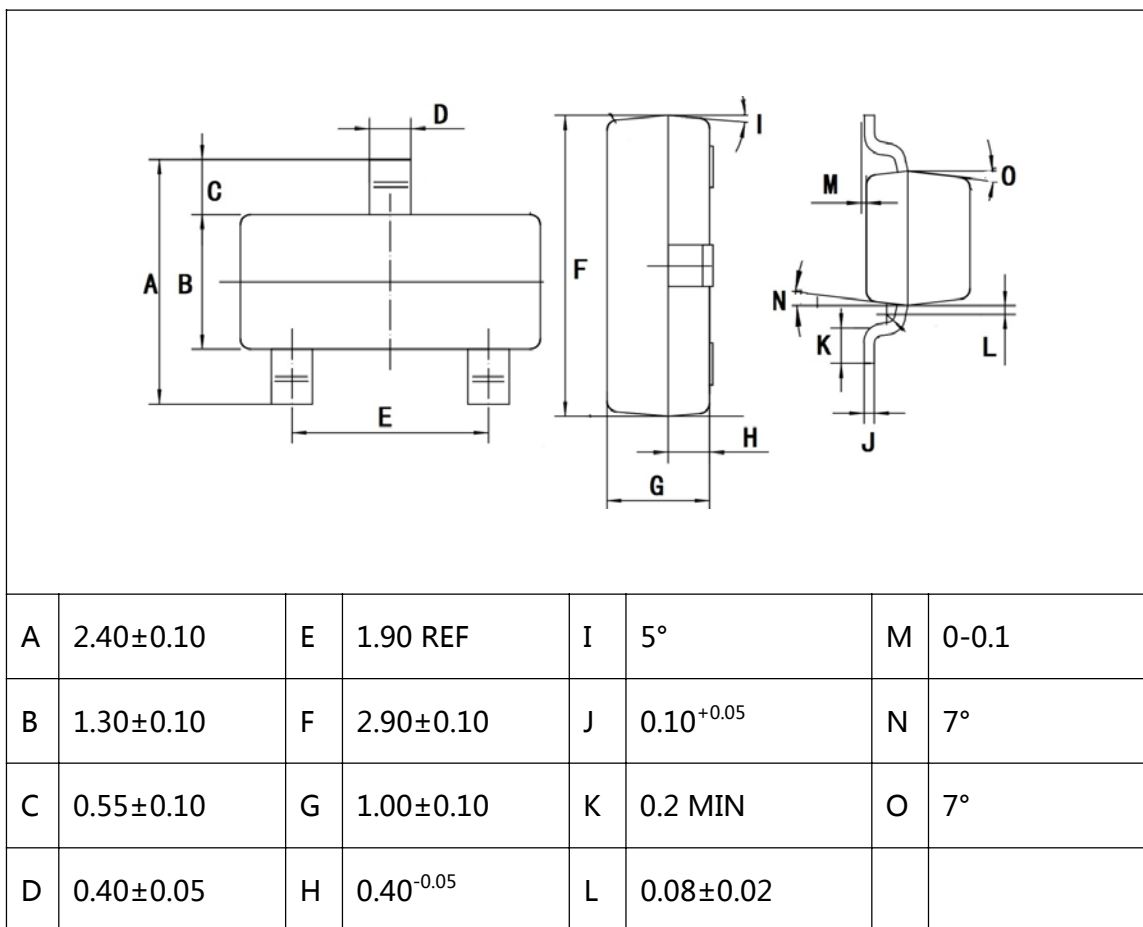

■ 打标 DEVICE MARKING

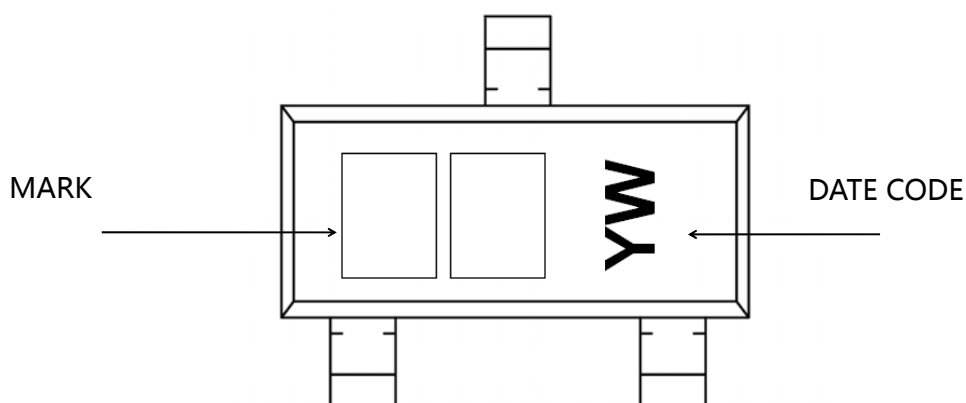

TYPE	FHD99-ME
MARK	A7

■ 包装信息 PACKAGE INFORMATION

材料名称 Material Name	颜色 Color	尺寸 Size	数量 Quantity	备注 Note
卷盘 Reel	蓝色 Blue	7 " *8mm	3K/Reel	
内盒 Inner Case	黄色 Yellow	185*185*140mm	30K/盒 (10 盘/盒) 30K/Case (10 Reel/ Case)	OHO2
外箱 Outer Box	黄色 Yellow	460*400*210mm	180K/箱 (6 盒/箱) 180K/Box (6 Case/Box)	OXO2
标签 Label	白色 White	68*40mm	—	贴卷盘、内盒、外箱 Label on reel、inner case、 outer box

单击下面可查看定价，库存，交付和生命周期等信息

[>>FH\(风华高科\)](#)