



M1F THRU M7F

1.0 AMP SURFACE MOUNT SILICON RECTIFIERS

FEATURES

- * Ideal for surface mount applications
- * Easy pick and place
- * Built-in strain relief
- * High surge current capability

MECHANICAL DATA

- * Case: Molded plastic
- * Epoxy: UL 94V-0 rate flame retardant
- * Terminals: Solder plated, solderable per MIL-STD-202F, method 208 guranteed
- * Polarity: Color band denotes cathode end
- * Mounting position: Any
- *

VOLTAGE RANGE

50 to 1000 Volts

CURRENT

1.0 Ampere

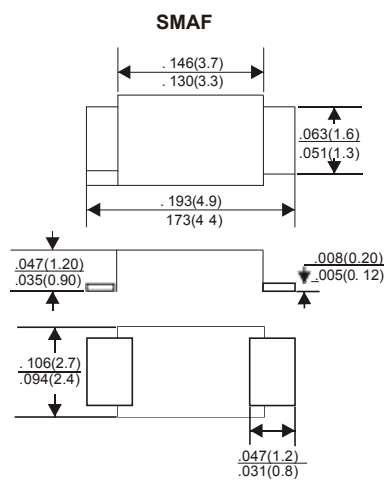

Dimensions in inches and (millimeters)

MAXIMUM RATINGS AND ELECTRICAL CHARACTERISTICS

Rating 25 °C ambient temperature unieess otherwies specified.
Single phase half wave, 60Hz, resistive or inductive load.
For capacitive load, derate current by 20%.

TYPE NUMBER	M1F	M2F	M3F	M4F	M5F	M6F	M7F	UNITS
Maximum Recurrent Peak Reverse Voltage	50	100	200	400	600	800	1000	V
Maximum RMS Voltage	35	70	140	280	420	560	700	V
Maximum DC Blocking Voltage	50	100	200	400	600	800	1000	V
Maximum Average Forward Rectified Current .375"(9.5mm) Lead Length at Ta=75 C	1.0							A
Peak Forward Surge Current, 8.3 ms single half sine-wave superimposed on rated load (JEDEC method)	30							A
Maximum Instantaneous Forward Voltage at 1.0A	1.0							V
Maximum DC Reverse Current Ta=25 C	5.0							μA
at Rated DC Blocking Voltage Ta=100 C	50							μA
Typical Junction Capacitance (Note 1)	9							pF
Typical Thermal Resistance R JA (Note 2)	83							C/W
Operating and Storage Temperature Range T _J , T _{STG}	-55—+150							C

NOTES:

1. Measured at 1MHz and applied reverse voltage of 4.0V D.C.
2. Thermal Resistance from Junction to Ambient.

RATING AND CHARACTERISTIC CURVES (M1F THRU M7F)

FIG.1-TYPICAL FORWARD CHARACTERISTICS

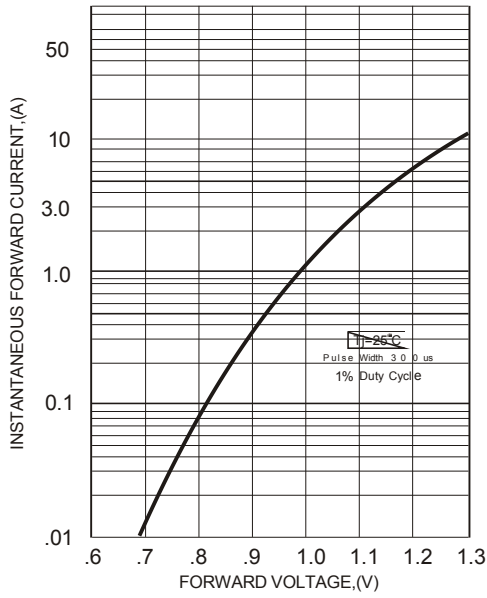

FIG.2-TYPICAL FORWARD CURRENT DERATING CURVE

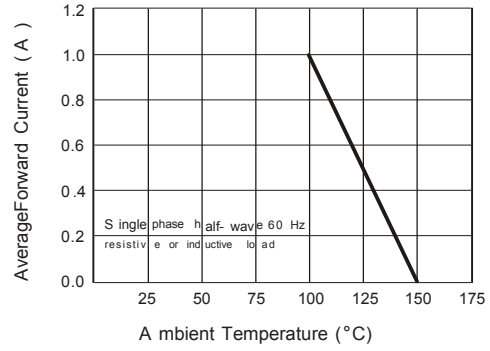

FIG.4-MAXIMUM NON-REPETITIVE FORWARD SURGE CURRENT

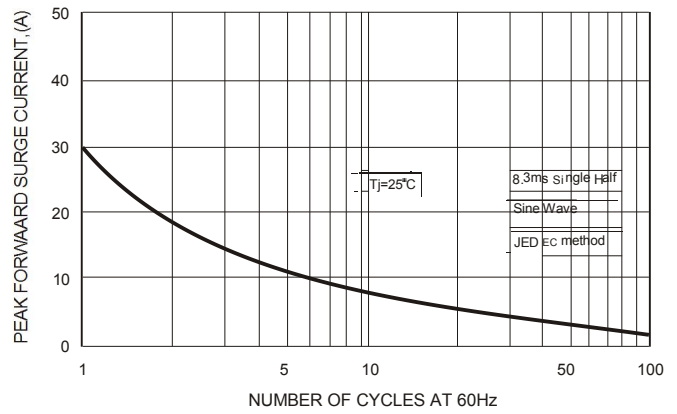

FIG.3 - TYPICAL REVERSE

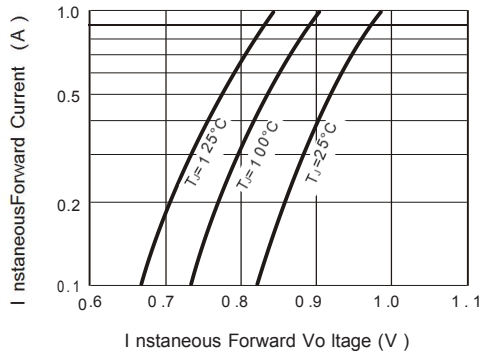
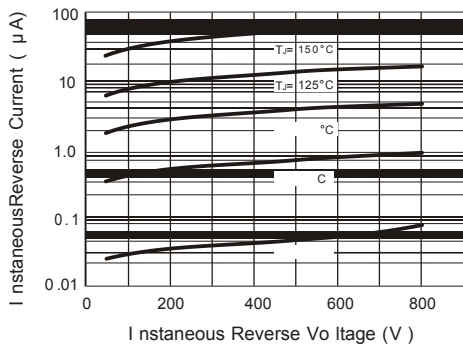
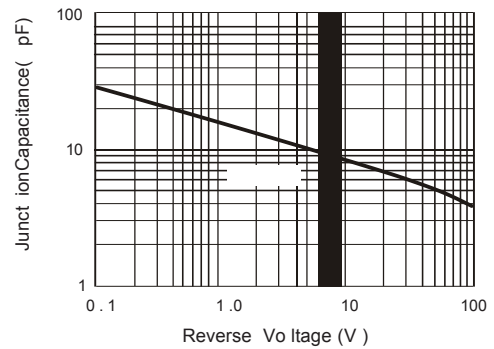

FIG.5-TYPICAL JUNCTION CAPACITANCE



单击下面可查看定价，库存，交付和生命周期等信息

[>>FOSAN\(富信\)](#)