

Features

- Single-Supply Operation from +2.1V ~ +5.5V
- Rail-to-Rail Input / Output
- Gain-Bandwidth Product: 11MHz (Typ.)
- Low Input Bias Current: 1pA (Typ.)
- Low Offset Voltage: 3.5mV (Max.)
- High Slew Rate: 9V/ μ s
- Settling Time to 0.1% with 2V Step: 0.3 μ s
- Low Noise : 8nV/ Hz @10kHz

- Quiescent Current: 1.1mA per Amplifier (Typ.)
- Operating Temperature: -40°C ~ +125°C
- Small Package:

GS8721 Available in SOT23-5, SOP-8 and SC70-5 Packages

GS8722 Available in SOP-8 and MSOP-8 Packages

GS8724 Available in SOP-14 and TSSOP-14 Packages

GS8721N Available in SOT23-6 and SC70-6 Packages

General Description

The GS872X have a high gain-bandwidth product of 11MHz, a slew rate of 9V/ μ s, and a quiescent current of 1.1mA per amplifier at 5V. The GS8721N has a power-down disable feature that reduces the supply current to 90nA. The GS872X are designed to provide optimal performance in low voltage and low noise systems. They provide rail-to-rail output swing into heavy loads. The input common mode voltage range includes ground, and the maximum input offset voltage is 3.5mV for GS872X. They are specified over the extended industrial temperature range (-40°C to +125°C). The operating range is from 2.1V to 5.5V. The GS8721 single is available in Green SC70-5, SOT23-5 and SOP-8 packages. The GS8722 dual is available in Green SOP-8 and MSOP-8 packages. The GS8724 Quad is available in Green SOP-14 and TSSOP-14 packages. The GS8721N single with shutdown is available in Green SOT23-6 and SC70-6 packages.

Applications

- Sensors
- Active Filters
- Cellular and Cordless Phones
- Laptops and PDAs
- Audio
- Handheld Test Equipment
- Battery-Powered Instrumentation
- A/D Converters

Pin Configuration

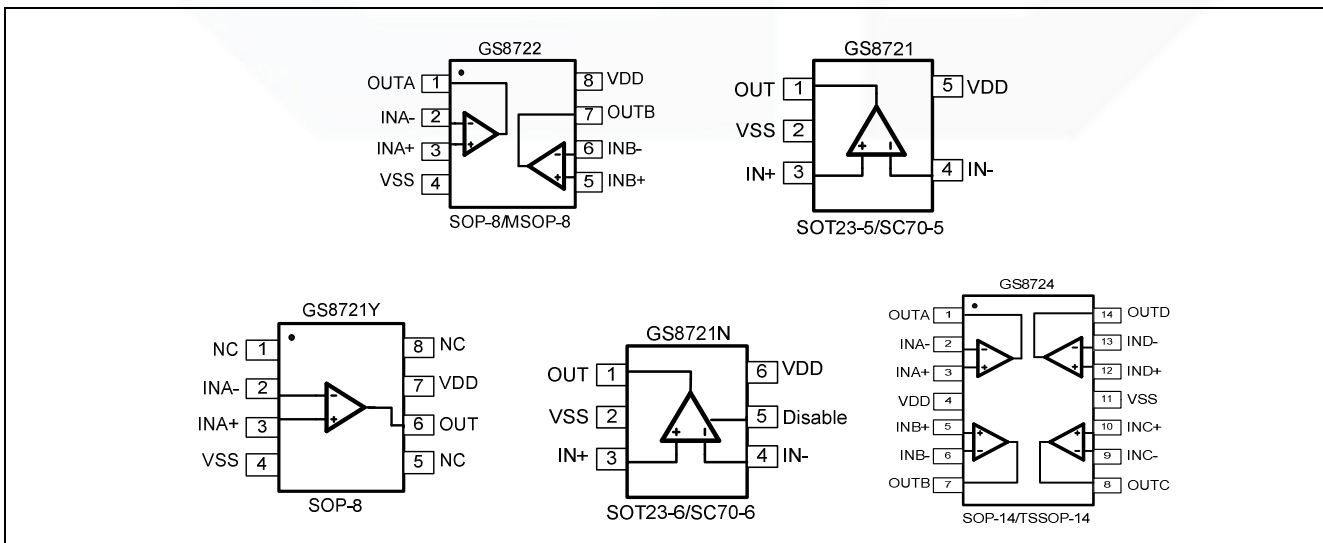

Figure 1. Pin Assignment Diagram

Absolute Maximum Ratings

Condition	Min	Max
Power Supply Voltage (V_{DD} to V_{SS})	-0.5V	+7.5V
Analog Input Voltage (IN+ or IN-)	$V_{SS}-0.5V$	$V_{DD}+0.5V$
PDB Input Voltage	$V_{SS}-0.5V$	+7V
Operating Temperature Range	-40°C	+125°C
Junction Temperature	+160°C	
Storage Temperature Range	-55°C	+150°C
Lead Temperature (soldering, 10sec)	+260°C	
Package Thermal Resistance ($T_A=+25^\circ\text{C}$)		
SOP-8, θ_{JA}	125°C/W	
MSOP-8, θ_{JA}	216°C/W	
SOT23-5, θ_{JA}	190°C/W	
SOT23-6, θ_{JA}	190°C/W	
SC70-5, θ_{JA}	333°C/W	
ESD Susceptibility		
HBM	8KV	
MM	400V	

Note: Stress greater than those listed under Absolute Maximum Ratings may cause permanent damage to the device. This is a stress rating only and functional operation of the device at these or any other conditions outside those indicated in the operational sections of this specification are not implied. Exposure to absolute maximum rating conditions for extended periods may affect reliability.

Package/Ordering Information

MODEL	CHANNEL	ORDER NUMBER	PACKAGE DESCRIPTION	PACKAGE OPTION	MARKING INFORMATION
GS8721	Single	GS8721-CR	SC70-5	Tape and Reel,3000	8721
		GS8721-TR	SOT23-5	Tape and Reel,3000	8721
		GS8721Y-SR	SOP-8	Tape and Reel,2500	GS8721Y
GS8722	Dual	GS8722-SR	SOP-8	Tape and Reel,2500	GS8722
		GS8722-MR	MSOP-8	Tape and Reel,3000	GS8722
GS8724	Quad	GS8724-TR	TSSOP-14	Tape and Reel,3000	GS8724
		GS8724-SR	SOP-14	Tape and Reel,2500	GS8724
GS8721N	Single With shutdown	GS8721N-TR	SOT23-6	Tape and Reel,3000	8721N
		GS8721N-CR	SC70-6	Tape and Reel,3000	8721N

Electrical Characteristics

(At $V_S=5V$, $T_A = +25^\circ C$, $V_{CM} = V_S/2$, $R_L = 600\ \Omega$, unless otherwise noted.)

PARAMETER	CONDITIONS	GS8721/2/4/1N							
		TYP	MIN/MAX OVER TEMPERATURE					UNITS	MIN / MAX
		+25°C	+25°C	0°C to 70°C	-40°C to 85°C	-40°C to 125°C			
INPUT CHARACTERISTICS									
Input Offset Voltage (V_{OS})		0.8	3.5	3.9	4.3	4.6	mV	MAX	
Input Bias Current (I_B)		1					pA	TYP	
Input Offset Current (I_{OS})		1					pA	TYP	
Input Common Mode Voltage Range (V_{CM})	$V_S = 5.5V$	-0.1 to +5.6					V	TYP	
Common Mode Rejection Ratio (CMRR)	$V_S = 5.5V$, $V_{CM} = -0.1V$ to 4V	82	65	64	64	63	dB	MIN	
	$V_S = 5.5V$, $V_{CM} = -0.1V$ to 5.6V	75					dB	MIN	
Open-Loop Voltage Gain (A_{OL})	$R_L = 600\ \Omega$, $V_O = 0.15V$ to 4.85V	90	80	76	75	68	dB	MIN	
	$R_L = 10k\ \Omega$, $V_O = 0.05V$ to 4.95V	108					dB	MIN	
Input Offset Voltage Drift ($\Delta V_{OS}/\Delta T$)		2.4					$\mu V/^\circ C$	TYP	
OUTPUT CHARACTERISTICS									
Output Voltage Swing from Rail	$R_L = 600\ \Omega$	0.1					V	TYP	
	$R_L = 10k\ \Omega$	0.015					V	TYP	
Output Current (I_{OUT})		70	55	45	42	38	mA	MIN	
Closed-Loop Output Impedance	$f = 100kHz$, $G = 1$	7.5					Ω	TYP	
POWER-DOWN DISABLE									
Turn-On Time		1.1					μs	TYP	
Turn-Off Time		0.3					μs	TYP	
DISABLE Voltage-Off			0.8				V	MAX	
DISABLE Voltage-On			2				V	MIN	
POWER SUPPLY									
Operating Voltage Range			2.1	2.1	2.1	2.1	V	MIN	
			5.5	5.5	5.5	5.5	V	MAX	
Power Supply Rejection Ratio (PSRR)	$V_S = +2.5V$ to +5.5V $V_{CM} = (-V_S) + 0.5V$	91	74	72	72	68	dB	MIN	
Quiescent Current/Amplifier (I_Q)	$I_{OUT} = 0$	1.1	1.5	1.65	1.7	1.85	mA	MAX	
Supply Current when Disabled (GS8721N Only)		90					nA	MAX	

Electrical Characteristics

(At $V_S=5V$, $T_A = +25^\circ C$, $V_{CM} = V_S/2$, $R_L = 600\ \Omega$, unless otherwise noted.)

PARAMETER	CONDITIONS	GS8721/2/4/1N							
		TYP	MIN/MAX OVER TEMPERATURE					UNITS	MIN / MAX
		+25°C	+25°C	0°C to 70°C	-40°C to 85°C	-40°C to 125°C			
DYNAMIC PERFORMANCE									
Gain-Bandwidth Product (GBP)	$R_L = 10k\Omega$, $C_L = 100pF$	11						MHz	TYP
Phase Margin (ϕ_o)	$R_L = 10k\Omega$, $C_L = 100pF$	51						Degrees	TYP
Full Power Bandwidth (BWP)	< 1% distortion, $R_L = 600\Omega$	400						kHz	TYP
Slew Rate (SR)	$G = +1$, 2V Step, $R_L = 10k\Omega$	9						V/ μs	TYP
Settling Time to 0.1% (t_s)	$G = +1$, 2V Step, $R_L = 600\Omega$	0.3						μs	TYP
Overload Recovery Time	$V_{IN} \cdot Gain = V_S$, $R_L = 600\Omega$	1.5						μs	TYP
NOISE PERFORMANCE									
Voltage Noise Density (e_n)	$f = 1kHz$	11.5						nV/\sqrt{Hz}	TYP
	$f = 10kHz$	8						nV/\sqrt{Hz}	TYP

Typical Performance characteristics

(At $V_s=5V$, $T_A = +25^\circ C$, $V_{CM} = V_s/2$, $R_L = 600\Omega$, unless otherwise noted.)

Large-Signal Step Response

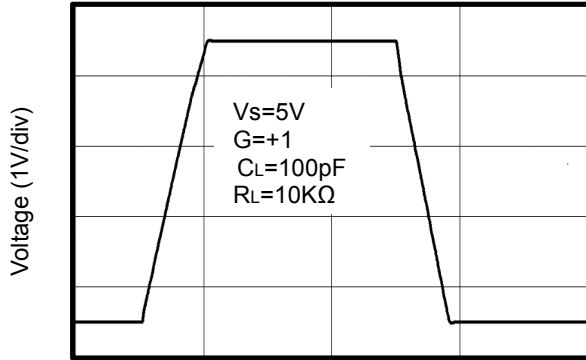

Time (1µs/div)

Large-Signal Step Response

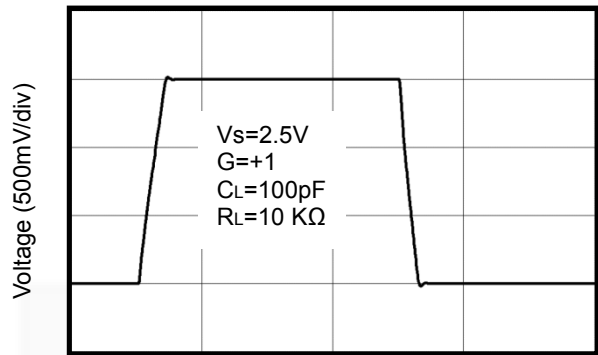

Time (1µs/div)

Small-Signal Step Response

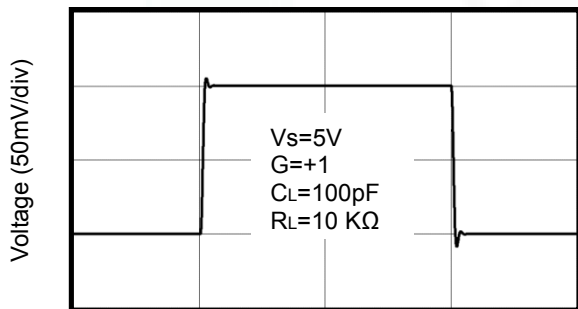

Time (1µs/div)

Small-Signal Step Response

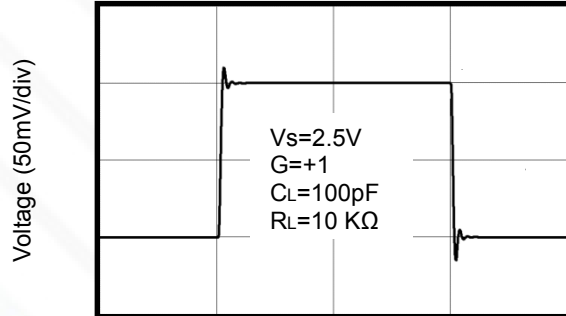

Time (1µs/div)

Positive Overload Recovery

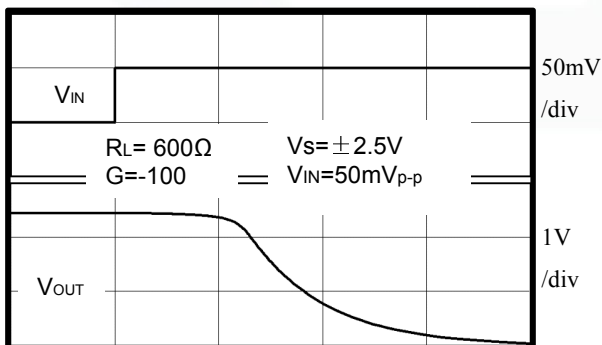

Time (2µs/div)

Negative Overload Recovery

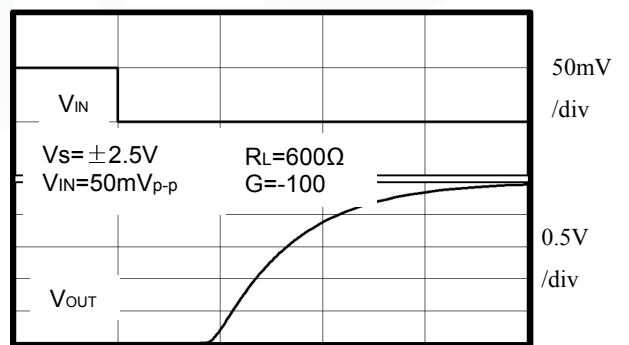

Time (2µs/div)

Typical Performance characteristics

(At $V_s=5V$, $T_A = +25^\circ C$, $V_{CM} = V_s/2$, $R_L = 600\Omega$, unless otherwise noted.)

Output Voltage Swing vs. Output Current

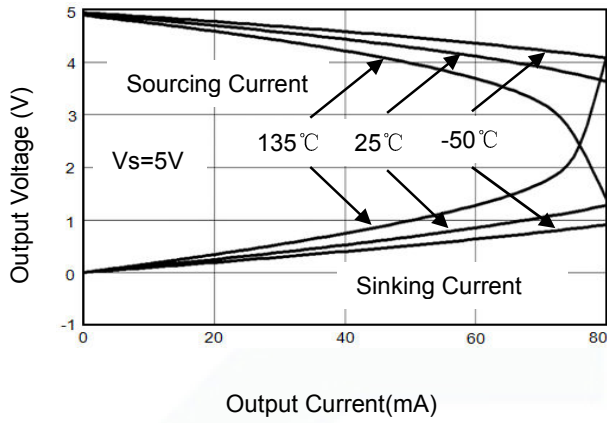

Supply Current vs. Temperature

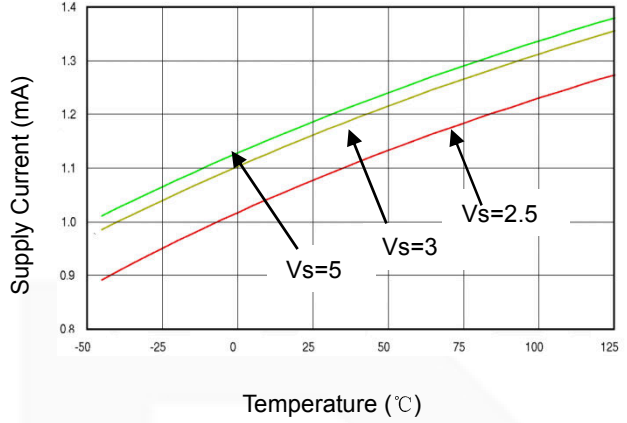

Input Voltage Noise Spectral Density vs. Frequency

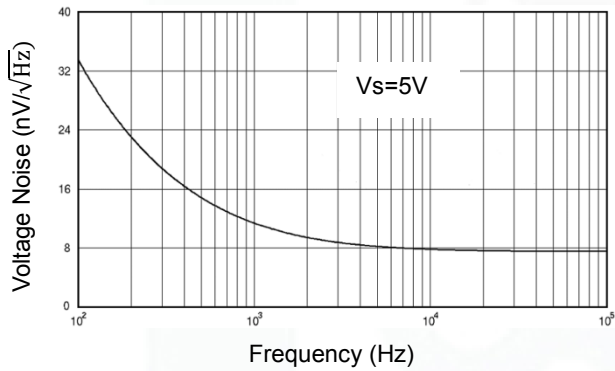

Open Loop Gain, Phase Shift vs. Frequency

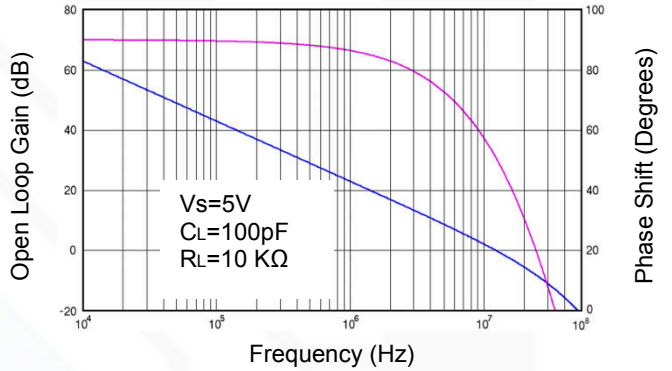

CMRR vs. Frequency

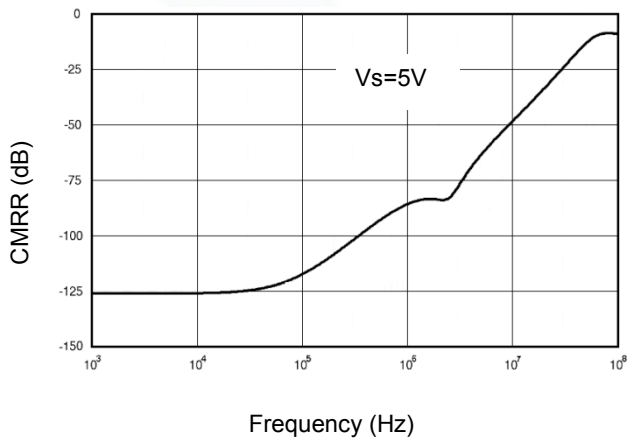

PSRR vs. Frequency

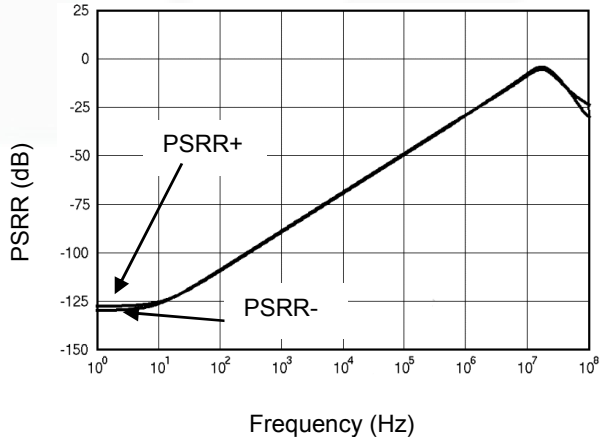

Application Note

Size

GS872X series op amps are unity-gain stable and suitable for a wide range of general-purpose applications. The small footprints of the GS872X series packages save space on printed circuit boards and enable the design of smaller electronic products.

Power Supply Bypassing and Board Layout

GS872X series operates from a single 2.1V to 5.5V supply or dual $\pm 1.05\text{V}$ to $\pm 2.75\text{V}$ supplies. For best performance, a $0.1\mu\text{F}$ ceramic capacitor should be placed close to the V_{DD} pin in single supply operation. For dual supply operation, both V_{DD} and V_{SS} supplies should be bypassed to ground with separate $0.1\mu\text{F}$ ceramic capacitors.

Low Supply Current

The low supply current (typical 1.1mA per channel) of GS872X series will help to maximize battery life. They are ideal for battery powered systems

Operating Voltage

GS872X series operate under wide input supply voltage (2.1V to 5.5V). In addition, all temperature specifications apply from -40°C to $+125^\circ\text{C}$. Most behavior remains unchanged throughout the full operating voltage range. These guarantees ensure operation throughout the single Li-Ion battery lifetime

Rail-to-Rail Input

The input common-mode range of GS872X series extends 100mV beyond the supply rails ($V_{\text{SS}}-0.1\text{V}$ to $V_{\text{DD}}+0.1\text{V}$). This is achieved by using complementary input stage. For normal operation, inputs should be limited to this range.

Rail-to-Rail Output

Rail-to-Rail output swing provides maximum possible dynamic range at the output. This is particularly important when operating in low supply voltages. The output voltage of GS872X series can typically swing to less than 2mV from supply rail in light resistive loads ($>100\text{k}\Omega$), and 15mV of supply rail in moderate resistive loads ($10\text{k}\Omega$).

Capacitive Load Tolerance

The GS872X family is optimized for bandwidth and speed, not for driving capacitive loads. Output capacitance will create a pole in the amplifier's feedback path, leading to excessive peaking and potential oscillation. If dealing with load capacitance is a requirement of the application, the two strategies to consider are (1) using a small resistor in series with the amplifier's output and the load capacitance and (2) reducing the bandwidth of the amplifier's feedback loop by increasing the overall noise gain. Figure 2. shows a unity gain follower using the series resistor strategy. The resistor isolates the output from the capacitance and, more importantly, creates a zero in the feedback path that compensates for the pole created by the output capacitance.

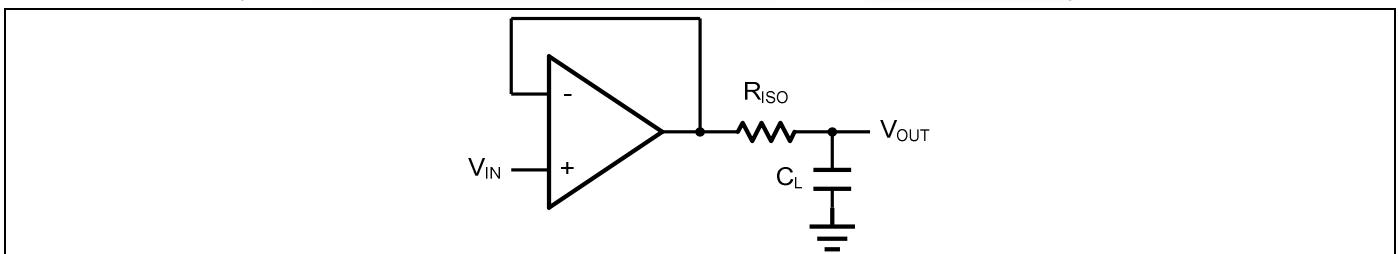

Figure 2. Indirectly Driving a Capacitive Load Using Isolation Resistor

The bigger the R_{ISO} resistor value, the more stable V_{OUT} will be. However, if there is a resistive load R_{L} in parallel with the capacitive load, a voltage divider (proportional to $R_{\text{ISO}}/R_{\text{L}}$) is formed, this will result in a gain error.

The circuit in Figure 3 is an improvement to the one in Figure 2. R_{F} provides the DC accuracy by feed-forward the V_{IN} to R_{L} . C_{F}

and R_{ISO} serve to counteract the loss of phase margin by feeding the high frequency component of the output signal back to the amplifier's inverting input, thereby preserving the phase margin in the overall feedback loop. Capacitive drive can be increased by increasing the value of C_F . This in turn will slow down the pulse response.

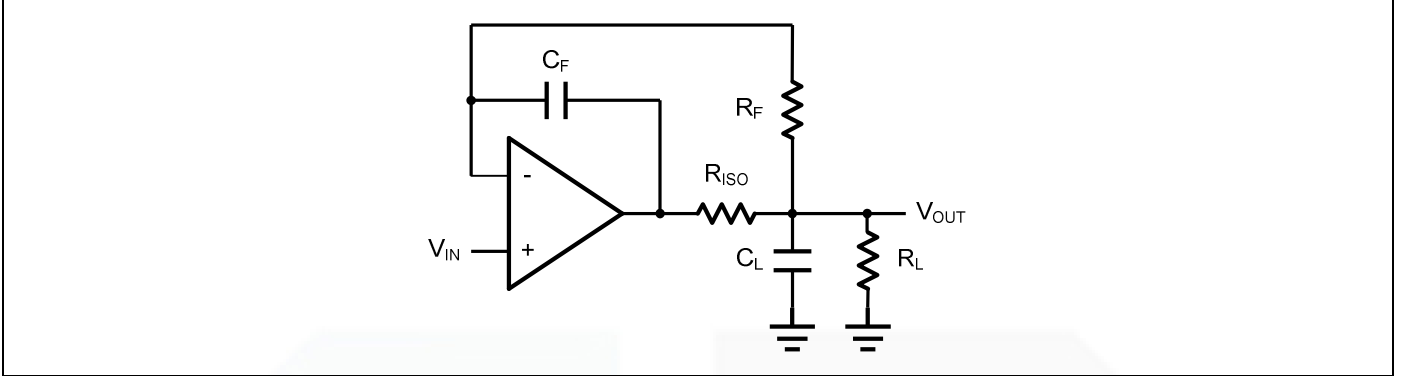

Figure 3. Indirectly Driving a Capacitive Load with DC Accuracy

Typical Application Circuits

Differential amplifier

The differential amplifier allows the subtraction of two input voltages or cancellation of a signal common to the two inputs. It is useful as a computational amplifier in making a differential to single-end conversion or in rejecting a common mode signal. Figure 4. shows the differential amplifier using GS872X.

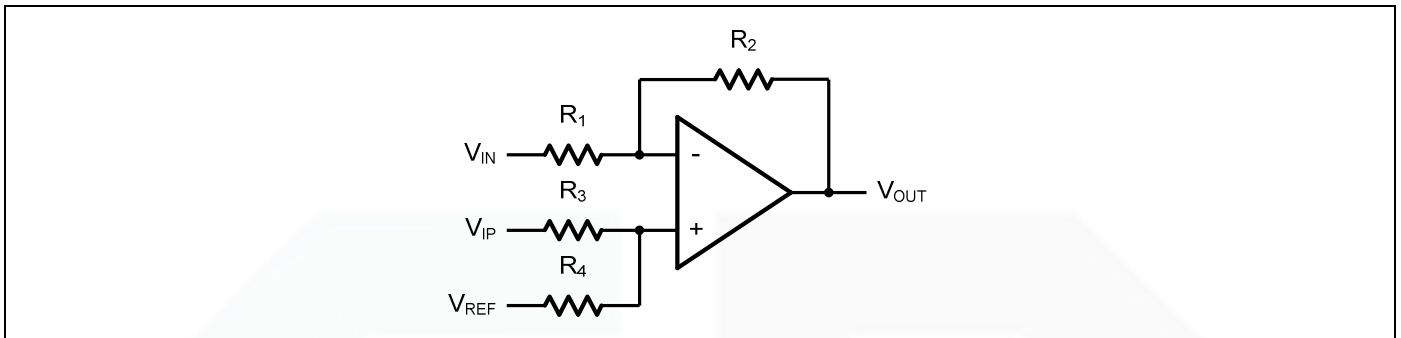

Figure 4. Differential Amplifier

$$V_{OUT} = \left(\frac{R_1 + R_2}{R_3 + R_4} \right) \frac{R_4}{R_1} V_{IN} - \frac{R_2}{R_1} V_{IP} + \left(\frac{R_1 + R_2}{R_3 + R_4} \right) \frac{R_3}{R_1} V_{REF}$$

If the resistor ratios are equal (i.e. $R_1 = R_3$ and $R_2 = R_4$), then

$$V_{OUT} = \frac{R_2}{R_1} (V_{IP} - V_{IN}) + V_{REF}$$

Low Pass Active Filter

The low pass active filter is shown in Figure 5. The DC gain is defined by $-R_2/R_1$. The filter has a -20dB/decade roll-off after its corner frequency $f_c = 1/(2\pi R_3 C_1)$.

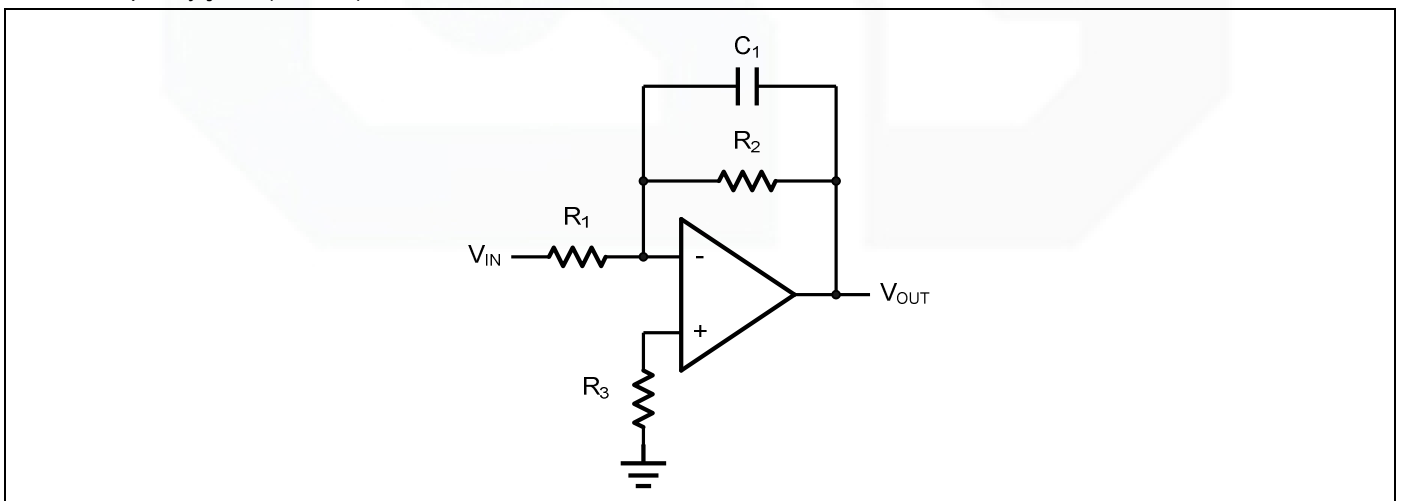

Figure 5. Low Pass Active Filter

Instrumentation Amplifier

The triple GS872X can be used to build a three-op-amp instrumentation amplifier as shown in Figure 6. The amplifier in Figure 6 is a high input impedance differential amplifier with gain of R_2/R_1 . The two differential voltage followers assure the high input impedance of the amplifier.

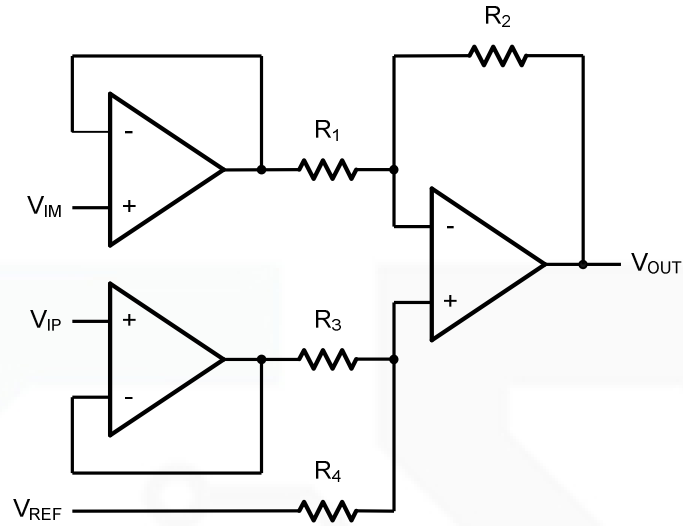
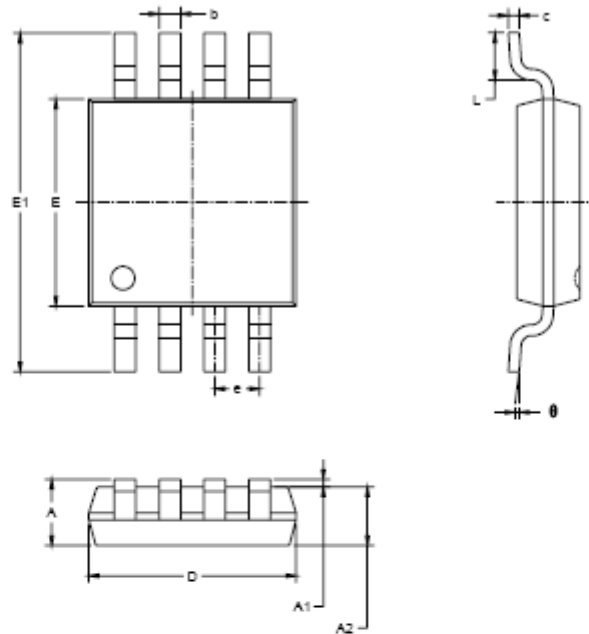
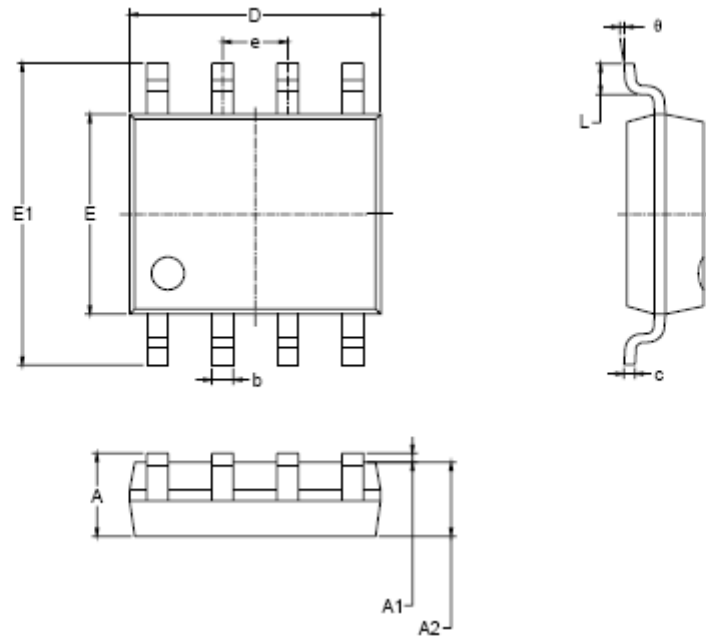

Figure 6. Instrument Amplifier

Package Information
MSOP-8

Symbol	Dimensions In Millimeters		Dimensions In Inches	
	MIN	MAX	MIN	MAX
A	0.820	1.100	0.032	0.043
A1	0.020	0.150	0.001	0.008
A2	0.750	0.950	0.030	0.037
b	0.250	0.380	0.010	0.015
c	0.090	0.230	0.004	0.009
D	2.900	3.100	0.114	0.122
E	2.900	3.100	0.114	0.122
E1	4.750	5.050	0.187	0.199
e	0.650 BSC		0.026 BSC	
L	0.400	0.800	0.016	0.031
θ	0°	8°	0°	8°

SOP-8

Symbol	Dimensions In Millimeters		Dimensions In Inches	
	MIN	MAX	MIN	MAX
A	1.350	1.750	0.053	0.069
A1	0.100	0.250	0.004	0.010
A2	1.350	1.550	0.053	0.061
b	0.330	0.510	0.013	0.020
c	0.170	0.250	0.006	0.010
D	4.700	5.100	0.185	0.200
E	3.800	4.000	0.150	0.157
E1	5.800	6.200	0.228	0.244
e	1.27 BSC		0.050 BSC	
L	0.400	1.270	0.016	0.050
θ	0°	8°	0°	8°

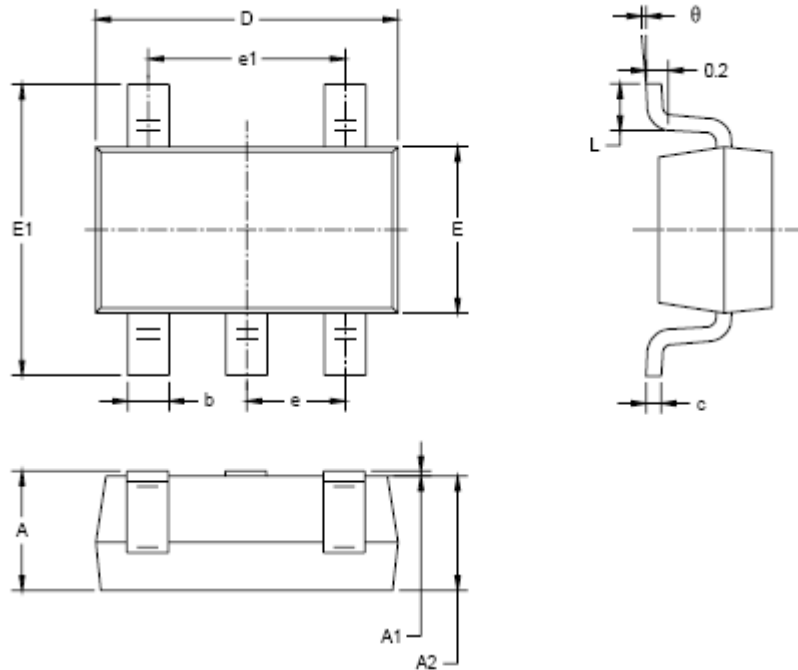
SOT23-5

Symbol	Dimensions In Millimeters		Dimensions In Inches	
	MIN	MAX	MIN	MAX
A	1.050	1.250	0.041	0.049
A1	0.000	0.100	0.000	0.004
A2	1.050	1.150	0.041	0.045
b	0.300	0.500	0.012	0.020
c	0.100	0.200	0.004	0.008
D	2.820	3.020	0.111	0.119
E	1.500	1.700	0.059	0.067
E1	2.650	2.950	0.104	0.118
e	0.950 BSC		0.037 BSC	
e1	1.900 BSC		0.075 BSC	
L	0.300	0.600	0.012	0.024
θ	0°	8°	0°	8°

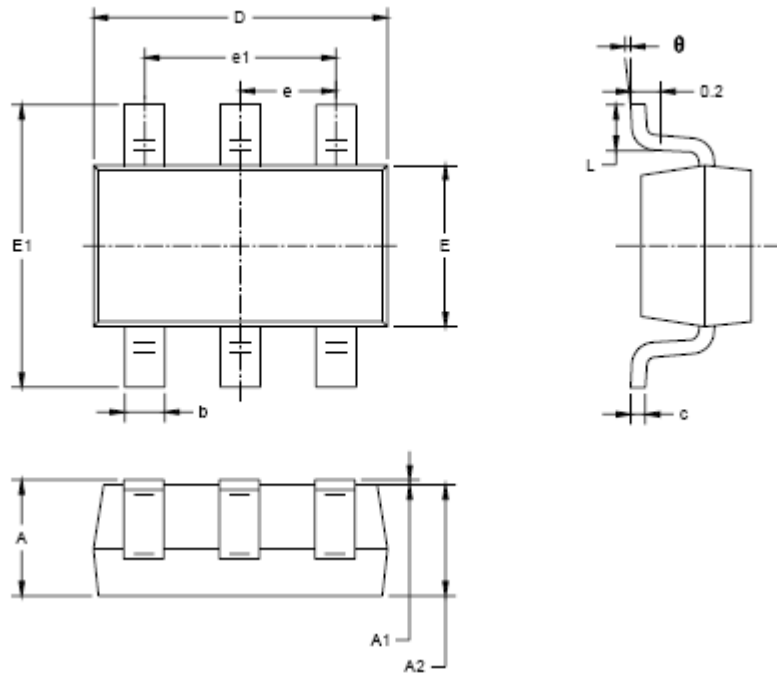
SOT23-6

Symbol	Dimensions In Millimeters		Dimensions In Inches	
	MIN	MAX	MIN	MAX
A	1.050	1.250	0.041	0.049
A1	0.000	0.100	0.000	0.004
A2	1.050	1.150	0.041	0.045
b	0.300	0.500	0.012	0.020
c	0.100	0.200	0.004	0.008
D	2.820	3.020	0.111	0.119
E	1.500	1.700	0.059	0.067
E1	2.650	2.950	0.104	0.116
e	0.950 BSC		0.037 BSC	
e1	1.900 BSC		0.075 BSC	
L	0.300	0.600	0.012	0.024
θ	0°	8°	0°	8°

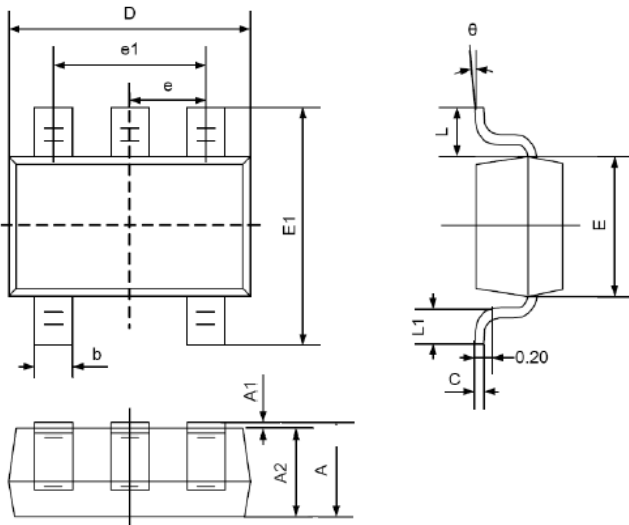
SC70-5

Symbol	Dimensions In Millimeters		Dimensions In Inches	
	Min	Max	Min	Max
A	0.900	1.100	0.035	0.043
A1	0.000	0.100	0.000	0.004
A2	0.900	1.000	0.035	0.039
b	0.150	0.350	0.006	0.014
C	0.080	0.150	0.003	0.006
D	2.000	2.200	0.079	0.087
E	1.150	1.350	0.045	0.053
E1	2.150	2.450	0.085	0.096
e	0.650TYP		0.026TYP	
e1	1.200	1.400	0.047	0.055
L	0.525REF		0.021REF	
L1	0.260	0.460	0.010	0.018
θ	0°	8°	0°	8°

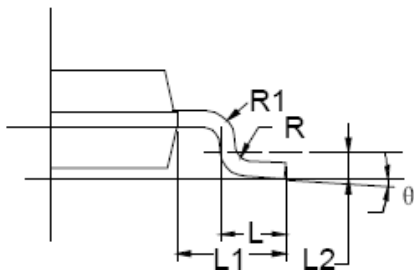
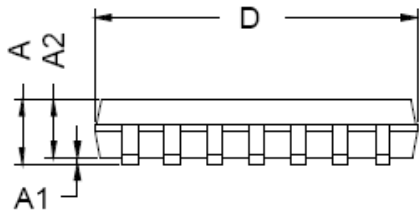
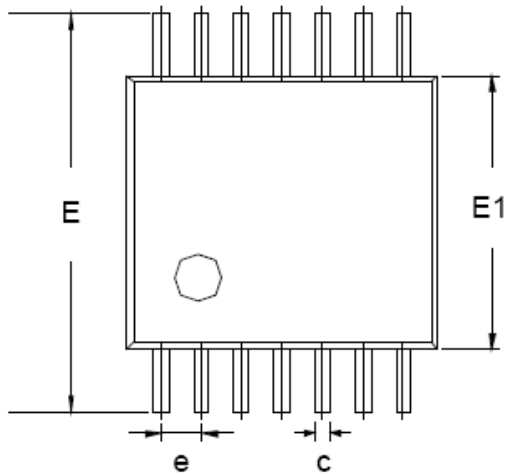
TSSOP-14

Symbol	Dimensions In Millimeters		
	MIN	TYP	MAX
A	-	-	1.20
A1	0.05	-	0.15
A2	0.90	1.00	1.05
b	0.20	-	0.28
c	0.10	-	0.19
D	4.86	4.96	5.06
E	6.20	6.40	6.60
E1	4.30	4.40	4.50
e	0.65 BSC		
L	0.45	0.60	0.75
L1	1.00 REF		
L2	0.25 BSC		
R	0.09	-	-
θ	0°	-	8°

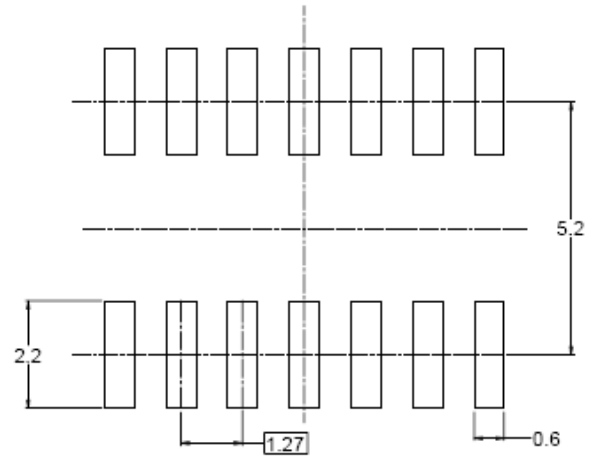
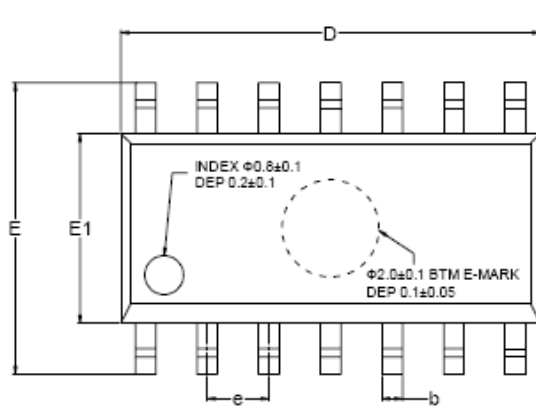
SOP-14

RECOMMENDED LAND PATTERN (Unit: mm)

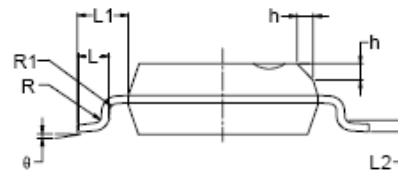
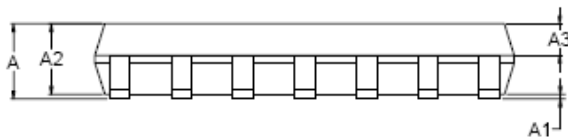

Symbol	Dimensions In Millimeters			Dimensions In Inches		
	MIN	MOD	MAX	MIN	MOD	MAX
A	1.35		1.75	0.053		0.069
A1	0.10		0.25	0.004		0.010
A2	1.25		1.65	0.049		0.065
A3	0.55		0.75	0.022		0.030
b	0.36		0.49	0.014		0.019
D	8.53		8.73	0.336		0.344
E	5.80		6.20	0.228		0.244
E1	3.80		4.00	0.150		0.157
e	1.27 BSC			0.050 BSC		
L	0.45		0.80	0.018		0.032
L1	1.04 REF			0.040 REF		
L2	0.25 BSC			0.01 BSC		
R	0.07			0.003		
R1	0.07			0.003		
h	0.30		0.50	0.012		0.020
θ	0°		8°	0°		8°

单击下面可查看定价，库存，交付和生命周期等信息

[>>Gainsil\(聚洵\)](#)