

DESCRIPTION

The GLF71310 is an ultra-efficiency, 2 A rated, Load Switch with integrated slew rate control. The best in class efficiency makes it an ideal choice for use in IoT, mobile, and wearable electronics.

The GLF71310 features ultra-efficient I_QSmart™ technology that supports the lowest quiescent current (I_Q) and shutdown current (I_{SD}) in the industry. Low I_Q and I_{SD} solutions help designers to reduce parasitic leakage current, improve system efficiency, and increase battery lifetime.

The GLF71310 integrated slew rate control can also enhance system reliability by mitigating bus voltage swings during switching events. Where uncontrolled switches can generate high inrush currents that result in voltage droop and/or bus reset events, the GLF slew rate control specifically limits inrush currents during turn-on to minimize voltage droop.

GLF71310 Load Switch devices support an industry leading wide input voltage range and helps to improve operating life and system robustness. Furthermore, one device can be used in multiple voltage rail applications which helps to simplify inventory management and reduce operating cost.

GLF71310 Load Switch device is small utilizing a chip scale package with 4 bumps in a 0.97 mm x 0.97 mm x 0.55 mm die size and a 0.5 mm bump pitch.

FEATURES

- Ultra-Low I_Q: 7 nA Typ @ 5.5 V_{IN}
- Ultra-Low I_{SD}: 28 nA Typ @ 5.5 V_{IN}
- Low R_{ON} : 31 mΩ Typ @ 5.5 V_{IN}
- I_{OUT} Max: 2 A
- Wide Input Range: 1.1 V to 5.5 V
6 Vabs max
- Controlled Rise Time: 335 us at 3.3 V_{IN}
- Internal EN Pull-Down Resistor
- Ultra-Small: 0.97 mm x 0.97 mm

APPLICATIONS

- Wearables
- Data Storage, SSD
- Mobile Devices
- Low Power Subsystems

PACKAGE

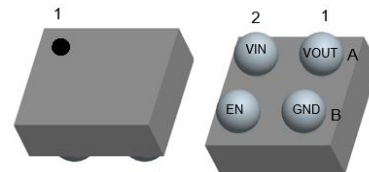

0.97 mm x 0.97 mm x 0.55 mm WLCSP

PACKAGE OUTLINE

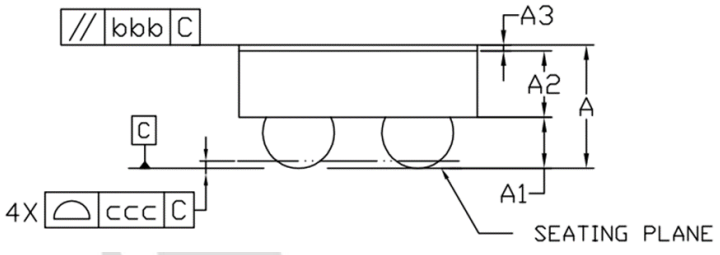
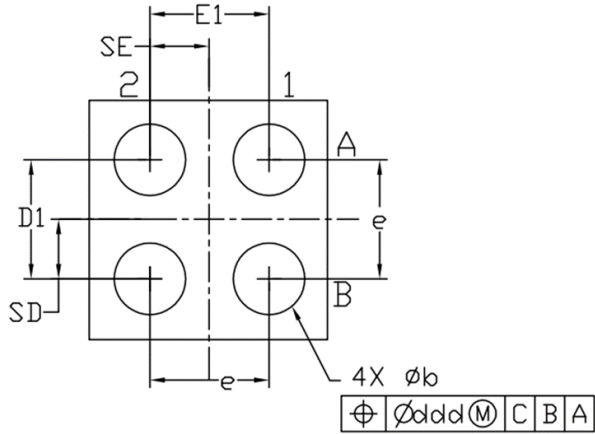
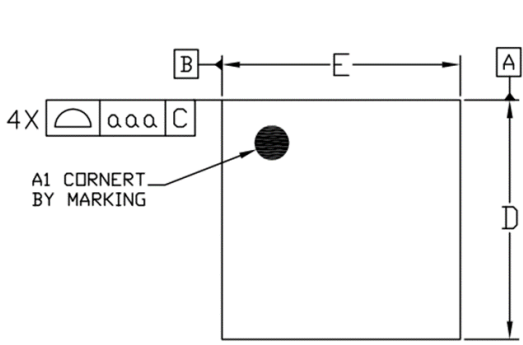

Dimensional Ref.			
REF.	Min.	Nom.	Max.
A	0.500	0.550	0.600
A1	0.225	0.250	0.275
A2	0.255	0.275	0.300
A3	0.020	0.025	0.030
D	0.960	0.970	0.985
E	0.960	0.970	0.985
D1	0.450	0.500	0.550
E1	0.450	0.500	0.550
b	0.260	0.310	0.360
e	0.500 BSC		
SD	0.250 BSC		
SE	0.250 BSC		
Tol. of Form&Position			
aaa	0.10		
bbb	0.10		
ccc	0.05		
ddd	0.05		

Notes

1. ALL DIMENSIONS ARE IN MILLIMETERS (ANGLES IN DEGREES)
2. DIMENSIONING AND TOLERANCING PER ANSI Y14.5M-1994.
3. A3: BACKSIDE LAMINATION

TAPE AND REEL INFORMATION

REEL DIMENSIONS

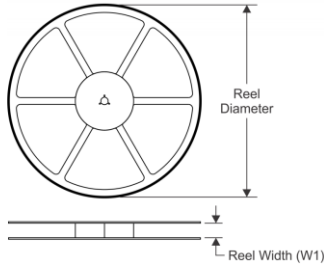

QUADRANT ASSIGNMENTS PIN 1 ORIENTATION TAPE

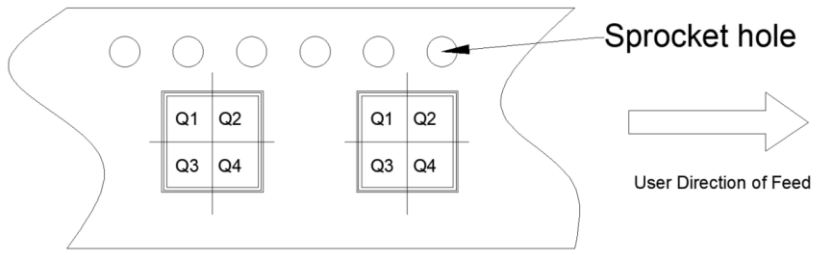

TAPE DIMENSIONS

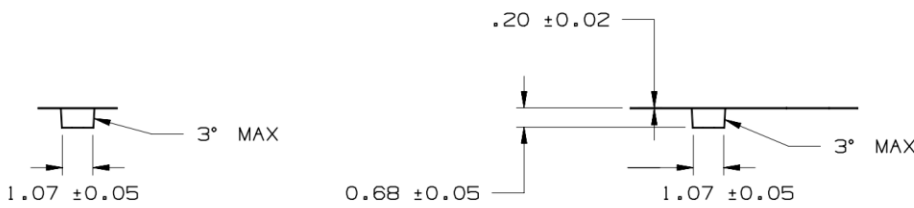
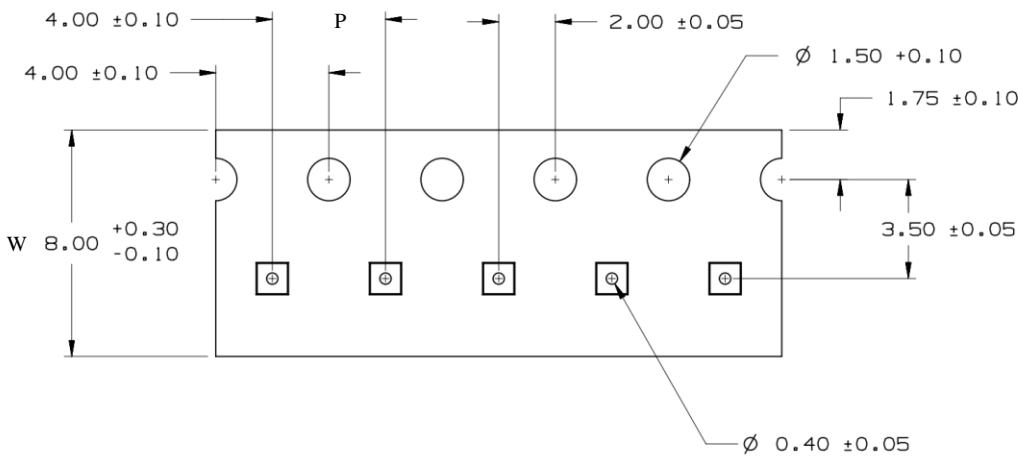

Device	Package	Pins	SPQ	Reel Diameter(mm)	Reel Width W1	A0	B0	K0	P	W	Pin1
GLF71310	WLCSP	4	3000	180	9	1.07	1.07	0.68	4	8	Q1
GLF71310	WLCSP	4	3000	180	9	1.07	1.07	0.68	4	8	Q1
GLF71312	WLCSP	4	3000	180	9	1.07	1.07	0.68	4	8	Q1
GLF71313	WLCSP	4	3000	180	9	1.07	1.07	0.68	4	8	Q1

Remark:

- A0: Dimension designed to accommodate the component width
- B0: Dimension designed to accommodate the component length
- C0: Dimension designed to accommodate the component thickness
- W: Overall width of the carrier tape
- P: Pitch between successive cavity centers

单击下面可查看定价，库存，交付和生命周期等信息

[>>GLF\(杰夫微\)](#)