

DESCRIPTION

The GLF76521 is an ultra-thin, ultra-efficient I_QSmart™ load switch with an integrated deep sleep timer for wearables and IoT devices.

The /SRO pin activates ultra-deep sleep mode, conserving power by isolating the system from the battery with ultra-low standby current of 7 nA typical. The load switch, placed between the battery and the system, can help significantly extend system battery life in mobile devices during shipping or periods of extended off time.

The part supports two methods for entering deep sleep mode: through user input or interrupt initiated events. Deep sleep can be enabled or exited by holding the /SRO pin low for a predefined delay time (ideal for user control) or by providing a rising edge signal to the OFF pin (ideal for logic or interrupt control).

To exit deep sleep, the user can hold down the /SRO pin to ground for 0.3 seconds, or simply connect a charger adapter to trigger the Wake pin.

The GLF76521 helps to reduce power consumption with the best in class R_{ON} and a breakthrough on state I_Q of only 3 nA typical when the switch is on.

The GLF76521 integrated 1 ms slew rate control can also enhance system reliability by mitigating bus voltage swings during switching events. Uncontrolled switching can generate high inrush currents that result in voltage droop and / or bus reset events. The GLF slew rate control specifically limits inrush currents during turn-on to minimize voltage droop. The output discharge functions ensures the output voltage will drop off quickly when the switch is disabled.

The GLF76521 is available in 0.97mm x 1.47mm x 0.55mm wafer level chip scale package (WLCSP).

FEATURES

- Ultra-Low I_{SD}: 7 nA Typ @ 3.6VBAT
- Ultra-Low I_Q: 3 nA Typ @ 3.6VBAT
- Low R_{ON} : 31 mΩ Typ @ 3.6VBAT
- I_{OUT} Max : 2 A
- Wide Input Range: 1.8 V to 5.5 V
6 V abs max
- Deep Sleep Mode by /SRO and OFF pins to disconnect the downstream system from the battery source
- Integrated Delay Time(Hold Time) to Deep Sleep, 1.8 s
- Turn-Off Delay Time, 1.8 s
- Controlled Output Rise Time: 1 ms at 3.6VBAT
- Integrated Output Discharge Switch When Disabled
- Operating Temperature Range: -40 to 85 °C
- HBM: 6 kV, CDM: 2 kV
- Ultra-Small: 0.97 mm x 1.47 mm WLCSP

APPLICATIONS

- Wearables / Smart Cards
- IoT Devices
- Medical Devices

PACKAGE

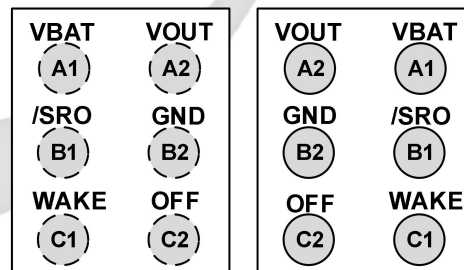

TOP VIEW

BOTTOM VIEW

0.97 mm x 1.47 mm x 0.55 mm WLCSP

PACKAGE OUTLINE

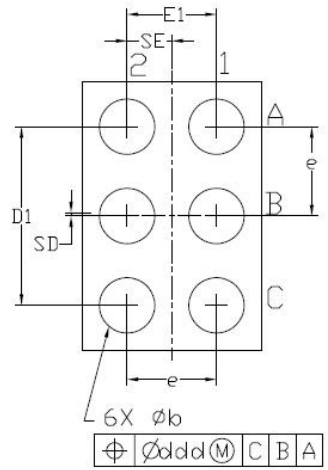
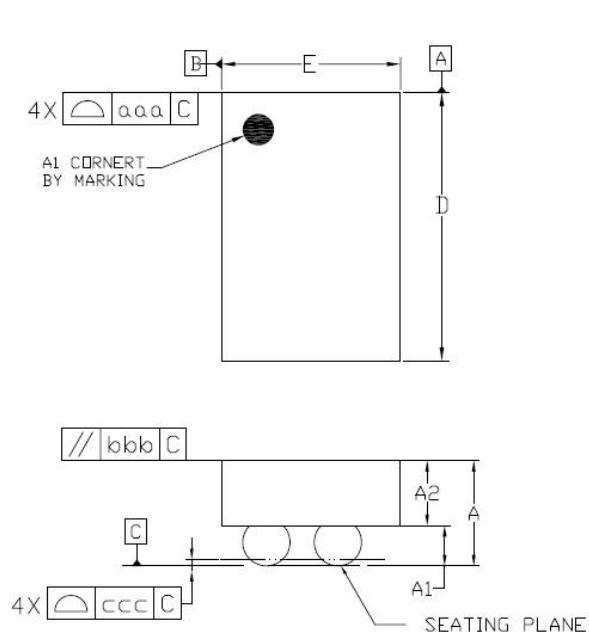

Dimensional Ref.			
REF.	Min.	Nom.	Max.
A	0.500	0.550	0.600
A1	0.225	0.250	0.275
A2	0.275	0.300	0.325
D	1.460	1.470	1.485
D1	0.950	1.000	1.050
E1	0.450	0.500	0.550
b	0.260	0.310	0.360
e	0.500 BSC		
SD	0.000 BSC		
SE	0.250 BSC		
Tol. of Form&Position			
aaa	0.10		
bbb	0.10		
ccc	0.05		
ddd	0.05		

Notes

1. ALL DIMENSIONS ARE IN MILLIMETERS (ANGLES IN DEGREES).
2. DIMENSIONING AND TOLERANCING PER ANSI Y14.5M-1994.



TAPE AND REEL INFORMATION

REEL DIMENSIONS

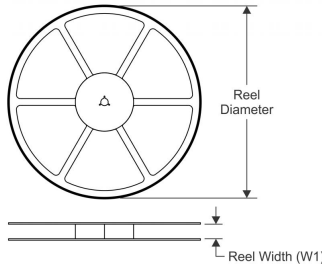

QUADRANT ASSIGNMENTS PIN 1 ORIENTATION TAPE

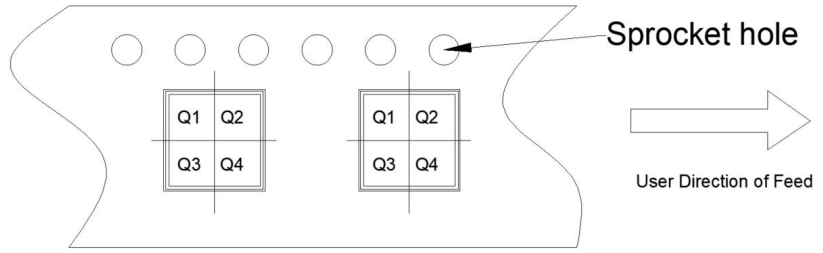

TAPE DIMENSIONS

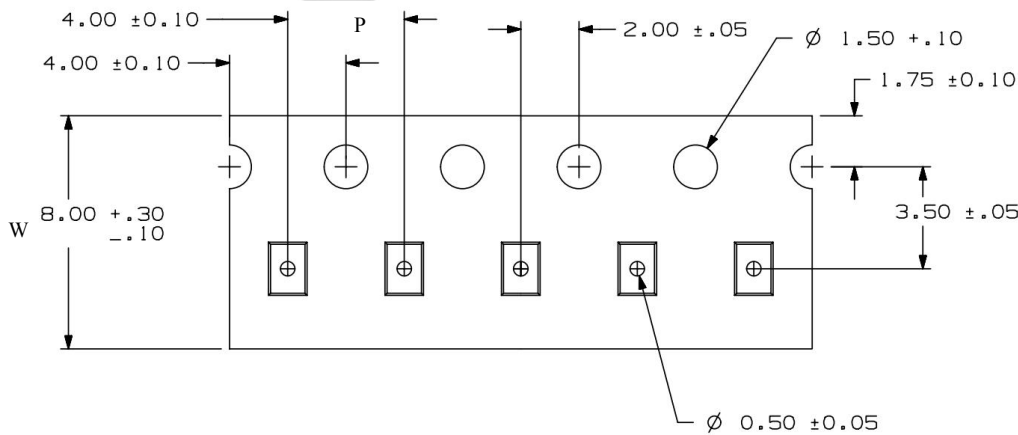

POWER

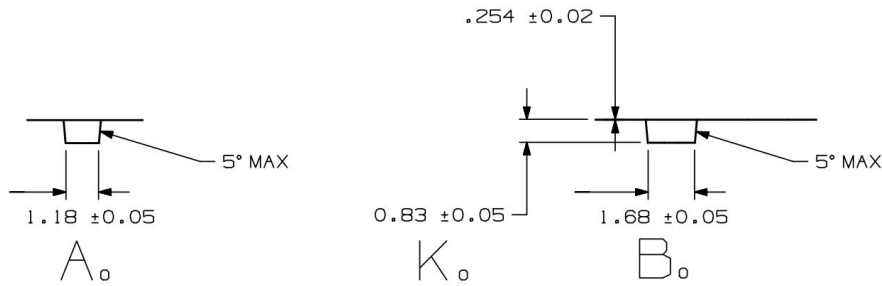

Device	Package	Pins	SPQ	Reel Diameter(mm)	Reel Width W1	A0	B0	K0	P	W	Pin1
GLF76521	WLCSP	6	3000	180	9	1.18	1.68	0.83	4	8	Q1

Remark:

- A0: Dimension designed to accommodate the component width
- B0: Dimension designed to accommodate the component length
- C0: Dimension designed to accommodate the component thickness
- W: Overall width of the carrier tape
- P: Pitch between successive cavity centers

单击下面可查看定价，库存，交付和生命周期等信息

[>>GLF\(杰夫微\)](#)