



**Product Summary**

$V_{(BR)DSS}$	$R_{DS(on)TYP}$	$I_D$
30V	1.1Ω@4V	100mA
	1.5Ω@2.5V	

**Feature**

- Low on-resistance
- Fast switching speed
- Low voltage drive makes this device ideal for Portable equipment
- Easily designed drive circuits
- Easy to parallel

**Application**

- Interfacing , Switching

**MARKING:**

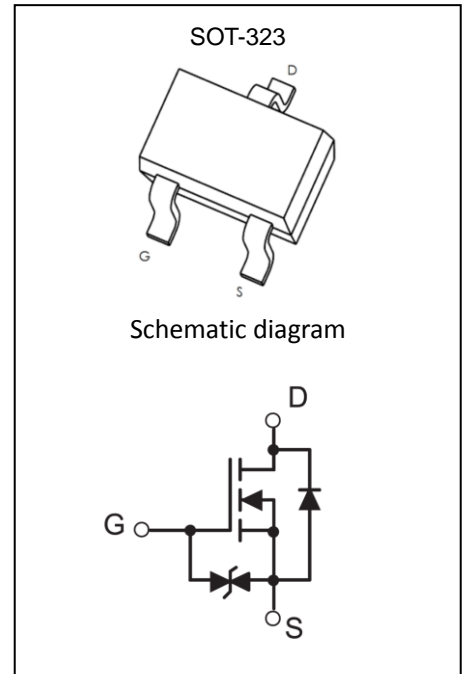
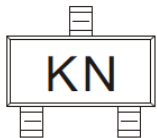

**ABSOLUTE MAXIMUM RATINGS (T<sub>a</sub>=25°C unless otherwise noted)**

Parameter	Symbol	Value	Unit
Drain-Source Voltage	$V_{DS}$	30	V
Gate-Source Voltage	$V_{GS}$	±20	V
Continuous Drain Current	$I_D$	100	mA
Power Dissipation	$P_D$	0.2	W
Thermal Resistance from Junction to Ambient	$R_{θJA}$	625	°C/W
Junction Temperature	$T_J$	150	°C
Storage Temperature	$T_{STG}$	-55~ +150	°C

**MOSFET ELECTRICAL CHARACTERISTICS(T<sub>a</sub>=25°C unless otherwise noted)**

Parameter	Symbol	Test Condition	Min	Type	Max	Unit
<b>Static Characteristics</b>						
Drain-source breakdown voltage	V <sub>(BR)DSS</sub>	V <sub>GS</sub> = 0V, I <sub>D</sub> = 10μA	30			V
Zero gate voltage drain current	I <sub>DSS</sub>	V <sub>DS</sub> = 30V, V <sub>GS</sub> = 0V			0.2	μA
Gate-body leakage current	I <sub>GSS</sub>	V <sub>GS</sub> = ±20V, V <sub>DS</sub> = 0V			±2	μA
Gate threshold voltage	V <sub>GS(th)</sub>	V <sub>DS</sub> = V <sub>GS</sub> , I <sub>D</sub> = 250μA	0.7		1.5	V
Drain-source on-resistance	R <sub>DS(on)</sub>	V <sub>GS</sub> = 4V, I <sub>D</sub> = 10mA		1.1	3.0	Ω
		V <sub>GS</sub> = 2.5V, I <sub>D</sub> = 1mA		1.5	4.2	
Forward transconductance	g <sub>FS</sub>	V <sub>DS</sub> = 3V, I <sub>D</sub> = 10mA	20			mS
<b>Dynamic characteristics*</b>						
Input Capacitance	C <sub>iss</sub>	V <sub>DS</sub> = 5V, V <sub>GS</sub> = 0V, f = 1MHz		13		pF
Output Capacitance	C <sub>oss</sub>			9		pF
Reverse Transfer Capacitance	C <sub>rss</sub>			4		pF
<b>Switching Characteristics*</b>						
Turn-on delay time	t <sub>d(on)</sub>	V <sub>GS</sub> = 5V, V <sub>DD</sub> = 5V, I <sub>D</sub> = 10mA, R <sub>g</sub> = 10Ω, R <sub>L</sub> = 500Ω,		15		ns
Rise time	t <sub>r</sub>			35		ns
Turn-off delay time	t <sub>d(off)</sub>			80		ns
Fall time	t <sub>f</sub>			80		ns

\*These parameters have no way to verify.

**Typical Characteristics**

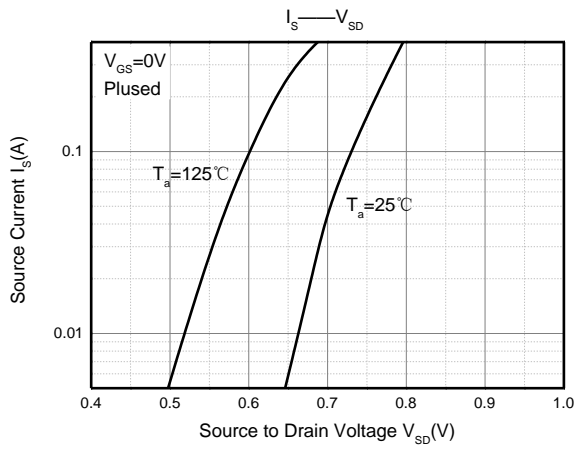
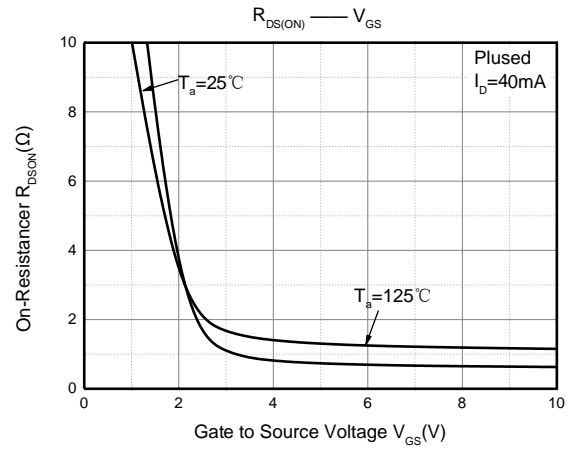
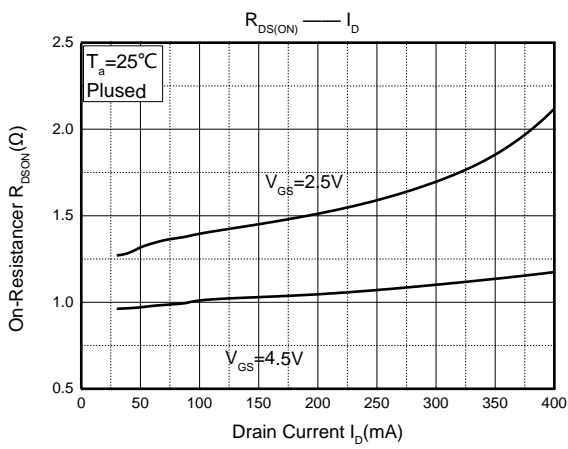
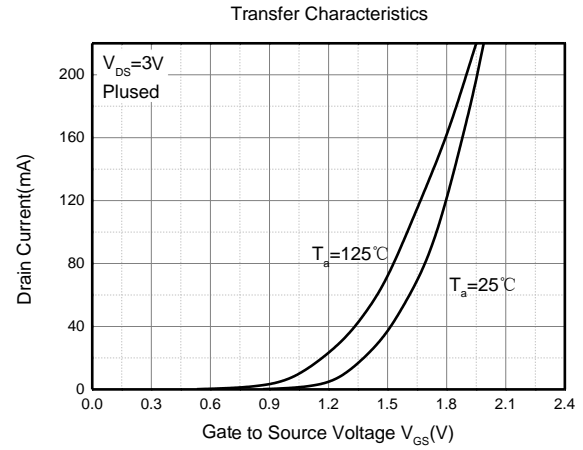
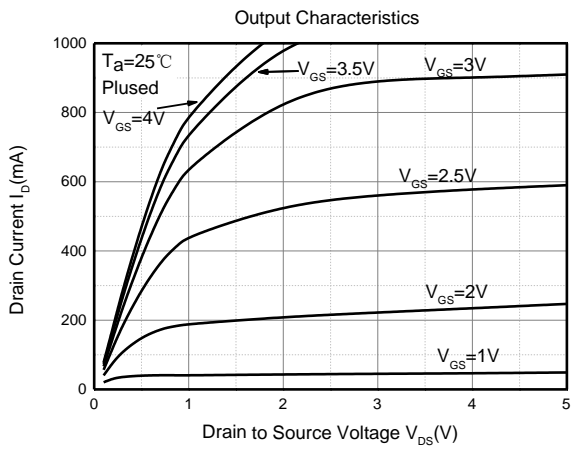

**SOT-323 Package Information**

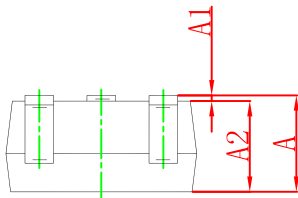
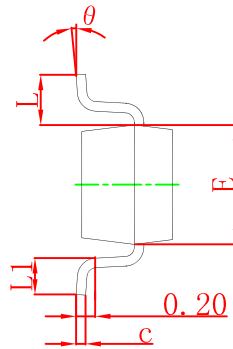
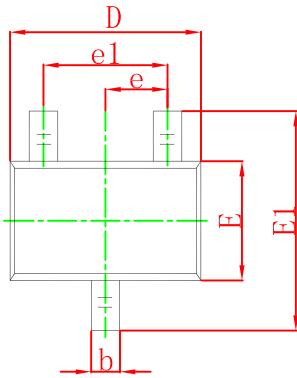

Symbol	Dimensions In Millimeters		Dimensions In Inches	
	Min	Max	Min	Max
A	0.900	1.100	0.035	0.043
A1	0.000	0.100	0.000	0.004
A2	0.900	1.000	0.035	0.039
b	0.200	0.400	0.008	0.016
c	0.080	0.150	0.003	0.006
D	2.000	2.200	0.079	0.087
E	1.150	1.350	0.045	0.053
E1	2.150	2.450	0.085	0.096
e	0.650 TYP		0.026 TYP	
e1	1.200	1.400	0.047	0.055
L	0.525 REF		0.021 REF	
L1	0.260	0.460	0.010	0.018
θ	0°	8°	0°	8°

## SOT-323 Tape and Reel

### SOT-323 Tape and reel

SOT-323 Embossed Carrier Tape

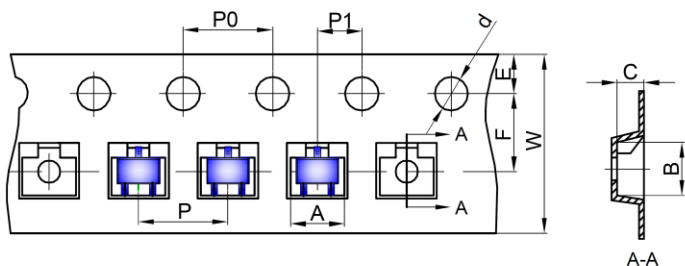

Dimensions are in millimeter										
Pkg type	A	B	C	d	E	F	P0	P	P1	W
SOT-323	2.25	2.55	1.19	Ø1.55	1.75	3.50	4.00	4.00	2.00	8.00

### SOT-323 Tape Leader and Trailer

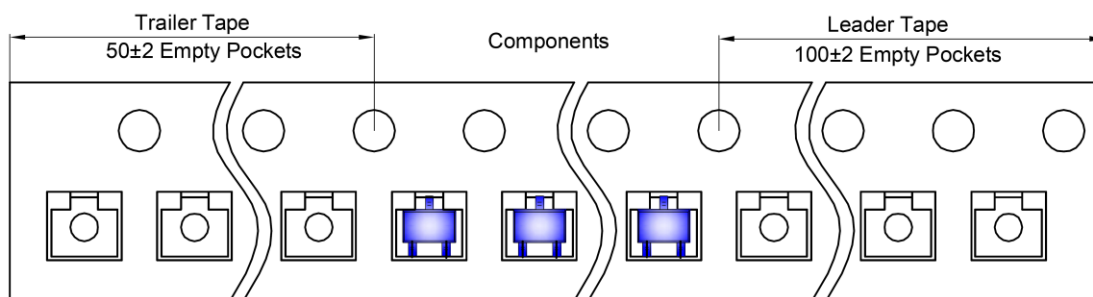

### SOT-323 Reel

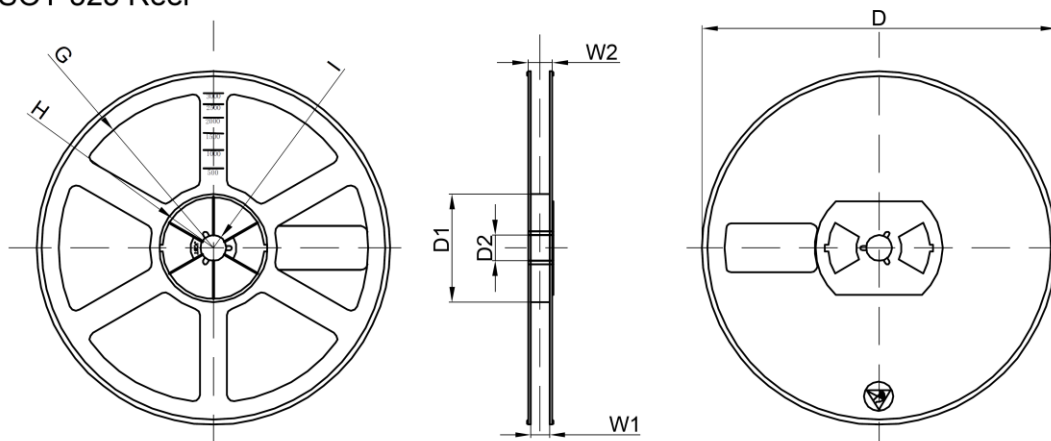

Dimensions are in millimeter								
Reel Option	D	D1	D2	G	H	I	W1	W2
7" Dia	Ø178.00	54.40	13.00	R78.00	R25.60	R6.50	9.50	12.30

REEL	Reel Size	Box	Box Size(mm)	Carton	Carton Size(mm)	G.W.(kg)
3000 pcs	7 inch	30,000 pcs	203×203×195	120,000 pcs	438×438×220	

单击下面可查看定价，库存，交付和生命周期等信息

[>>GP\(格瑞宝\)](#)