



Product Summary

$V_{(BR)DSS}$	$R_{DS(on)TYP}$	I_D
30V	1.1Ω@4.5V	100mA
	1.5Ω@2.5V	

Feature

- Low on-resistance
- Fast switching speed
- Low voltage drive makes this device ideal for Portable equipment
- Easily designed drive circuits
- Easy to parallel

Application

- Interfacing , Switching

MARKING:

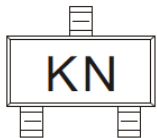

SOT-523

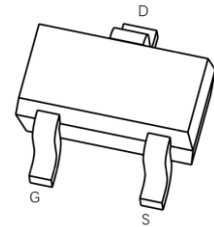

Schematic diagram

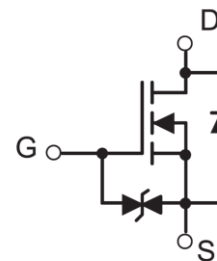

ABSOLUTE MAXIMUM RATINGS ($T_a=25^{\circ}C$ unless otherwise noted)

Parameter	Symbol	Value	Unit
Drain-Source Voltage	V_{DS}	30	V
Gate-Source Voltage	V_{GS}	±20	V
Continuous Drain Current	I_D	100	mA
Power Dissipation	P_D	0.15	W
Thermal Resistance from Junction to Ambient	$R_{\theta JA}$	833	$^{\circ}C/W$
Junction Temperature	T_J	150	$^{\circ}C$
Storage Temperature	T_{STG}	-55~ +150	$^{\circ}C$

MOSFET ELECTRICAL CHARACTERISTICS($T_a=25^{\circ}\text{C}$ unless otherwise noted)

Parameter	Symbol	Test Condition	Min	Type	Max	Unit
Static Characteristics						
Drain-source breakdown voltage	$V_{(BR)DSS}$	$V_{GS} = 0V, I_D = 10\mu A$	30			V
Zero gate voltage drain current	I_{DSS}	$V_{DS} = 30V, V_{GS} = 0V$			1	μA
Gate-body leakage current	I_{GSS}	$V_{GS} = \pm 20V, V_{DS} = 0V$			± 2	μA
Gate threshold voltage	$V_{GS(th)}$	$V_{DS} = V_{GS}, I_D = 250\mu A$	0.7		1.5	V
Drain-source on-resistance	$R_{DS(on)}$	$V_{GS} = 4.5V, I_D = 10mA$		1.1	3.0	Ω
		$V_{GS} = 2.5V, I_D = 1mA$		1.5	4.2	
Forward transconductance	g_{FS}	$V_{DS} = 3V, I_D = 10mA$	20			mS
Dynamic characteristics						
Input Capacitance	C_{iss}	$V_{DS} = 5V, V_{GS} = 0V, f = 1MHz$		13		pF
Output Capacitance	C_{oss}			9		pF
Reverse Transfer Capacitance	C_{rss}			4		pF
Switching Characteristics						
Turn-on delay time	$t_{d(on)}$	$V_{GS} = 5V, V_{DD} = 5V,$ $I_D = 10mA, R_g = 10\Omega, R_L = 500\Omega,$		15		ns
Rise time	t_r			35		ns
Turn-off delay time	$t_{d(off)}$			80		ns
Fall time	t_f			80		ns

Typical Characteristics

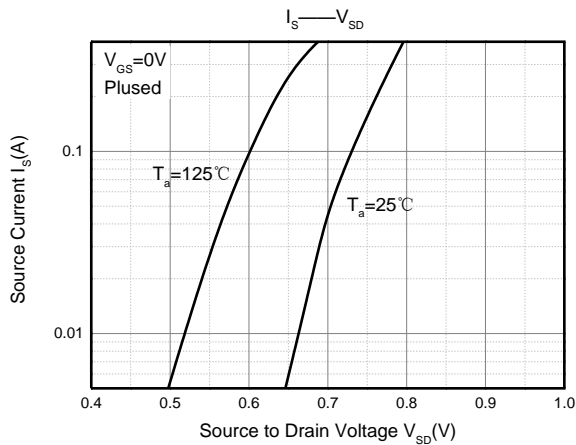
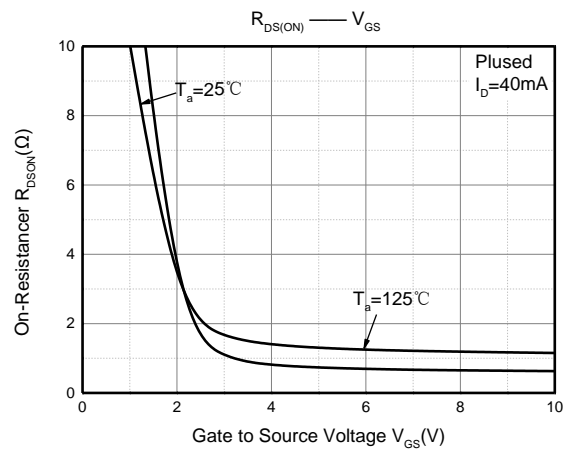
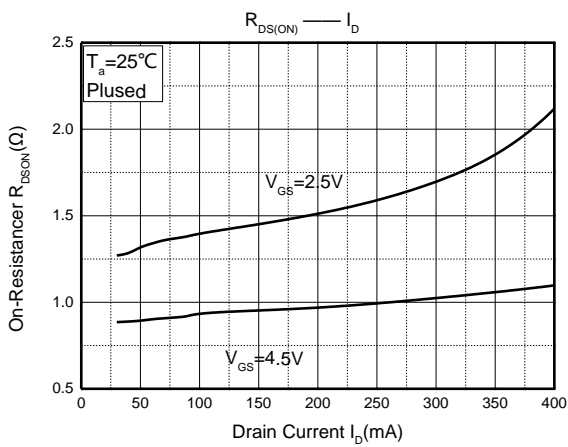
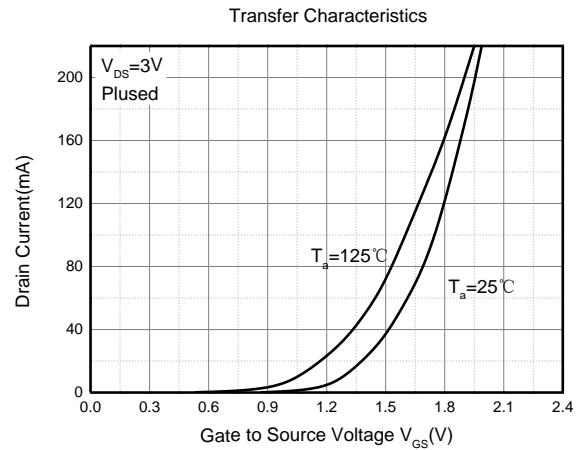
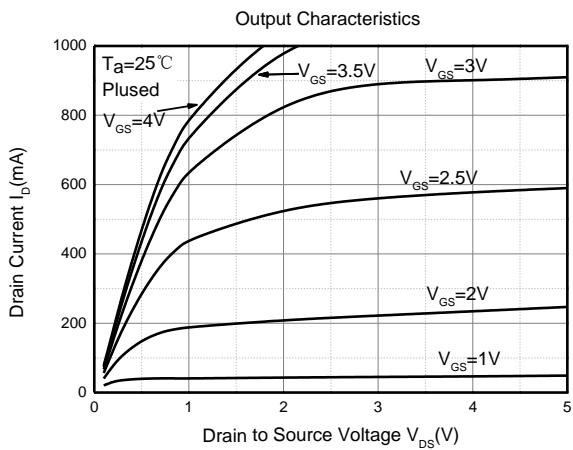

SOT-523 Package Information

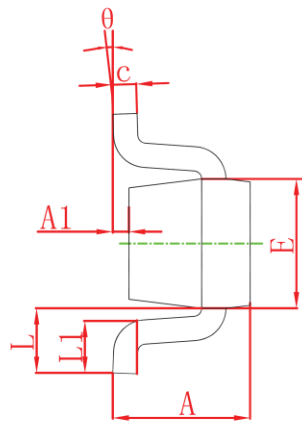
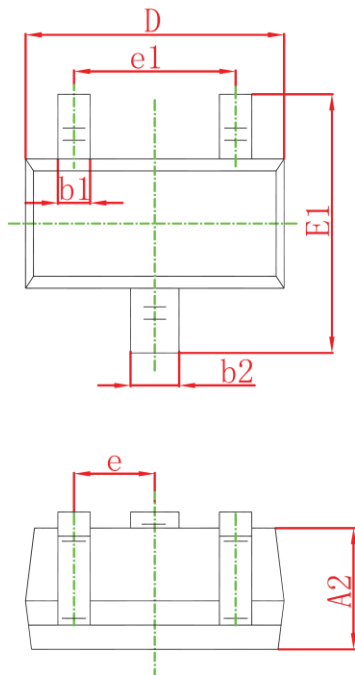

Symbol	Dimensions In Millimeters		Dimensions In Inches	
	Min.	Max.	Min.	Max.
A	0.700	0.900	0.028	0.035
A1	0.000	0.100	0.000	0.004
A2	0.700	0.800	0.028	0.031
b1	0.150	0.250	0.006	0.010
b2	0.250	0.350	0.010	0.014
c	0.100	0.200	0.004	0.008
D	1.500	1.700	0.059	0.067
E	0.700	0.900	0.028	0.035
E1	1.450	1.750	0.057	0.069
e	0.500 TYP.		0.020 TYP.	
e1	0.900	1.100	0.035	0.043
L	0.400 REF.		0.016 REF.	
L1	0.260	0.460	0.010	0.018
theta	0°	8°	0°	8°

SOT-523 Tape and Reel

SOT-523 Tape and reel

SOT-523 Embossed Carrier Tape

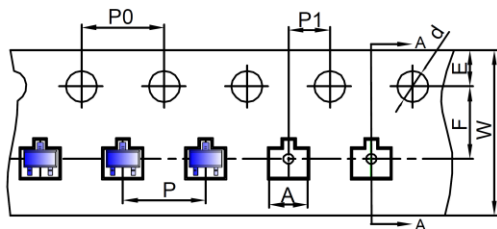

Dimensions are in millimeter										
Pkg type	A	B	C	d	E	F	P0	P	P1	W
SOT-523	1.85	1.85	0.875	Ø1.50	1.75	3.50	4.00	4.00	2.00	8.00

SOT-523 Tape Leader and Trailer

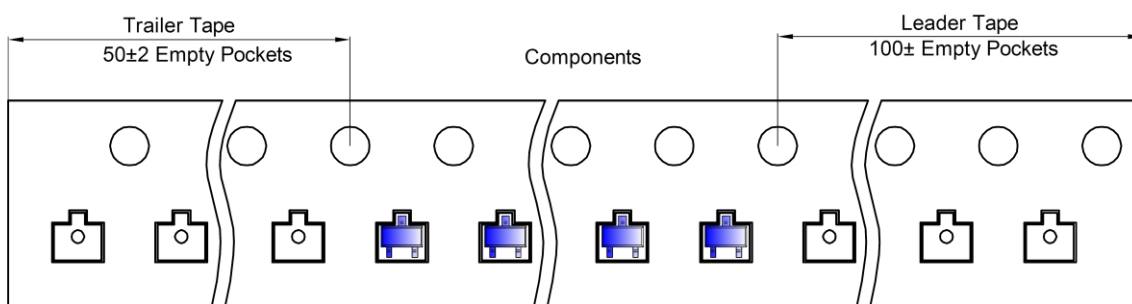

SOT-523 Reel

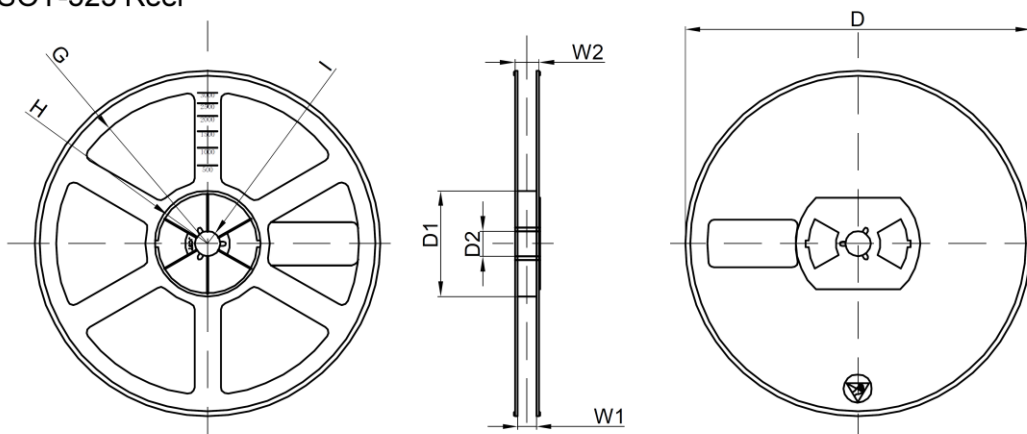

Dimensions are in millimeter									
Reel Option	D	D1	D2	G	H	I	W1	W2	
7" Dia	Ø178.00	54.40	13.00	R78.00	R25.60	R6.50	9.50	12.30	

REEL	Reel Size	Box	Box Size(mm)	Carton	Carton Size(mm)	G.W.(kg)
3000 pcs	7 inch	30,000 pcs	203×203×195	120,000 pcs	438×438×220	

单击下面可查看定价，库存，交付和生命周期等信息

[>>GP\(格瑞宝\)](#)