



## B772 TRANSISTOR (PNP)

### FEATURE

- Low speed switching

### MAXIMUM RATINGS (T<sub>a</sub>=25°C unless otherwise noted)

Symbol	Parameter	Value	Unit
V <sub>CBO</sub>	Collector-Base Voltage	-40	V
V <sub>CEO</sub>	Collector-Emitter Voltage	-30	V
V <sub>EBO</sub>	Emitter-Base Voltage	-6	V
I <sub>C</sub>	Collector Current -Continuous	-3	A
P <sub>C</sub>	Collector Power Dissipation	0.5	W
R <sub>θJA</sub>	Thermal Resistance, Junction to Ambient	250	°C/W
T <sub>J</sub> , T <sub>stg</sub>	Operation Junction and Storage Temperature Range	-55~150	°C

### SOT-89-3L

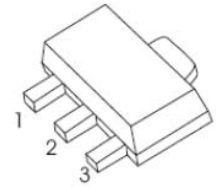

1. BASE

2. COLLECTOR

3. EMITTER

### ELECTRICAL CHARACTERISTICS (T<sub>a</sub>=25°C unless otherwise specified)

Parameter	Symbol	Test conditions	Min	Typ	Max	Unit
Collector-base breakdown voltage	V <sub>(BR)CBO</sub>	I <sub>C</sub> =-100μA, I <sub>E</sub> =0	-40			V
Collector-emitter breakdown voltage	V <sub>(BR)CEO</sub>	I <sub>C</sub> = -10mA, I <sub>B</sub> =0	-30			V
Emitter-base breakdown voltage	V <sub>(BR)EBO</sub>	I <sub>E</sub> = -100μA, I <sub>C</sub> =0	-6			V
Collector cut-off current	I <sub>CBO</sub>	V <sub>CB</sub> = -40V, I <sub>E</sub> =0			-1	μA
Collector cut-off current	I <sub>CEO</sub>	V <sub>CE</sub> =-30V, I <sub>B</sub> =0			-10	μA
Emitter cut-off current	I <sub>EBO</sub>	V <sub>EB</sub> =-6V, I <sub>C</sub> =0			-1	μA
DC current gain	h <sub>FE</sub>	V <sub>CE</sub> = -2V, I <sub>C</sub> = -1A	60		400	
Collector-emitter saturation voltage	V <sub>CE(sat)</sub>	I <sub>C</sub> =-2A, I <sub>B</sub> = -0.2A			-0.5	V
Base-emitter saturation voltage	V <sub>BE(sat)</sub>	I <sub>C</sub> =-2A, I <sub>B</sub> = -0.2A			-1.5	V
Transition frequency	f <sub>T</sub>	V <sub>CE</sub> = -5V, I <sub>C</sub> =-0.1A f =10MHz	50			MHz

### CLASSIFICATION OF h<sub>FE</sub>

Rank	R	O	Y	GR
Range	60-120	100-200	160-320	200-400

Typical Characteristics

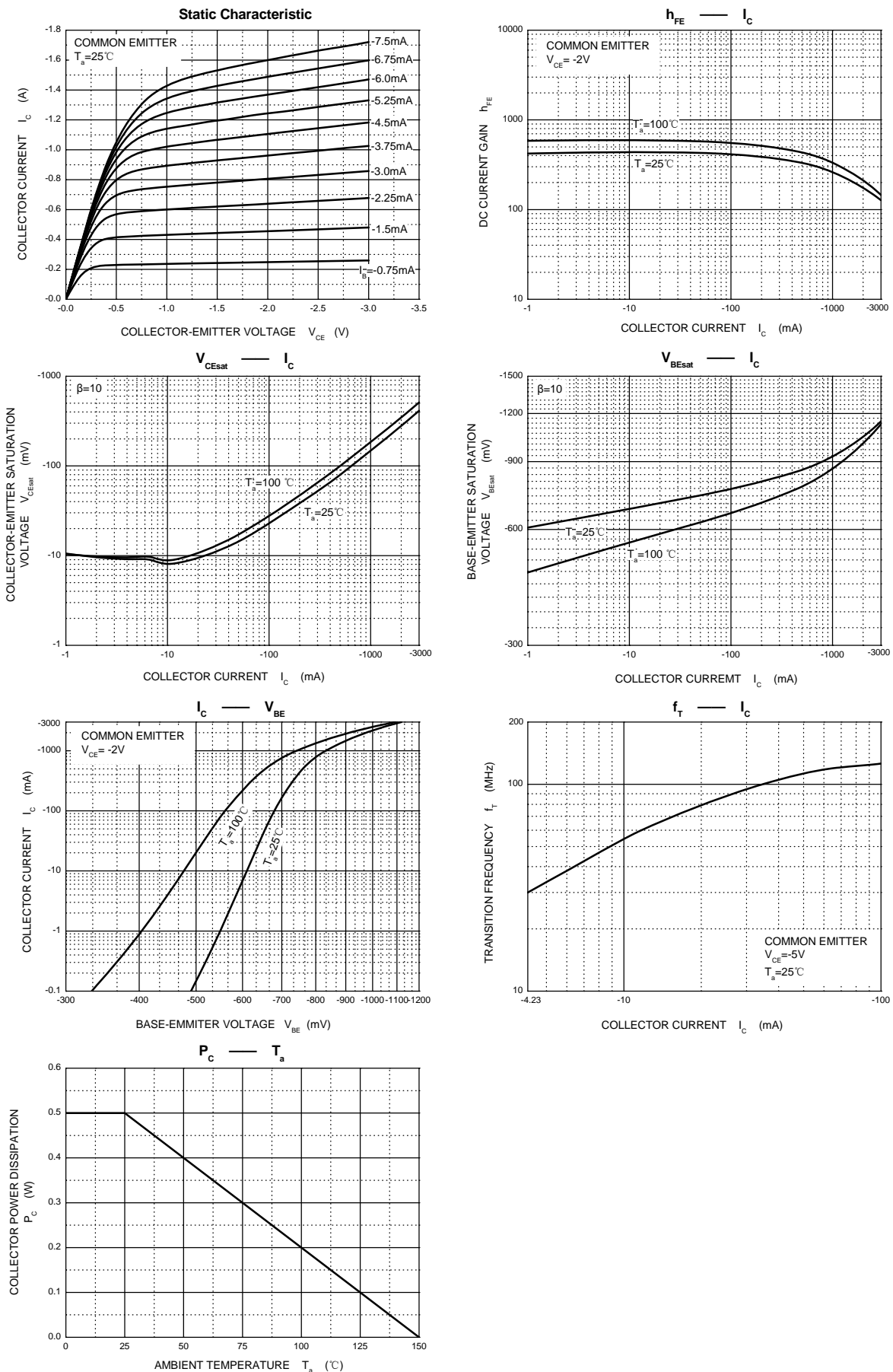

**SOT-89-3L Package Outline Dimensions**

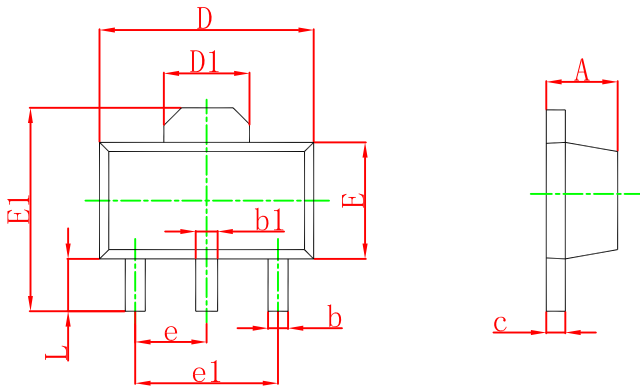

Symbol	Dimensions In Millimeters		Dimensions In Inches	
	Min	Max	Min	Max
A	1.400	1.600	0.055	0.063
b	0.320	0.520	0.013	0.020
b1	0.400	0.580	0.016	0.023
c	0.350	0.440	0.014	0.017
D	4.400	4.600	0.173	0.181
D1	1.550 REF.		0.061 REF.	
E	2.300	2.600	0.091	0.102
E1	3.940	4.250	0.155	0.167
e	1.500 TYP.		0.060 TYP.	
e1	3.000 TYP.		0.118 TYP.	
L	0.900	1.200	0.035	0.047

**SOT-89-3L Suggested Pad Layout**

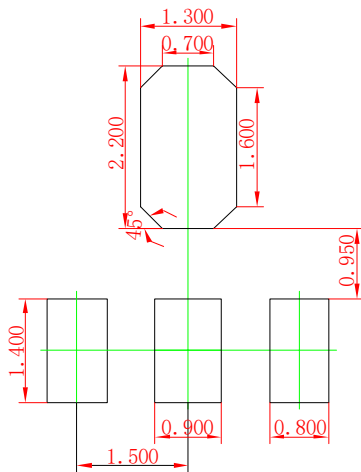

- Note:
1. Controlling dimension: in millimeters.
  2. General tolerance:  $\pm 0.05\text{mm}$ .
  3. The pad layout is for reference purposes only.

**SOT-89-3L Tape and Reel**

**SOT-89-3L Embossed Carrier Tape**

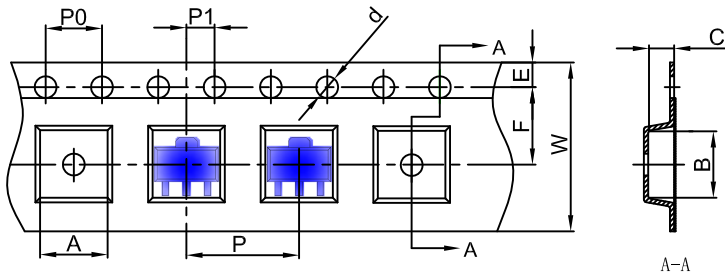

Dimensions are in millimeter										
Pkg type	A	B	C	d	E	F	P0	P	P1	W
SOT-89-3L	4.85	4.45	1.85	Ø1.50	1.75	5.50	4.00	8.00	2.00	12.00

**SOT-89-3L Tape Leader and Trailer**

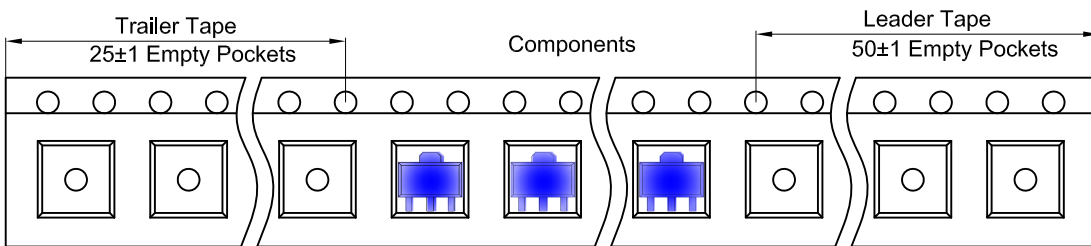

**SOT-89-3L Reel**

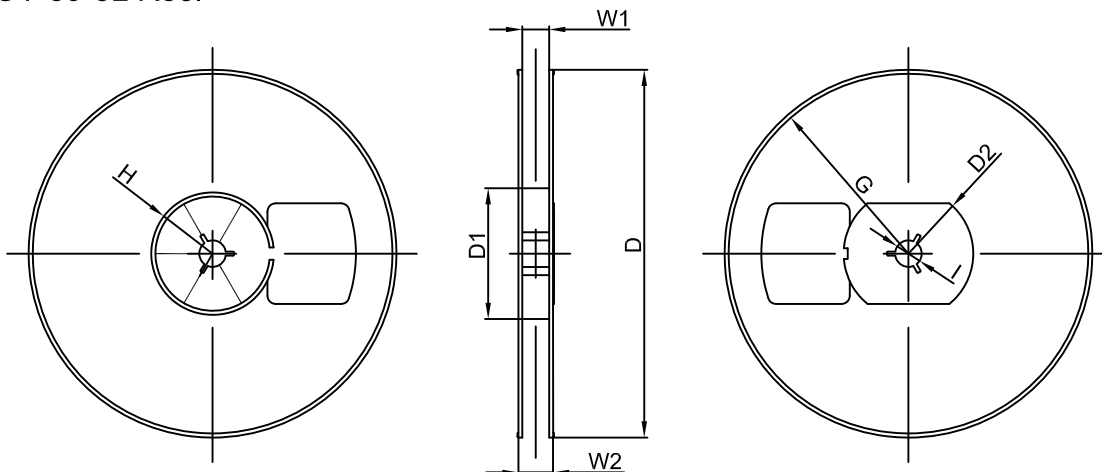

Dimensions are in millimeter								
Reel Option	D	D1	D2	G	H	I	W1	W2
7" Dia	Ø180.00	60.00	R32.00	R86.50	R30.00	Ø13.00	13.20	16.50

REEL	Reel Size	Box	Box Size(mm)	Carton	Carton Size(mm)	G.W.(kg)
1000 pcs	7 inch	10,000 pcs	203×203×195	40,000 pcs	438×438×220	

单击下面可查看定价，库存，交付和生命周期等信息

[>>GP\(格瑞宝\)](#)