



### Product Summary

$V_{(BR)DSS}$	$R_{DS(on)TYP}$	$I_D$
100V	6.7mΩ@10V	80A

### Feature

- Split Gate Trench Technology
- Low  $R_{DS(ON)}$
- Low Gate Charge
- Low Gate Resistance
- 100% UIS Tested

### Application

- Industrial Power Supply
- Load Switch

### MARKING:

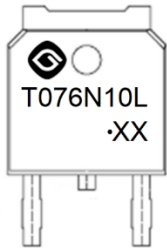

T076N10L = Device Code  
XX = Date Code  
Solid Dot = Green Indicator

### TO-252-2L

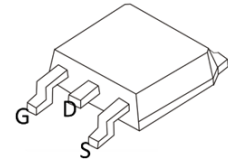

### Schematic diagram

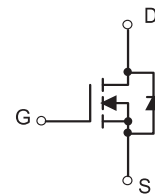

### ABSOLUTE MAXIMUM RATINGS ( $T_A = 25^\circ\text{C}$ unless otherwise noted)

Parameter	Symbol	Value	Unit
Drain - Source Voltage	$V_{DS}$	100	V
Gate - Source Voltage	$V_{GS}$	±20	V
Continuous Drain Current <sup>1</sup>	$I_D$	80	A
Pulsed Drain Current <sup>2</sup>	$I_{DM}$	320	A
Single Pulsed Avalanche Current <sup>3</sup>	$I_{AS}$	39	A
Single Pulsed Avalanche Energy <sup>3</sup>	$E_{AS}$	380	mJ
Power Dissipation <sup>5</sup>	$P_D$	89	W
Thermal Resistance from Junction to Ambient <sup>6</sup>	$R_{\theta JA}$	50	$^\circ\text{C}/\text{W}$
Thermal Resistance from Junction to Case	$R_{\theta JC}$	1.4	$^\circ\text{C}/\text{W}$
Junction Temperature	$T_J$	150	$^\circ\text{C}$
Storage Temperature	$T_{STG}$	-55~ +150	$^\circ\text{C}$

**MOSFET ELECTRICAL CHARACTERISTICS ( $T_J = 25^\circ\text{C}$  unless otherwise noted)**

Parameter	Symbol	Test Condition	Min	Type	Max	Unit
<b>Off Characteristics</b>						
Drain - Source Breakdown Voltage	$V_{(BR)DSS}$	$V_{GS} = 0V, I_D = 250\mu A$	100			V
Zero Gate Voltage Drain Current	$I_{DSS}$	$V_{DS} = 80V, V_{GS} = 0V$			1	$\mu A$
Gate - Body Leakage Current	$I_{GSS}$	$V_{GS} = \pm 20V, V_{DS} = 0V$			$\pm 100$	nA
<b>On Characteristics<sup>4</sup></b>						
Gate Threshold Voltage	$V_{GS(th)}$	$V_{DS} = V_{GS}, I_D = 250\mu A$	1	2	3	V
Drain-source On-resistance	$R_{DS(on)}$	$V_{GS} = 10V, I_D = 20A$		6.7	7.7	m $\Omega$
Forward Transconductance	$g_{FS}$	$V_{DS} = 10V, I_D = 10A$		29		S
<b>Dynamic Characteristics</b>						
Input Capacitance	$C_{iss}$	$V_{DS} = 50V, V_{GS} = 0V, f = 1MHz$		2915		pF
Output Capacitance	$C_{oss}$			370		
Reverse Transfer Capacitance	$C_{rss}$			16		
Gate Resistance	$R_g$	$V_{DS} = 0V, V_{GS} = 0V, f = 1MHz$		1.2		$\Omega$
<b>Switching Characteristics</b>						
Total Gate Charge	$Q_g$	$V_{DS} = 50V, V_{GS} = 10V, I_D = 45A$		55		nC
Gate-source Charge	$Q_{gs}$			18		
Gate-drain Charge	$Q_{gd}$			14		
Turn-on Delay Time	$t_{d(on)}$	$V_{DD} = 50V, V_{GS} = 10V, R_L = 1.2\Omega$ $R_G = 3\Omega$		15		ns
Turn-on Rise Time	$t_r$			10		
Turn-off Delay Time	$t_{d(off)}$			32		
Turn-off Fall Time	$t_f$			10		
<b>Source - Drain Diode Characteristics</b>						
Diode Forward Voltage <sup>4</sup>	$V_{SD}$	$V_{GS} = 0V, I_S = 10A$			1.2	V

Notes :

- 1.The maximum current rating is limited by package.And device mounted on a large heatsink
- 2.Pulse Test : Pulse Width  $\leq 10\mu s$ , duty cycle  $\leq 1\%$ .
- 3.EAS condition:  $V_{DD} = 50V, V_{GS} = 10V, L = 0.5mH, R_G = 25\Omega$  Starting  $T_J = 25^\circ\text{C}$ .
- 4.Pulse Test : Pulse Width  $\leq 300\mu s$ , duty cycle  $\leq 2\%$ .
- 5.The power dissipation  $P_D$  is limited by  $T_{J(MAX)} = 150^\circ\text{C}$ .And device mounted on a large heatsink
- 6.Device mounted on  $1in^2$  FR-4 board with 2oz. Copper, in a still air environment with  $T_A = 25^\circ\text{C}$ .

## Typical Characteristics

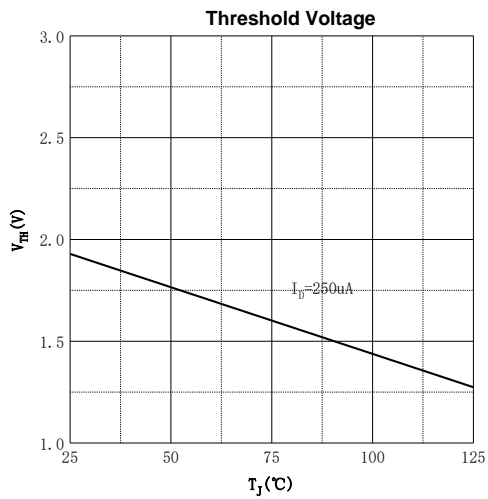
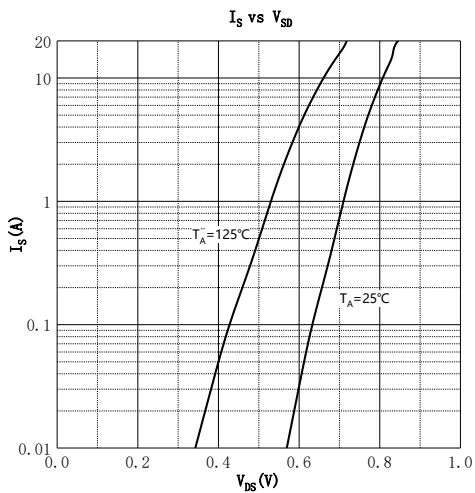
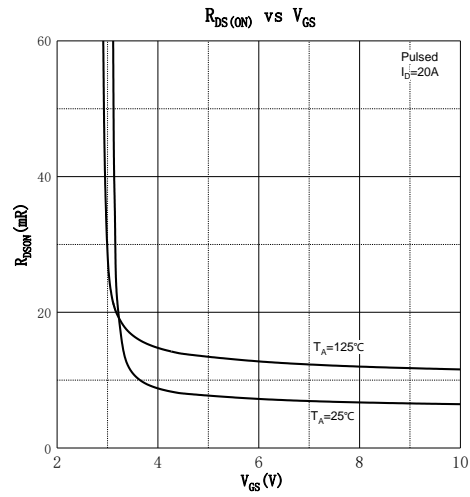
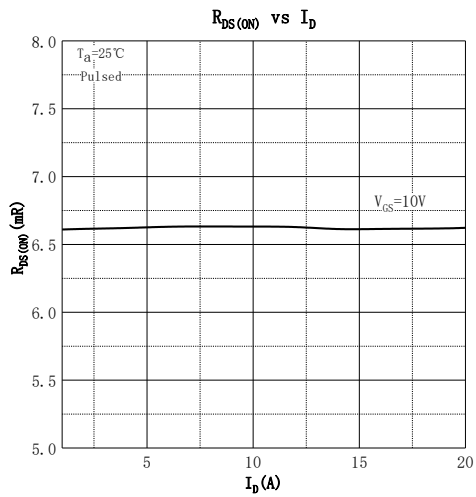
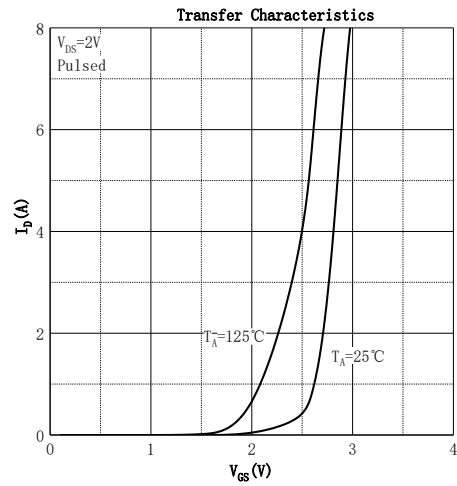
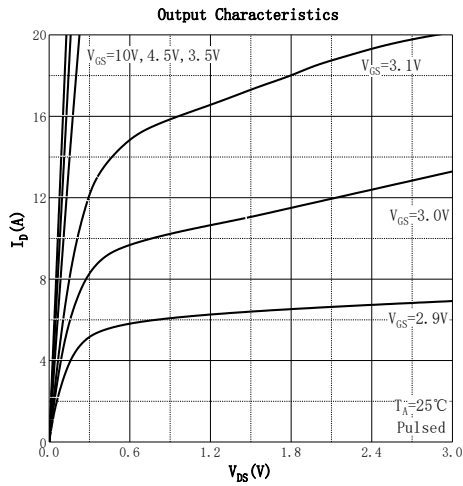

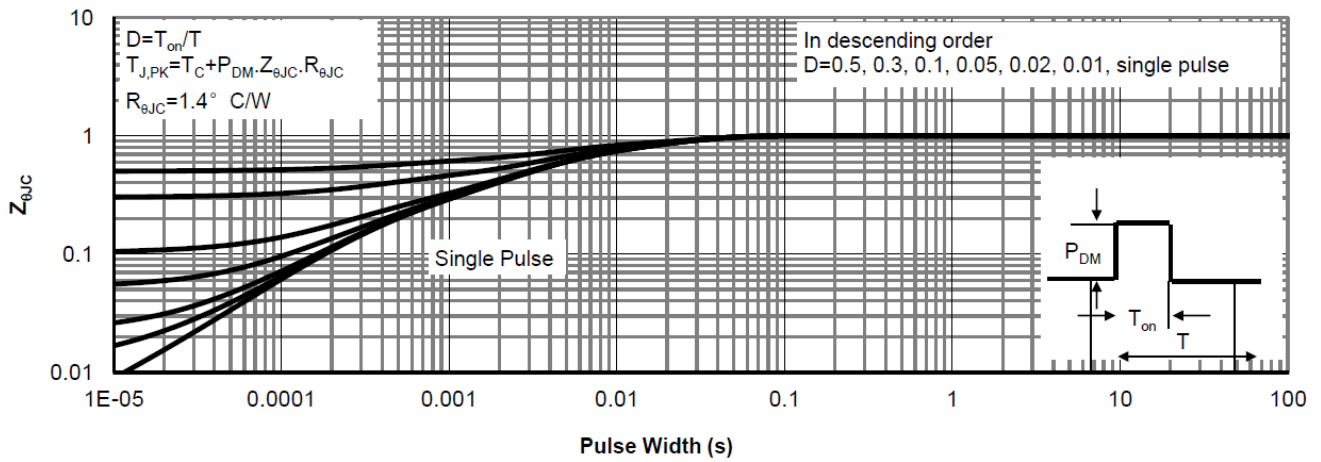
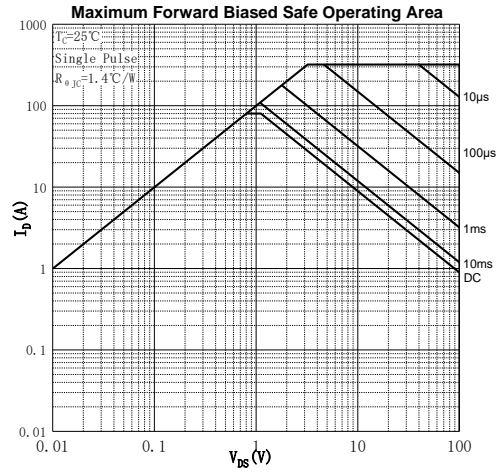
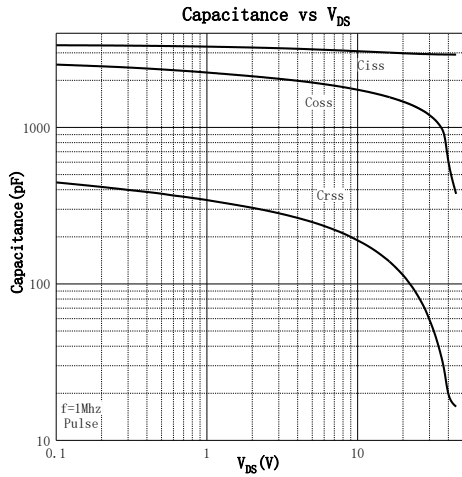

## TO-252-2L Package Information

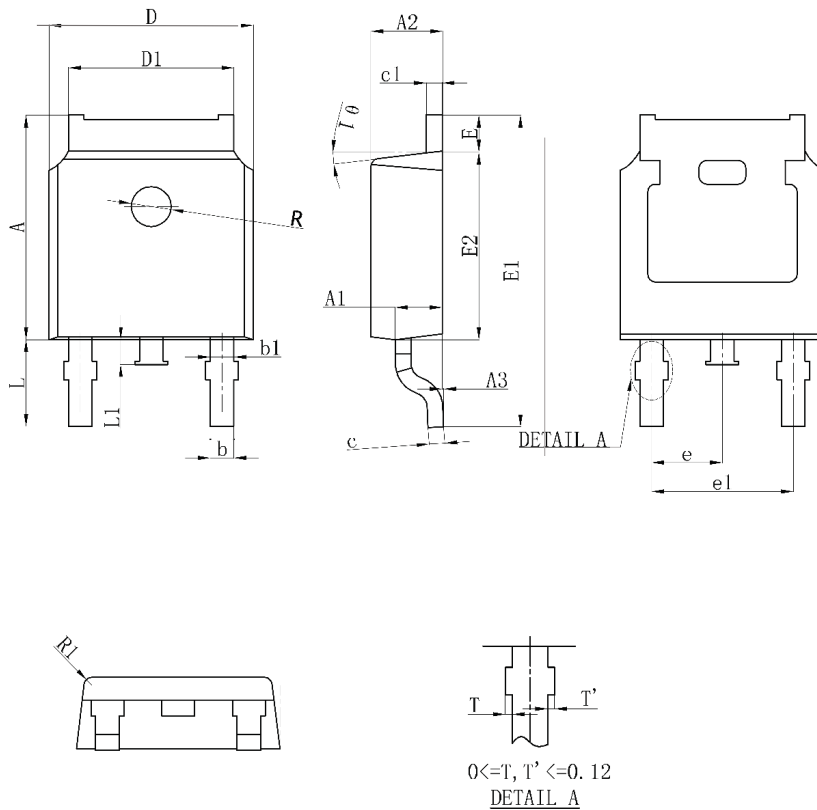

Symbol	Dimensions In Millimeters		Dimensions In Inches	
	Min.	Max.	Min.	Max.
A	7.050	7.150	0.278	0.281
A1	0.960	1.060	0.038	0.042
A2	2.200	2.400	0.087	0.094
A3	0.000	0.100	0.000	0.004
b	0.760REF		0.030REF	
b1	1.000REF		0.039REF	
c	0.508REF		0.020REF	
c1	0.508REF		0.020REF	
D	6.550	6.650	0.258	0.262
D1	5.100	5.460	0.201	0.215
E	0.950	1.050	0.037	0.041
E1	9.700	10.400	0.382	0.409
E2	6.000	6.200	0.236	0.244
e	2.286BSC		0.090BSC	
e1	4.572REF		0.180REF	
L	2.650	2.950	0.104	0.116
L1	0.700	0.900	0.028	0.035
theta	7°REF		7°REF	
R	1.300REF		0.051REF	
R1	0.250REF		0.010REF	

单击下面可查看定价，库存，交付和生命周期等信息

[>>GP\(格瑞宝\)](#)