



Product Summary

$V_{(BR)DSS}$	$R_{DS(on)TYP}$	I_D
-30V	45mΩ@-10V	-4.1A
	57mΩ@-4.5V	

Feature

- Trench Technology Power MOSFET
- Low $R_{DS(ON)}$
- Low Gate Charge
- Low Gate Resistance

Application

- Load Switch
- PWM Applications

MARKING:

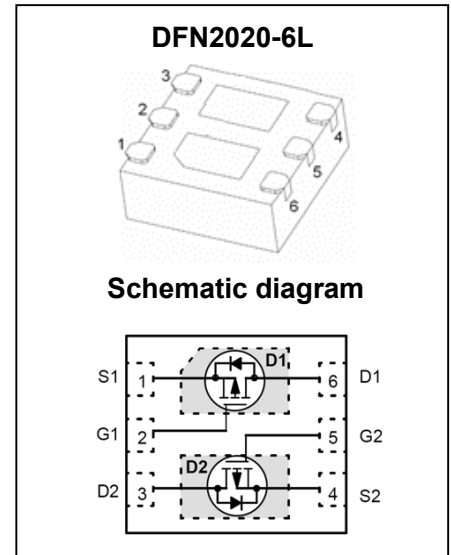

ABSOLUTE MAXIMUM RATINGS ($T_A = 25^\circ\text{C}$ unless otherwise noted)

Parameter	Symbol	Value	Unit
Drain - Source Voltage	V_{DS}	-30	V
Gate - Source Voltage	V_{GS}	± 20	V
Continuous Drain Current ^{1,5}	I_D	-4.1	A
	$T_A = 25^\circ\text{C}$		
Pulsed Drain Current ²	I_{DM}	-33.6	A
Power Dissipation ^{4,5}	P_D	2	W
	$T_A = 25^\circ\text{C}$		
Thermal Resistance from Junction to Ambient ⁵	$R_{\theta JA}$	62.5	$^\circ\text{C/W}$
Junction Temperature	T_J	150	$^\circ\text{C}$
Storage Temperature	T_{STG}	-55~ +150	$^\circ\text{C}$

MOSFET ELECTRICAL CHARACTERISTICS ($T_J = 25^\circ\text{C}$ unless otherwise noted)

Parameter	Symbol	Test Condition	Min	Type	Max	Unit
Off Characteristics						
Drain - Source Breakdown Voltage	$V_{(BR)DSS}$	$V_{GS} = 0V, I_D = -250\mu A$	-30			V
Zero Gate Voltage Drain Current	I_{DSS}	$V_{DS} = -24V, V_{GS} = 0V$			-1	μA
Gate - Body Leakage Current	I_{GSS}	$V_{GS} = \pm 20V, V_{DS} = 0V$			± 100	nA
On Characteristics³						
Gate Threshold Voltage	$V_{GS(th)}$	$V_{DS} = V_{GS}, I_D = -250\mu A$	-1	-1.6	-3	V
Drain-source On-resistance	$R_{DS(on)}$	$V_{GS} = -10V, I_D = -4.2A$		45	60	m Ω
		$V_{GS} = -4.5V, I_D = -3A$		57	87	
Forward Transconductance	g_{FS}	$V_{DS} = -5V, I_D = -4A$	5			S
Dynamic Characteristics						
Input Capacitance	C_{iss}	$V_{DS} = -15V, V_{GS} = 0V, f = 1MHz$		572		pF
Output Capacitance	C_{oss}			65		
Reverse Transfer Capacitance	C_{rss}			57		
Switching Characteristics						
Total Gate Charge	Q_g	$V_{DS} = -15V, V_{GS} = -10V, I_D = -4.2A$		10		nC
Gate-source Charge	Q_{gs}			2		
Gate-drain Charge	Q_{gd}			3.4		
Turn-on Delay Time	$t_{d(on)}$	$V_{DD} = -15V, V_{GS} = -10V,$ $R_L = 3.65\Omega, R_G = 3\Omega$		8		ns
Turn-on Rise Time	t_r			6.2		
Turn-off Delay Time	$t_{d(off)}$			25		
Turn-off Fall Time	t_f			10		
Source - Drain Diode Characteristics						
Diode Forward Voltage ³	V_{SD}	$V_{GS} = 0V, I_S = -2A$			1.2	V

Notes :

- 1.The maximum current rating is limited by package.
- 2.Pulse Test : Pulse Width $\leq 10\mu s$, duty cycle $\leq 1\%$.
- 3.Pulse Test : Pulse Width $\leq 300\mu s$, duty cycle $\leq 2\%$.
- 4.The power dissipation P_D is limited by $T_{J(MAX)} = 150^\circ\text{C}$.
- 5.Device mounted on 1in² FR-4 board with 2oz. Copper, in a still air environment with $T_A = 25^\circ\text{C}$.

Typical Characteristics

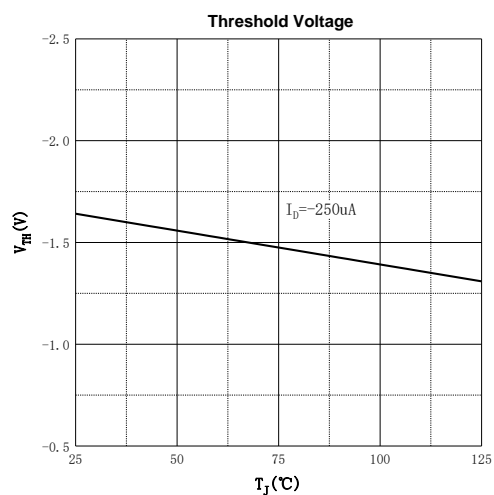
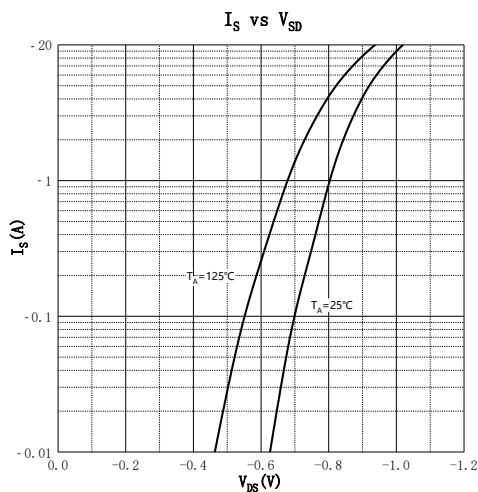
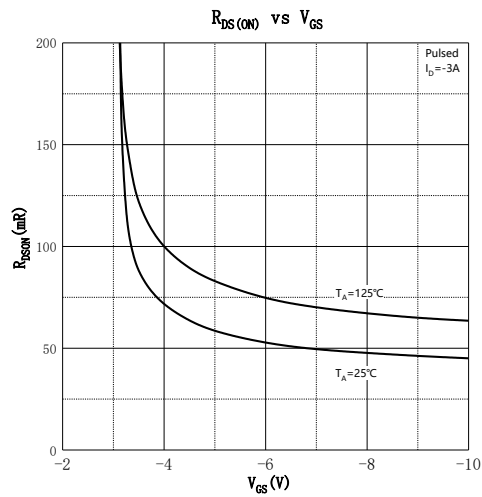
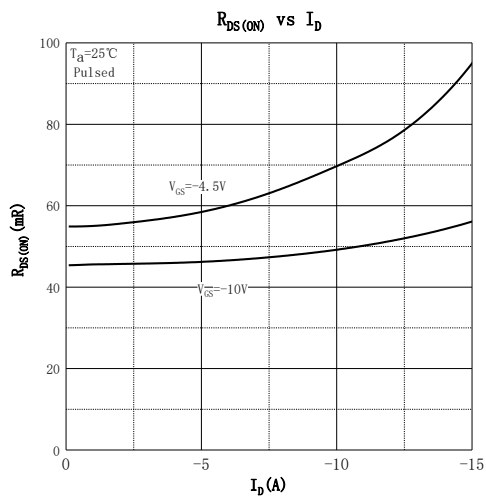
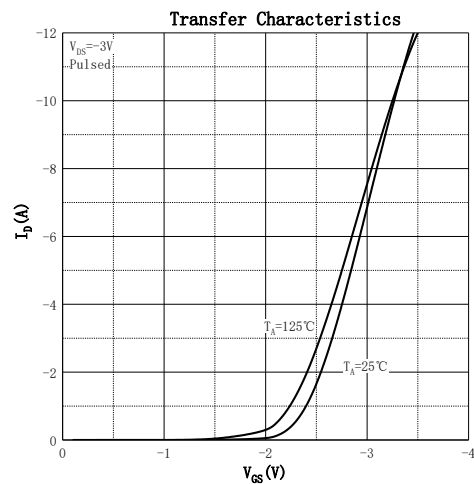
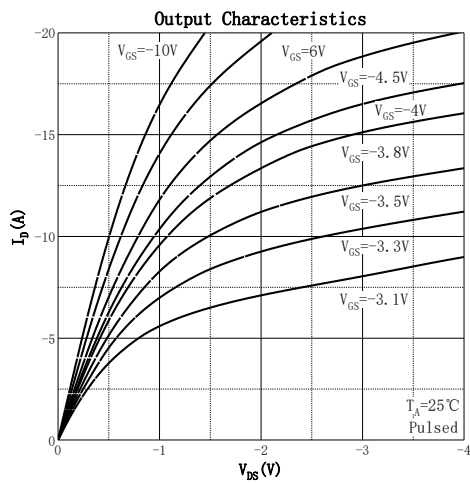

DFN2020-6L Package Information

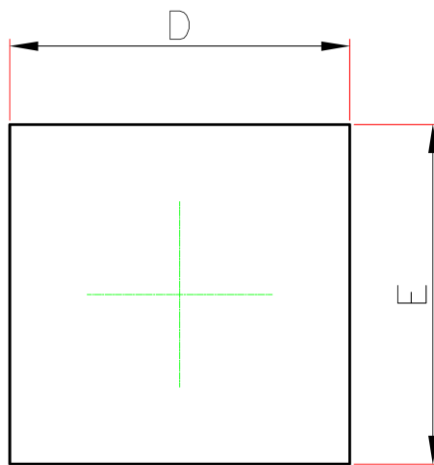

TOP VIEW

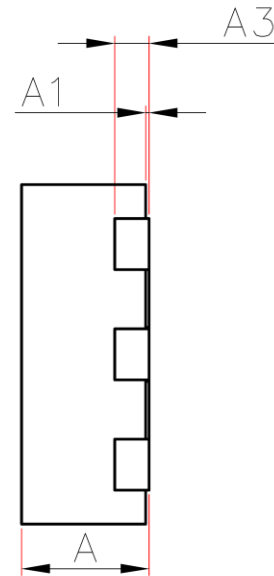

SIDE VIEW

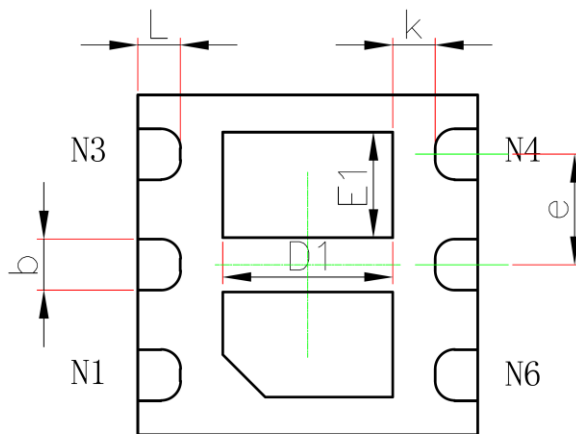

BOTTOM VIEW

Symbol	Dimensions In Millimeters		Dimensions In Inches	
	Min.	Max.	Min.	Max.
A	0.700	0.800	0.028	0.031
A1	0	0.050	0	0.002
A3	2.03REF		0.008REF	
D	1.900	2.100	0.075	0.083
E	1.900	2.100	0.075	0.083
D1	0.900	1.100	0.035	0.043
E1	0.520	0.720	0.020	0.028
k	0.200MIN		0.008MIN	
b	0.250	0.350	0.010	0.014
e	0.65BSC		0.026TYP	
L	0.174	0.326	0.007	0.013

单击下面可查看定价，库存，交付和生命周期等信息

[>>GP\(格瑞宝\)](#)