

Product Summary

V _{(BR)DSS}	R _{DS(on)TYP}	I _D
60V	1.9Ω@10V	340mA
	2.3Ω@4.5V	

Feature

- High density cell design for Low R_{DS(on)}
- Voltage controlled small signal switch
- Rugged and reliable
- ESD protected Gate HBM 2.5KV

Application

- DC/DC Converter
- Load Switch for Portable Devices
- Battery Switch

MARKING:

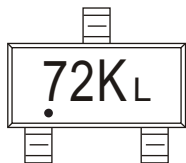

72K_L=Device code
 Solid dot = Green molding compound device,if none,the normal device.

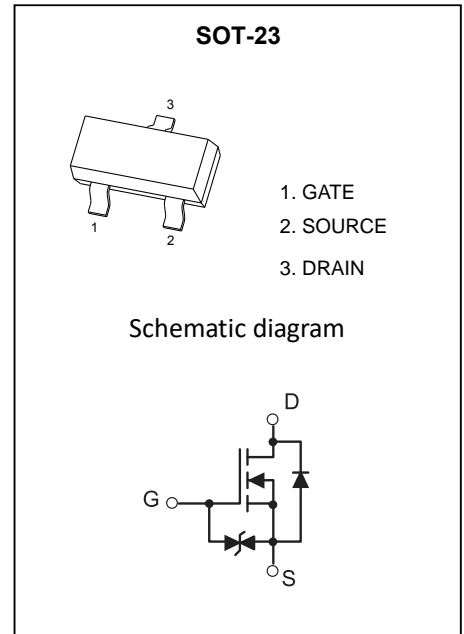

ABSOLUTE MAXIMUM RATINGS (T_a=25°C unless otherwise noted)

Parameter	Symbol	Value	Unit
Drain-Source Voltage	V _{DS}	60	V
Gate-Source Voltage	V _{GS}	±20	V
Continuous Drain Current	I _D	340	mA
Power Dissipation	P _D	0.35	W
Thermal Resistance from Junction to Ambient	R _{θJA}	357	°C/W
Junction Temperature	T _J	150	°C
Storage Temperature	T _{STG}	-55~ +150	°C

MOSFET ELECTRICAL CHARACTERISTICS($T_a=25^{\circ}\text{C}$ unless otherwise noted)

Parameter	Symbol	Test Condition	Min	Type	Max	Unit
Static Characteristics						
Drain-source breakdown voltage	$V_{(BR)DSS}$	$V_{GS} = 0V, I_D = 250\mu A$	60			V
Zero gate voltage drain current	I_{DSS}	$V_{DS} = 48V, V_{GS} = 0V$			1	μA
Gate-body leakage current	I_{GSS1}	$V_{GS} = \pm 20V, V_{DS} = 0V$			± 10	μA
	I_{GSS2}	$V_{GS} = \pm 10V, V_{DS} = 0V$			± 200	nA
	I_{GSS2}	$V_{GS} = \pm 5V, V_{DS} = 0V$			± 100	nA
Gate threshold voltage*	$V_{GS(th)}$	$V_{DS} = V_{GS}, I_D = 250\mu A$	1	1.6	2.5	V
Drain-source on-resistance*	$R_{DS(on)}$	$V_{GS} = 10V, I_D = 500mA$		1.9	3.5	Ω
		$V_{GS} = 4.5V, I_D = 200mA$		2.3	4	
Recovered charge	Q_r	$V_{GS}=0V, I_S=300mA, V_R=25V, dl_s/d_t=-100A/\mu S$		30		nC
Dynamic characteristics**						
Input Capacitance	C_{iss}	$V_{DS}=10V, V_{GS}=0V, f=1MHz$			40	pF
Output Capacitance	C_{oss}				30	
Reverse Transfer Capacitance	C_{rss}				10	
Switching Characteristics**						
Turn-on delay time	$t_{d(on)}$	$V_{GS}=10V, V_{DD}=50V, R_G=50\Omega$			10	ns
Turn-off delay time	$t_{d(off)}$	$R_{GS}=50\Omega, R_L=250\Omega$			15	
Reverse recovery Time	t_{rr}	$V_{GS}=0V, I_S=300mA, V_R=25V, dl_s/d_t=-100A/\mu S$		30		
Source-Drain Diode characteristics						
Diode Forward voltage	V_{SD}	$V_{GS} = 0V, I_S = 300mA$			1.5	V
GATE-SOURCE ZENER DIODE						
Gate-Source Breakdown Voltage	BV_{GSO}	$I_{GS} = \pm 1mA$ (Open Drain)	± 21.5		± 30	V

Notes:

*Pulse Test: Pulse Width $\leq 300\mu s$, Duty Cycle $\leq 2\%$.

**These parameters have no way to verify.

Typical Characteristics

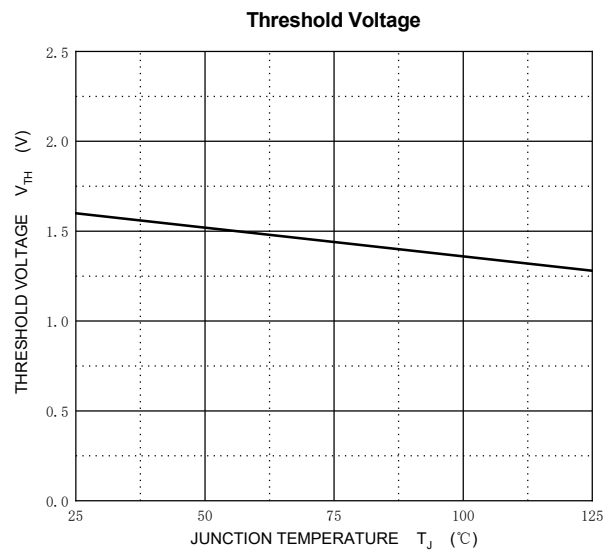
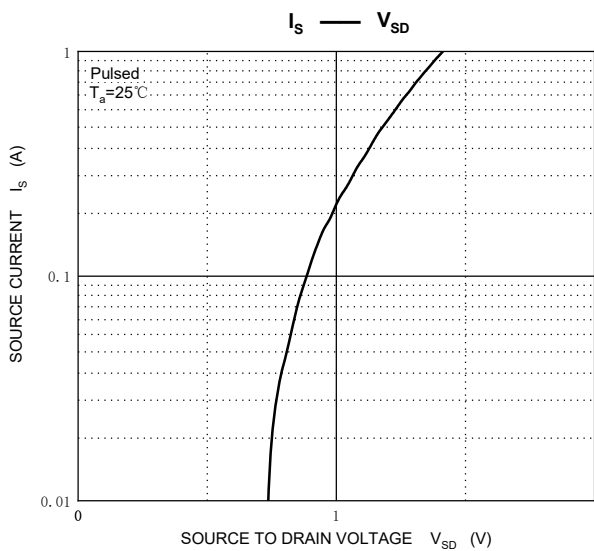
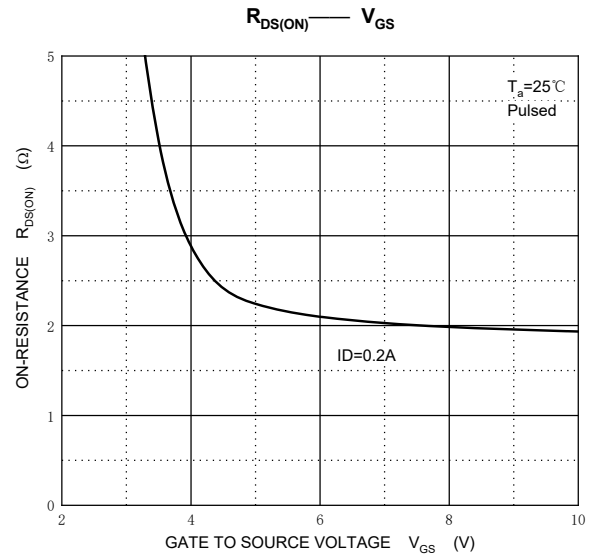
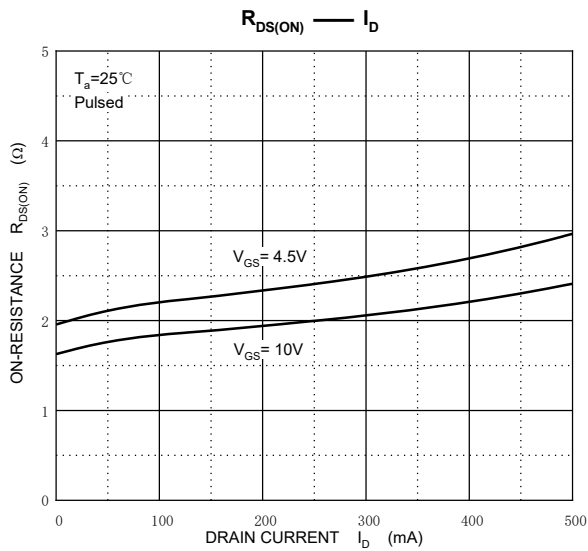
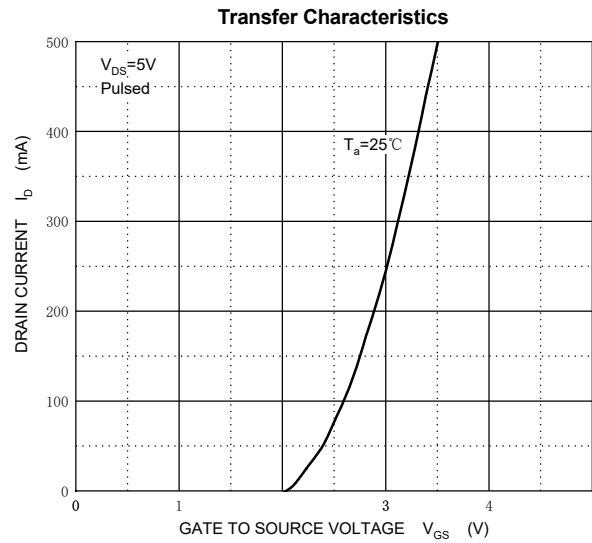
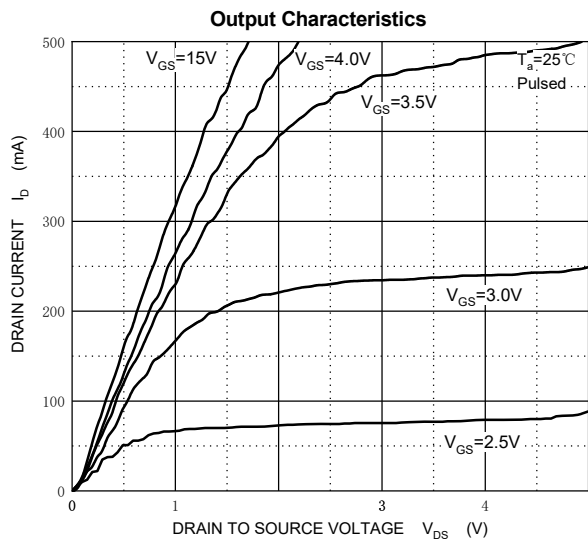

SOT-23 Package Information

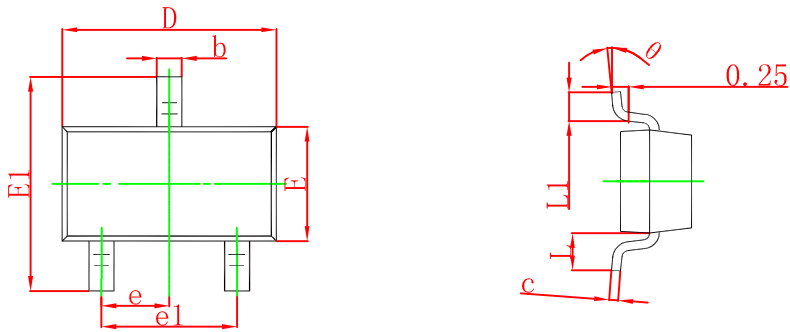

Symbol	Dimensions In Millimeters		Dimensions In Inches	
	Min	Max	Min	Max
A	0.900	1.150	0.035	0.045
A1	0.000	0.100	0.000	0.004
A2	0.900	1.050	0.035	0.041
b	0.300	0.500	0.012	0.020
c	0.080	0.150	0.003	0.006
D	2.800	3.000	0.110	0.118
E	1.200	1.400	0.047	0.055
E1	2.250	2.550	0.089	0.100
e	0.950 TYP		0.037 TYP	
e1	1.800	2.000	0.071	0.079
L	0.550 REF		0.022 REF	
L1	0.300	0.500	0.012	0.020
θ	0°	8°	0°	8°

SOT-23 Tape and Reel

SOT-23 Tape and reel

SOT-23 Embossed Carrier Tape

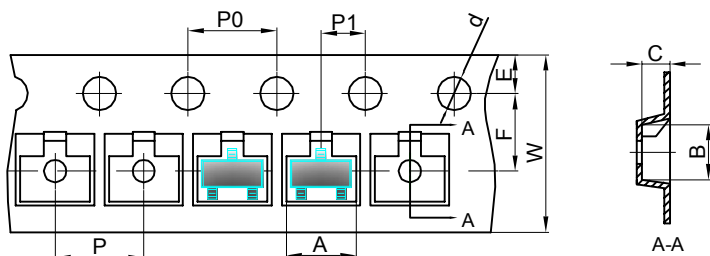

Dimensions are in millimeter										
Pkg type	A	B	C	d	E	F	P0	P	P1	W
SOT-23	3.15	2.77	1.22	Ø1.50	1.75	3.50	4.00	4.00	2.00	8.00

SOT-23 Tape Leader and Trailer

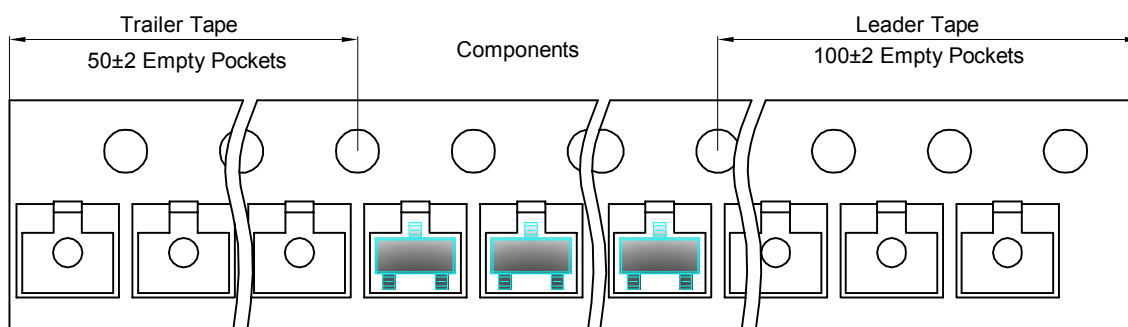

SOT-23 Reel

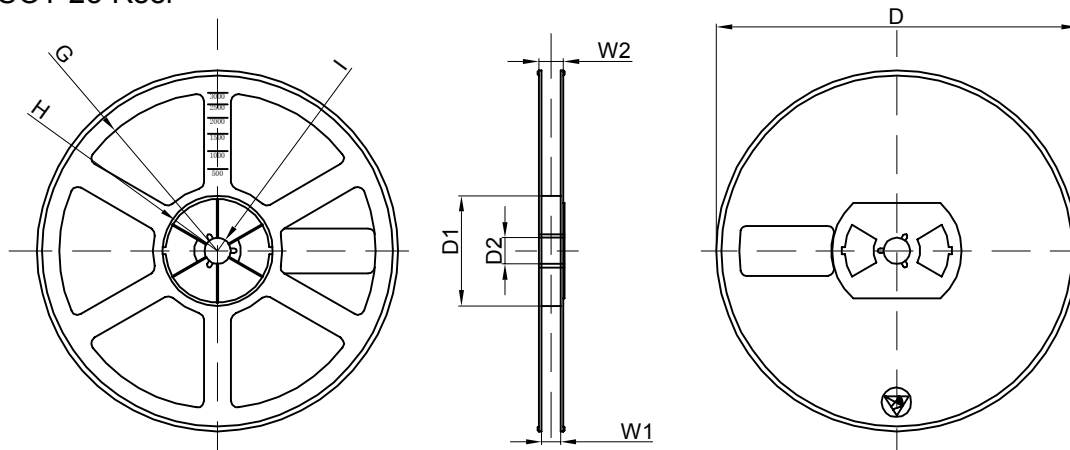

Dimensions are in millimeter								
Reel Option	D	D1	D2	G	H	I	W1	W2
7" Dia	Ø178.00	54.40	13.00	R78.00	R25.60	R6.50	9.50	12.30

REEL	Reel Size	Box	Box Size(mm)	Carton	Carton Size(mm)	G.W.(kg)
3000 pcs	7 inch	30,000 pcs	203×203×195	120,000 pcs	438×438×220	

单击下面可查看定价，库存，交付和生命周期等信息

[>>GP\(格瑞宝\)](#)