

B1020X Schottky Barrier Diode

Feature

- Extremely Fast Switch Speed
- Low Forward Voltage

MARKING:

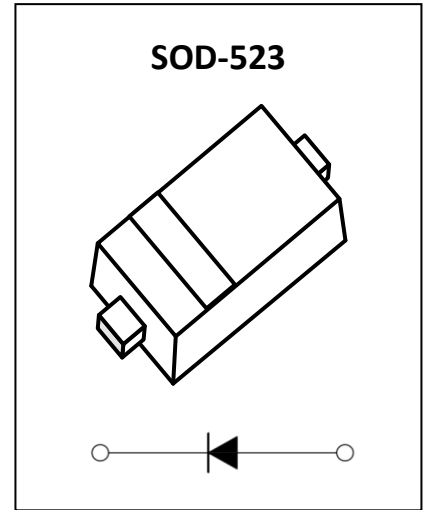

ABSOLUTE MAXIMUM RATINGS (T_a=25°C unless otherwise noted)

Parameter	Symbol	Value	Unit
DC reverse voltage	V _R	20	V
Mean rectifying current	I _O	1	A
Non-repetitive Peak Forward Surge Current @ t=8.3ms	I _{FSM}	4	A
Power Dissipation	P _D	0.15	W
Thermal Resistance from Junction to Ambient	R _{θJA}	667	°C/W
Junction Temperature	T _J	125	°C
Storage Temperature Range	T _{STG}	-55 ~ +150	°C

ELECTRICAL CHARACTERISTICS (T_a=25°C unless otherwise noted)

Parameter	Symbol	Test Condition	Min	Type	Max	Unit
Reverse breakdown voltage	V _(BR)	I _R =250μA	20			V
Forward voltage	V _{F1}	I _F =10mA			0.23	V
	V _{F2}	I _F =100mA			0.305	V
	V _{F3}	I _F =1A			0.50	V
Reverse current	I _R	V _R =10V			80	μA
		V _R =20V			100	μA
Capacitance between terminals	C _T	V _R =0V,f=1MHz			120	pF

Typical Characteristics

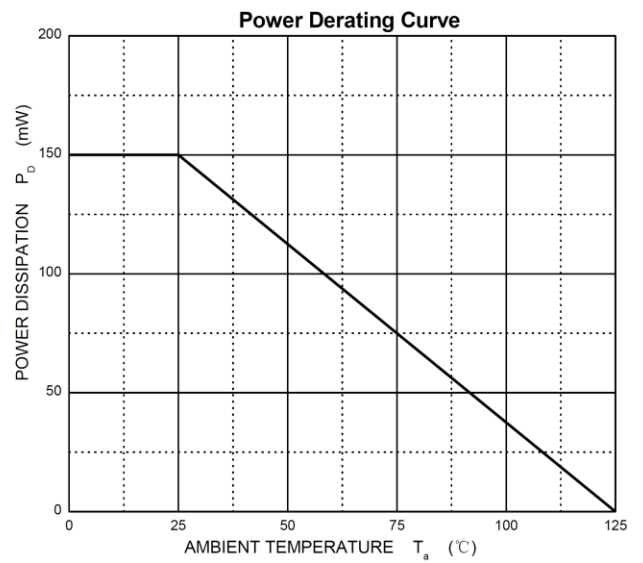
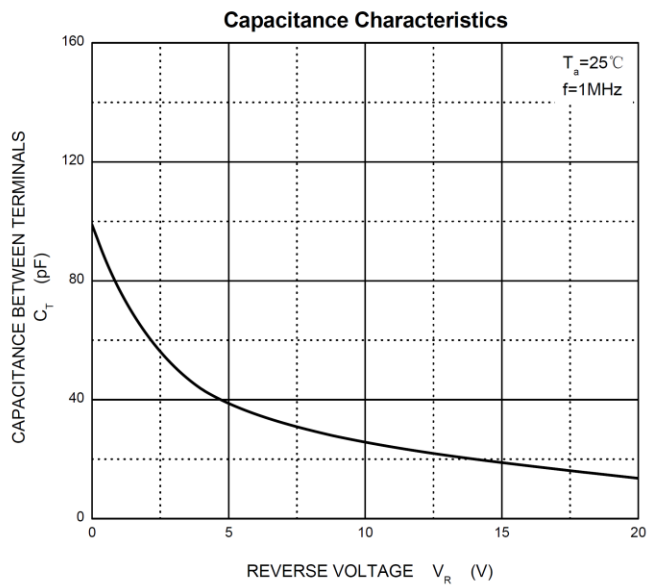
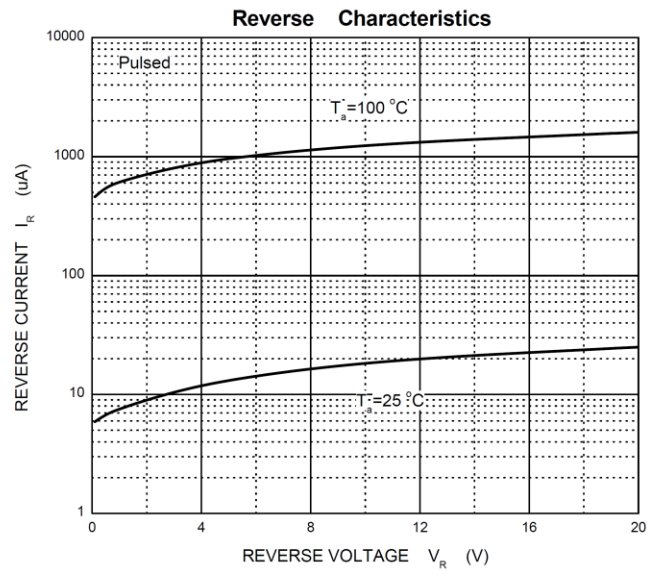
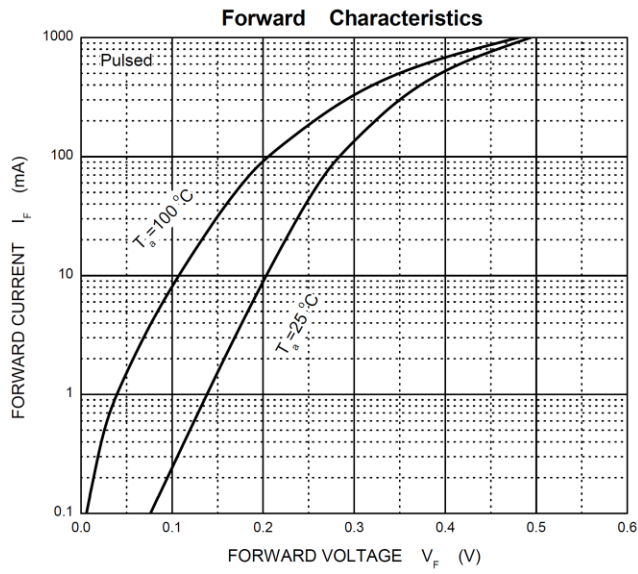

SOD-523 Package Outline Dimensions

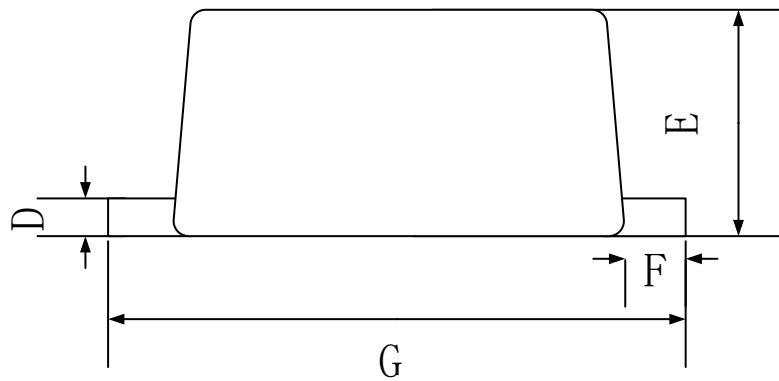
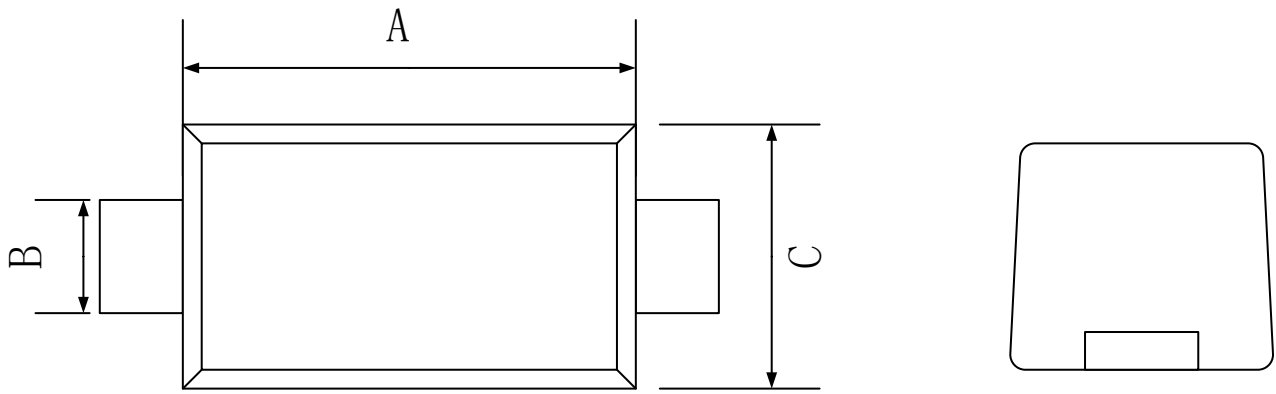

Symbol	Dimensions In Millimeters		
	Min.	Typ.	Max.
A	1.10	1.20	1.30
B	0.25	0.30	0.35
C	0.75	0.80	0.85
D	0.08	0.10	0.15
E	0.45	0.65	0.70
F	0.20 REF		
G	1.50	1.60	1.70

单击下面可查看定价，库存，交付和生命周期等信息

[>>GP\(格瑞宝\)](#)