

Product Summary

$V_{(BR)DSS}$	$R_{DS(on)TYP}$	I_D
650V	2.2Ω@10V	4A

Feature

- Low $R_{DS(on)}$
- Low FOM
- Extremely low switching loss
- Good stability and uniformity

Application

- Consumer electronics power supply
- LED Lighting
- Standby Power
- Charger

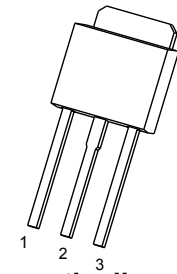
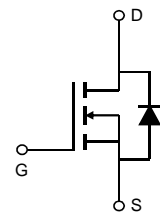
TO-251-3L

Schematic diagram

MARKING:

04N65 = Device Code
 XX = Date Code
 Solid Dot = Green Indicator

ABSOLUTE MAXIMUM RATINGS ($T_A = 25^\circ\text{C}$ unless otherwise noted)

Parameter	Symbol	Value	Unit
Drain - Source Voltage	V_{DS}	650	V
Gate - Source Voltage	V_{GS}	±30	V
Continuous Drain Current ^{1,6}	I_D	4	A
Pulsed Drain Current ²	I_{DM}	16	A
Single Pulsed Avalanche Current ³	I_{AS}	4.1	A
Single Pulsed Avalanche Energy ³	E_{AS}	252.1	mJ
Power Dissipation ^{5,6}	P_D	89	W
Thermal Resistance from Junction to Case ⁶	$R_{\theta JC}$	1.4	$^\circ\text{C/W}$
Junction Temperature	T_J	150	$^\circ\text{C}$
Storage Temperature	T_{STG}	-55~ +150	$^\circ\text{C}$

ELECTRICAL CHARACTERISTICS (T_a=25°C unless otherwise noted)

Parameter	Symbol	Test Condition	Min	Type	Max	Unit
Static Characteristics						
Drain-source breakdown voltage	V _{(BR)DSS}	V _{GS} = 0V, I _D = 250μA	650			V
Zero gate voltage drain current	I _{DSS}	V _{DS} = 650V, V _{GS} = 0V			1	μA
Gate-body leakage current	I _{GSS}	V _{GS} = ±30V, V _{DS} = 0V			±100	nA
Gate threshold voltage ^(note1)	V _{GS(th)}	V _{DS} = V _{GS} , I _D = 250μA	2.0	3.0	4.0	V
Drain-source on-resistance ^(note1)	R _{DS(on)}	V _{GS} = 10V, I _D = 2A		2.1	2.4	Ω
Forward transconductance ^(note1)	g _{rs}	V _{DS} = 50V, I _D = 1A	1			S
Dynamic characteristics^(note2)						
Input Capacitance	C _{iss}	V _{DS} = 25V, V _{GS} = 0V, f = 1MHz			565	pF
Output Capacitance	C _{oss}				135	pF
Reverse Transfer Capacitance	C _{rss}				15	pF
Total Gate Charge	Q _g	I _D = 4A, V _{DS} = 480V, V _{GS} = 10V		4	8	nC
Gate-Source Charge	Q _{gs}			2		nC
Gate-Drain Charge	Q _{gd}			1.5		nC
Turn-on delay time	t _{d(on)}	V _{GS} = 10V, V _{DS} = 300V, R _G = 9.1Ω, I _D = 4A			15	ns
Turn-on rise time	t _r				8	ns
Turn-off delay time	t _{d(off)}				30	ns
Turn-off fall time	t _f				15	ns
Source-Drain Diode characteristics						
Diode Forward voltage ^(note1)	V _{SD}	V _{GS} = 0V, I _S = 2A			1.5	V

Notes :

- 1.The maximum current rating is limited by package.
- 2.Pulse Test : Pulse Width ≤ 10μs, duty cycle ≤ 1%.
- 3.E_{AS} condition: V_{DD} = 100V, V_{GS} = 10V, L = 30mH, R_G = 25Ω Starting T_J = 25°C.
- 4.Pulse Test : Pulse Width ≤ 300μs, duty cycle ≤ 2%.
- 5.The power dissipation P_D is limited by T_{J(MAX)} = 150°C.
- 6.Device mounted on 1in² FR-4 board with 2oz. Copper, in a still air environment with T_A = 25°C.

Typical Characteristics

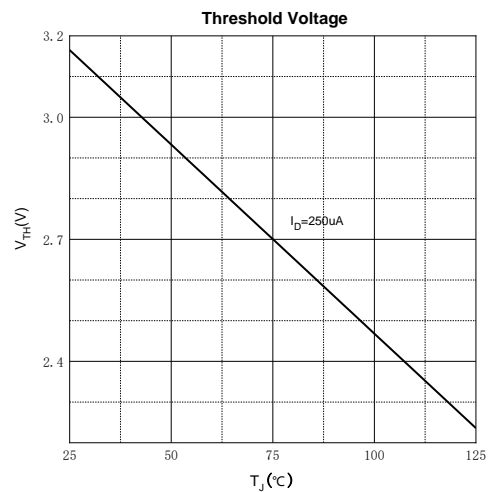
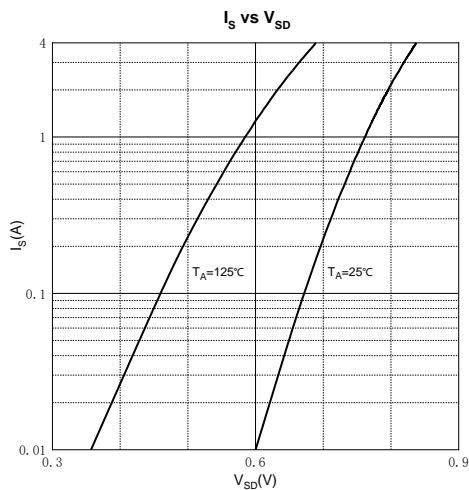
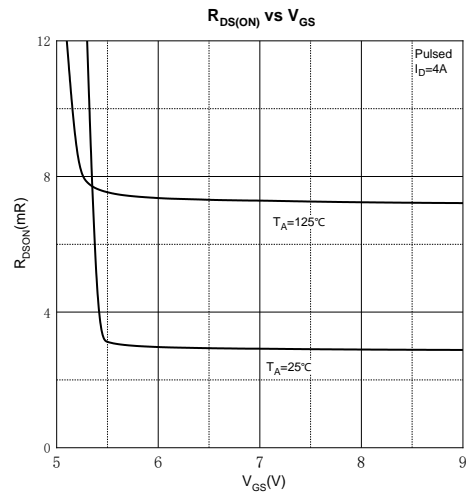
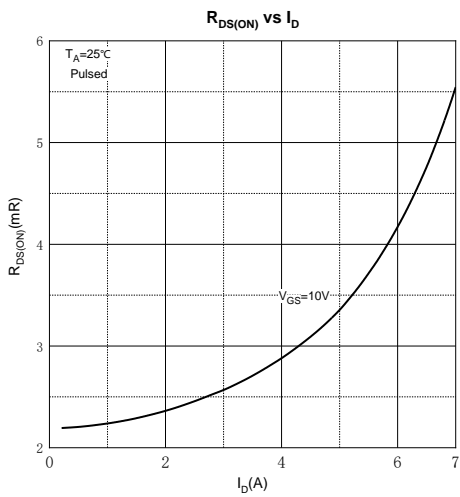
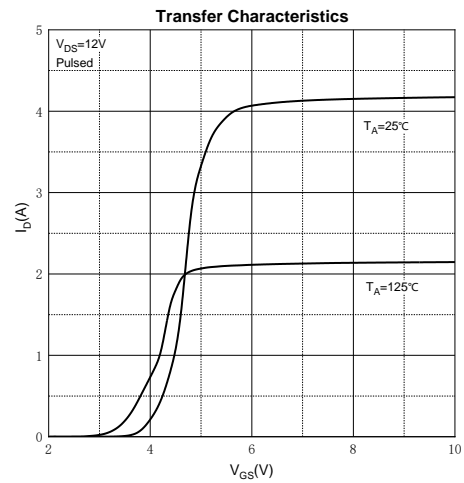
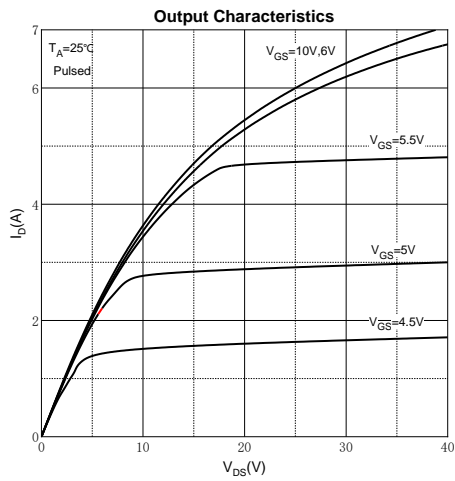

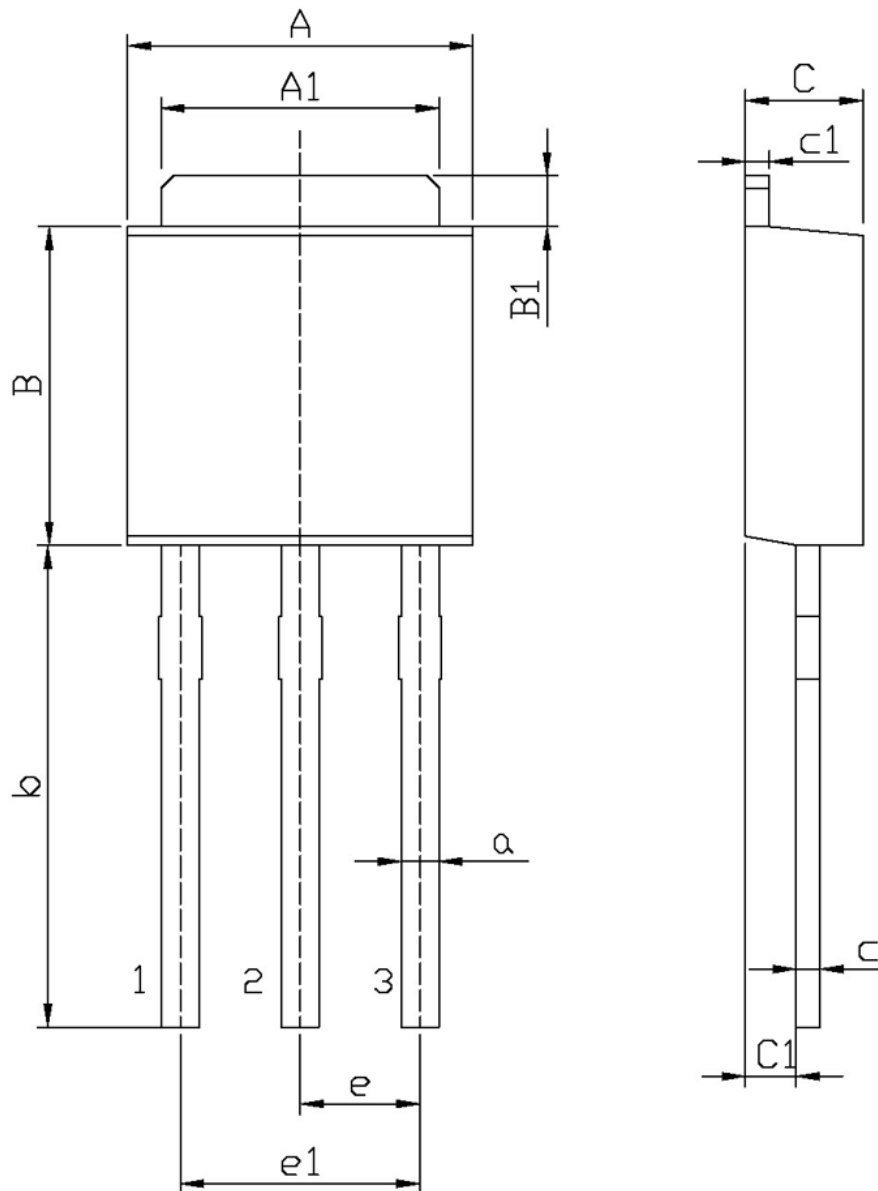
TO-251-3L Package Outline Dimensions

Symbol	Dimensions In Millimeters		Dimensions In Inches	
	Min.	Max.	Min.	Max.
A	6.450	6.750	0.254	0.266
A1	5.200	5.400	0.205	0.213
B	5.950	6.250	0.234	0.246
B1	0.950	1.250	0.037	0.049
C	2.200	2.400	0.087	0.094
C1	0.950	1.150	0.037	0.045
a	0.500	0.700	0.020	0.028
b	9.000	9.400	0.354	0.370
c	0.450	0.550	0.018	0.022
c1	0.450	0.550	0.018	0.022
e	2.240	2.340	0.088	0.092
e1	4.430	4.730	0.174	0.186

单击下面可查看定价，库存，交付和生命周期等信息

[>>GP\(格瑞宝\)](#)