



#### Product Summary

$V_{(BR)DSS}$	$R_{DS(on)TYP}$	$I_D$
-60V	60mΩ@-10V	-8A
	66mΩ@-4.5V	

#### Feature

- Trench Technology Power MOSFET
- Low  $R_{DS(ON)}$
- Low Gate Charge
- Low Gate Resistance

#### Application

- PWM Applications
- Loas Switch
- Power Management

#### MARKING:

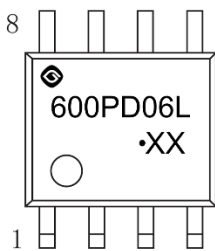

M600PD06L = Device Code  
XX = Data Code  
Solid Dot = Green Device Indicator

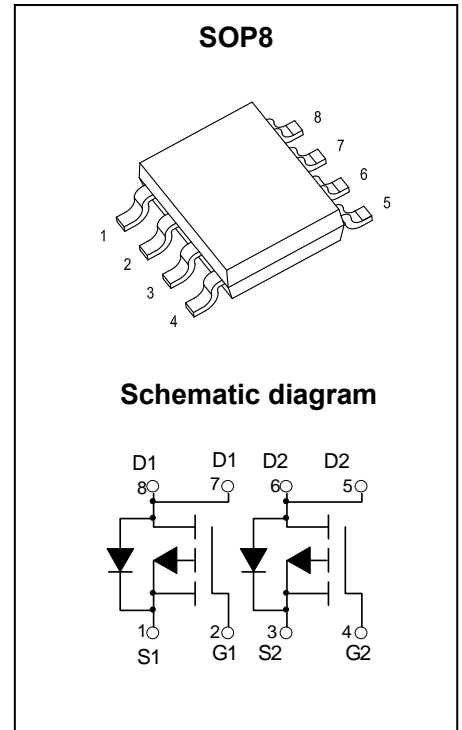

#### ABSOLUTE MAXIMUM RATINGS ( $T_A = 25^\circ\text{C}$ unless otherwise noted)

Parameter	Symbol	PMOS	Unit
Drain - Source Voltage	$V_{DS}$	-60	V
Gate - Source Voltage	$V_{GS}$	$\pm 20$	V
Continuous Drain Current <sup>1,5</sup>	$I_D$	-8	A
Pulsed Drain Current <sup>2</sup>	$I_{DM}$	-32	A
Power Dissipation <sup>4,5</sup>	$P_D$	1.6	W
Thermal Resistance from Junction to Ambient <sup>5</sup>	$R_{\theta JA}$	78	$^\circ\text{C}/\text{W}$
Junction Temperature	$T_J$	150	$^\circ\text{C}$
Storage Temperature	$T_{STG}$	-55~ +150	$^\circ\text{C}$

## MOSFET ELECTRICAL CHARACTERISTICS ( $T_J = 25^\circ\text{C}$ unless otherwise noted)

Parameter	Symbol	Test Condition	Min	Type	Max	Unit
<b>Off Characteristics</b>						
Drain - Source Breakdown Voltage	$V_{(BR)DSS}$	$V_{GS} = 0V, I_D = -250\mu A$	-60			V
Zero Gate Voltage Drain Current	$I_{DSS}$	$V_{DS} = -60V, V_{GS} = 0V$			-1	$\mu A$
Gate - Body Leakage Current	$I_{GSS}$	$V_{GS} = \pm 20V, V_{DS} = 0V$			$\pm 100$	nA
<b>On Characteristics<sup>3</sup></b>						
Gate Threshold Voltage	$V_{GS(th)}$	$V_{DS} = V_{GS}, I_D = -250\mu A$	-1	-1.9	-3	V
Drain-source On-resistance	$R_{DS(on)}$	$V_{GS} = -10V, I_D = -5A$		60	78	m $\Omega$
		$V_{GS} = -4.5V, I_D = -4A$		66	100	
<b>Dynamic Characteristics</b>						
Input Capacitance	$C_{iss}$	$V_{DS} = -30V, V_{GS} = 0V, f = 1MHz$		892		pF
Output Capacitance	$C_{oss}$			72		
Reverse Transfer Capacitance	$C_{rss}$			61		
Gate Resistance	$R_g$	$V_{DS} = 0V, V_{GS} = 0V, f = 1MHz$		2.5		$\Omega$
<b>Switching Characteristics</b>						
Total Gate Charge	$Q_g$	$V_{DS} = -30V, V_{GS} = -10V, I_D = -4A$		18		pC
Gate-source Charge	$Q_{gs}$			4		
Gate-drain Charge	$Q_{gd}$			5		
Turn-on Delay Time	$t_{d(on)}$	$V_{DD} = -30V, V_{GS} = -10V, R_L = 7.5\Omega$ $R_G = 3\Omega$		10		ns
Turn-on Rise Time	$t_r$			12		
Turn-off Delay Time	$t_{d(off)}$			24		
Turn-off Fall Time	$t_f$			10		
<b>Source - Drain Diode Characteristics</b>						
Diode Forward Voltage <sup>3</sup>	$V_{SD}$	$V_{GS} = 0V, I_S = -5A$			-1.2	V

### Notes :

- 1.The maximum current rating is limited by package.
- 2.Pulse Test : Pulse Width  $\leq 10\mu s$ , duty cycle  $\leq 1\%$ .
- 3.Pulse Test : Pulse Width  $\leq 300\mu s$ , duty cycle  $\leq 2\%$ .
- 4.The power dissipation  $P_D$  is limited by  $T_{J(MAX)} = 150^\circ\text{C}$ .
- 5.Device mounted on 1in<sup>2</sup> FR-4 board with 2oz. Copper, in a still air environment with  $T_A = 25^\circ\text{C}$ .

**Typical Characteristics**

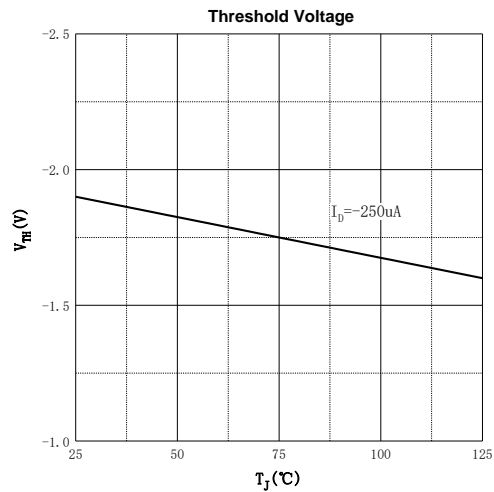
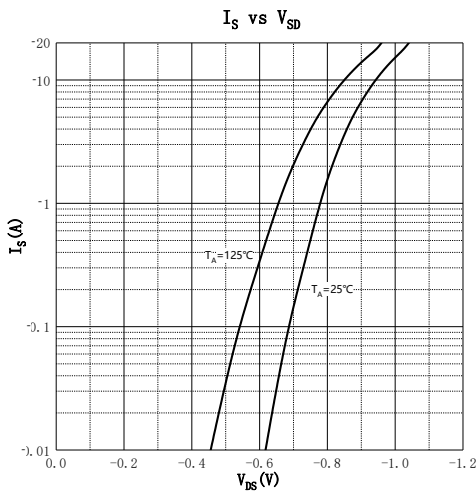
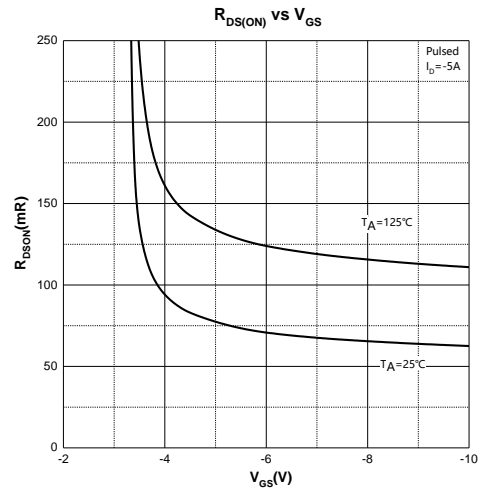
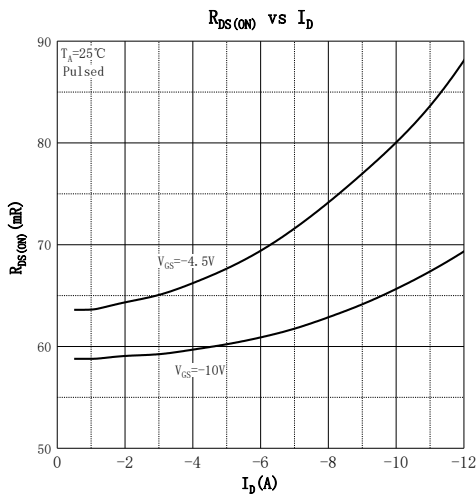
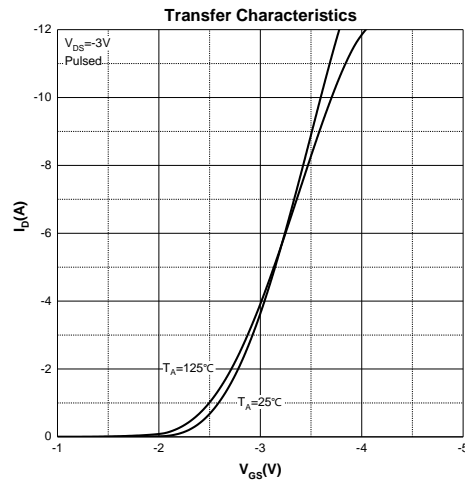
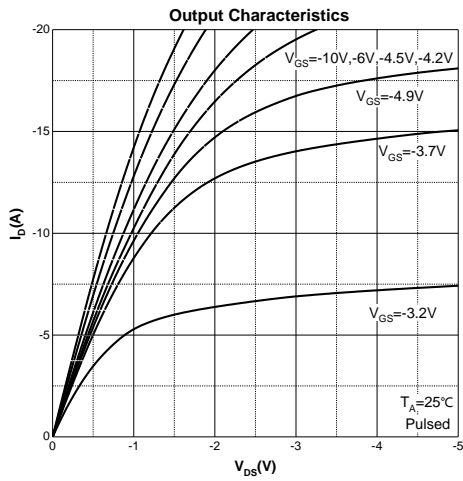

## SOP8 Package Information

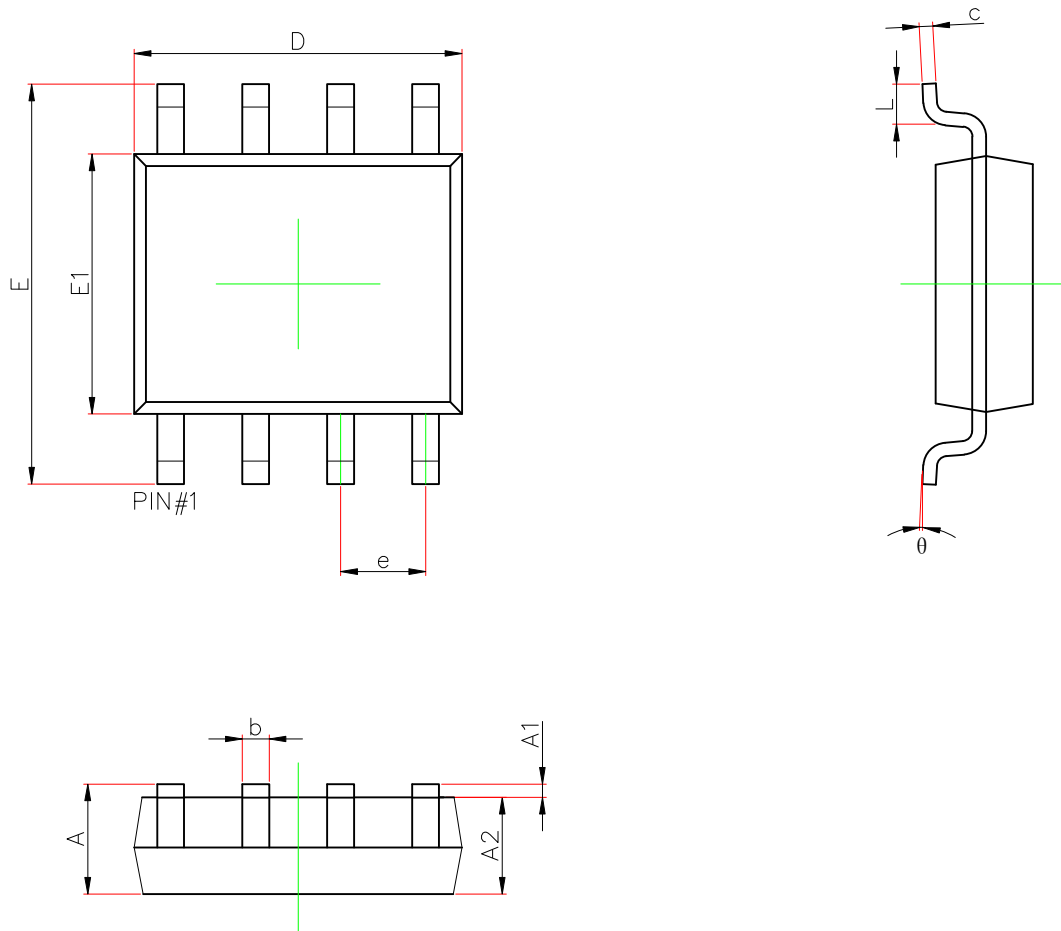

Symbol	Dimensions In Millimeters		Dimensions In Inches	
	Min.	Max.	Min.	Max.
A	1.350	1.750	0.053	0.069
A1	0.100	0.250	0.004	0.010
A2	1.350	1.550	0.053	0.061
b	0.330	0.510	0.013	0.020
c	0.156	0.250	0.006	0.010
D	4.700	5.100	0.185	0.201
e	1.270(BSC)		0.050(BSC)	
E	5.800	6.200	0.228	0.244
E1	3.700	4.100	0.146	0.161
L	0.400	1.270	0.016	0.05
$\theta$	0°	8°	0°	8°

单击下面可查看定价，库存，交付和生命周期等信息

[>>GP\(格瑞宝\)](#)