

Product Summary

$V_{(BR)DSS}$	$R_{DS(on)TYP}$	I_D
30V	34mΩ@10V	4A
	37mΩ@4.5V	
	45mΩ@2.5V	

Feature

- TrenchFET Power MOSFET
- Excellent $R_{DS(on)}$ and Low Gate Charge

Application

- DC/DC Converter
- Load Switch for Portable Devices
- Battery Switch

MARKING:

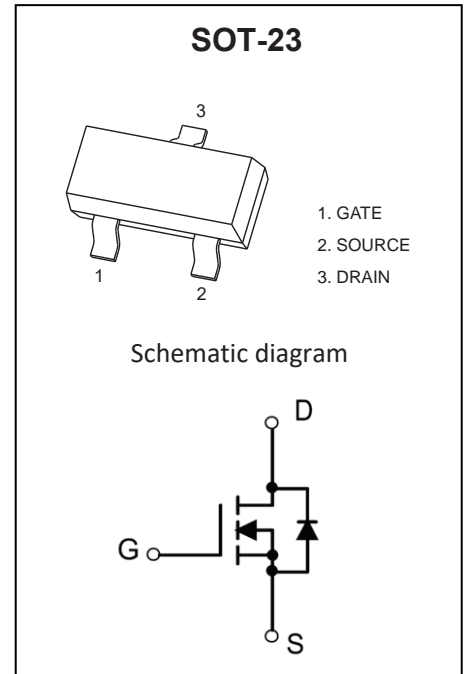
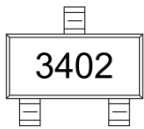

ABSOLUTE MAXIMUM RATINGS ($T_a=25^{\circ}C$ unless otherwise noted)

Parameter	Symbol	Value	Unit
Drain-Source Voltage	V_{DS}	30	V
Gate-Source Voltage	V_{GS}	±12	V
Continuous Drain Current	I_D	4	A
Pulsed Drain Current ⁽¹⁾	I_{DM}	15	A
Power Dissipation	P_D	1.5	W
Thermal Resistance from Junction to Ambient ⁽²⁾	$R_{\theta JA}$	83.3	$^{\circ}C/W$
Junction Temperature	T_J	150	$^{\circ}C$
Storage Temperature	T_{STG}	-55~ +150	$^{\circ}C$

MOSFET ELECTRICAL CHARACTERISTICS(T_a=25°C unless otherwise noted)

Parameter	Symbol	Test Condition	Min	Type	Max	Unit
STATIC CHARACTERISTICS						
Drain-source breakdown voltage	V _{(BR)DSS}	V _{GS} = 0V, I _D =250μA	30			V
Zero gate voltage drain current	I _{DSS}	V _{DS} =30V, V _{GS} = 0V			1	μA
Gate-body leakage current	I _{GSS}	V _{GS} =±12V, V _{DS} = 0V			±100	nA
Gate threshold voltage ⁽³⁾	V _{GS(th)}	V _{DS} =V _{GS} , I _D =250μA	0.5	0.95	1.5	V
Drain-source on-resistance ⁽³⁾	R _{DS(on)}	V _{GS} =10V, I _D =4A		34	52	mΩ
		V _{GS} =4.5V, I _D =3A		37	65	
		V _{GS} =2.5V, I _D =2A		45	85	
Forward tranconductance ⁽³⁾	g _{FS}	V _{DS} =5V, I _D =3.6A		13		S
DYNAMIC CHARACTERISTICS⁽⁴⁾						
Input Capacitance	C _{iss}	V _{DS} =15V, V _{GS} =0V, f=1MHz		389		pF
Output Capacitance	C _{oss}			54		
Reverse Transfer Capacitance	C _{rss}			40		
Gate resistance	R _g	V _{DS} =0V, V _{GS} =0V, f =1MHz		3.5		Ω
SWITCHING CHARACTERISTICS⁽⁴⁾						
Turn-on delay time	t _{d(on)}	V _{GS} =10V, V _{DS} =15V, R _L =3.75Ω, R _{GEN} =6Ω		3.5		ns
Turn-on rise time	t _r			1.2		
Turn-off delay time	t _{d(off)}			22		
Turn-off fall time	t _f			2.2		
Total gate charge	Q _g	V _{DS} =15V, V _{GS} =4.5V, I _D =4A		4.4		nC
Gate-source charge	Q _{gs}			0.7		
Gate-drain charge	Q _{gd}			1.3		
SOURCE-DRAIN DIODE CHARACTERISTICS						
Body Diode Voltage ⁽³⁾	V _{SD}	I _S =1A, V _{GS} = 0V			1	V
Continuous Source-Drain Diode Current	I _S	T _C =25°C			1.5	A
Body diode reverse recovery time	t _r	I _F =4A, dI/dt=100A/μs		1.3		ns
Body diode reverse recovery charge	Q _{rr}				6.2	

Notes:

1. Repetitive rating : Pulse width limited by junction temperature.
2. Surface mounted on FR4 board , t_s≤10s.
3. Pulse Test : Pulse Width≤80μs, Duty Cycle≤0.5%.
4. Guaranteed by design, not subject to producing.

Typical Electrical and Thermal Characteristics

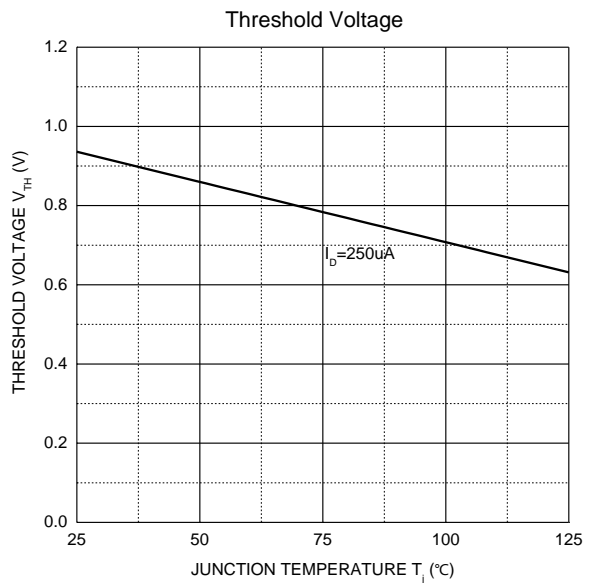
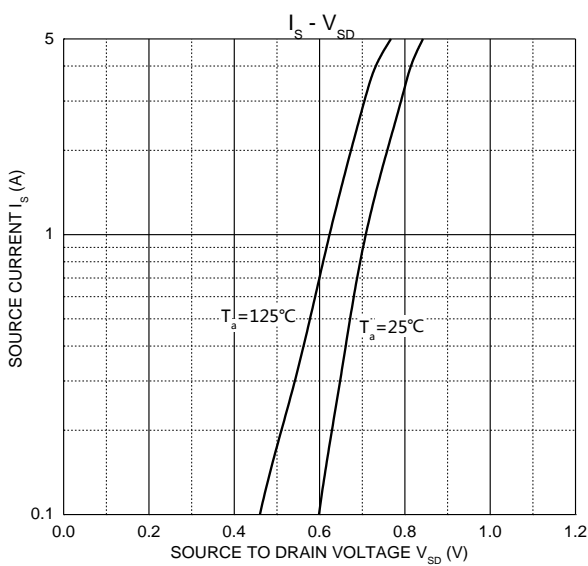
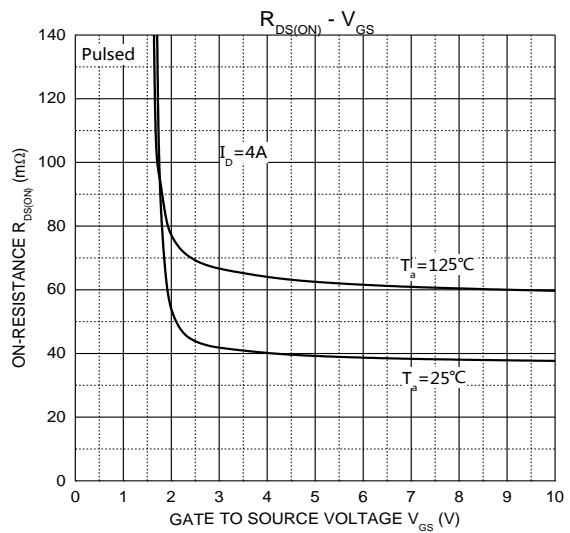
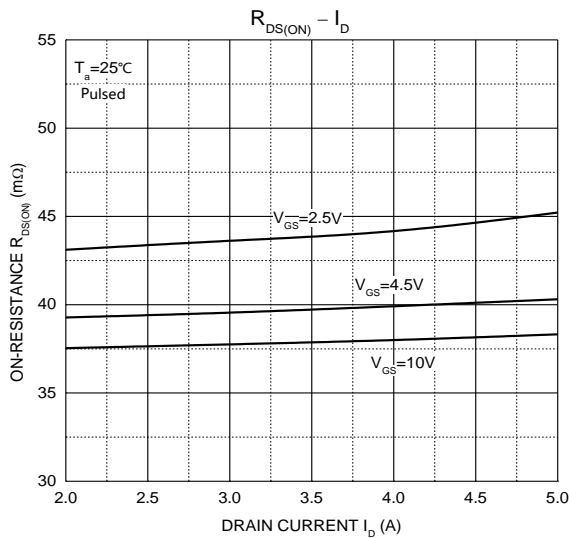
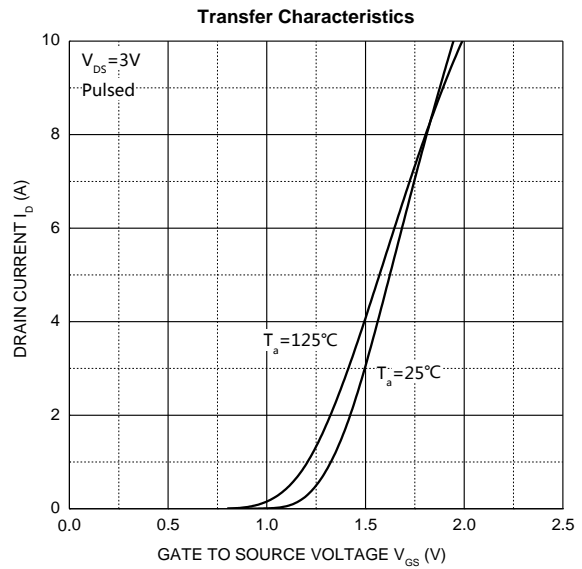
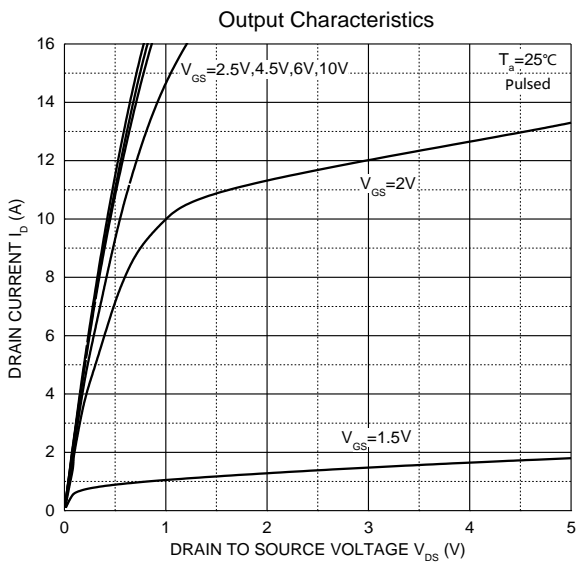

SOT-23 Package Information

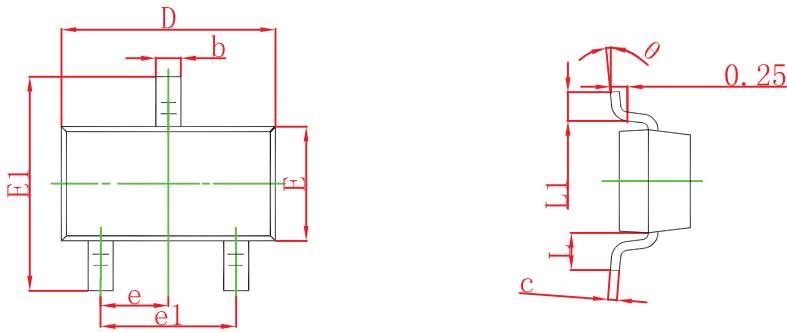

Symbol	Dimensions In Millimeters		Dimensions In Inches	
	Min	Max	Min	Max
A	0.900	1.150	0.035	0.045
A1	0.000	0.100	0.000	0.004
A2	0.900	1.050	0.035	0.041
b	0.300	0.500	0.012	0.020
c	0.080	0.150	0.003	0.006
D	2.800	3.000	0.110	0.118
E	1.200	1.400	0.047	0.055
E1	2.250	2.550	0.089	0.100
e	0.950 TYP		0.037 TYP	
e1	1.800	2.000	0.071	0.079
L	0.550 REF		0.022 REF	
L1	0.300	0.500	0.012	0.020
θ	0°	8°	0°	8°

SOT-23 Tape and Reel

SOT-23 Tape and reel

SOT-23 Embossed Carrier Tape

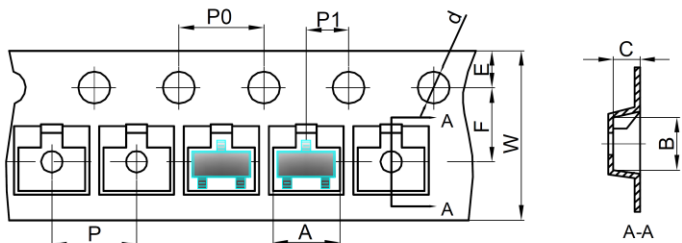

Dimensions are in millimeter										
Pkg type	A	B	C	d	E	F	P0	P	P1	W
SOT-23	3.15	2.77	1.22	Ø1.50	1.75	3.50	4.00	4.00	2.00	8.00

SOT-23 Tape Leader and Trailer

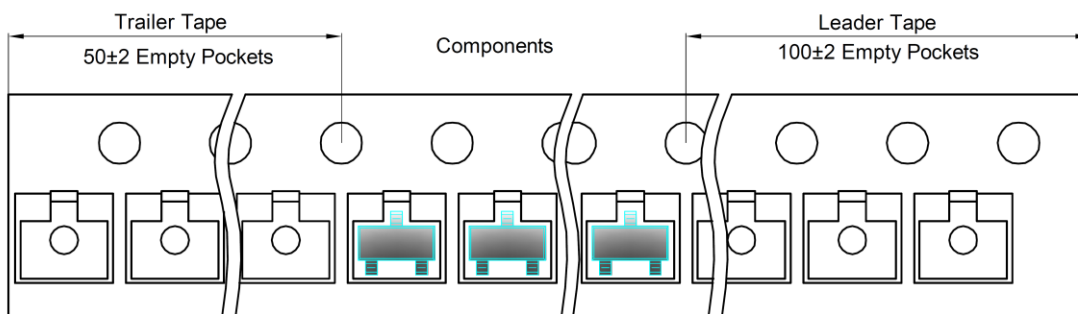

SOT-23 Reel

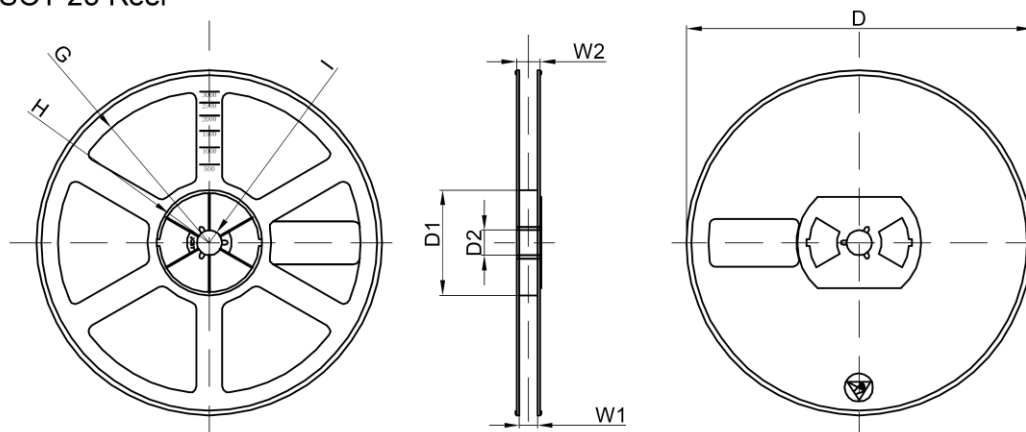

Dimensions are in millimeter								
Reel Option	D	D1	D2	G	H	I	W1	W2
7" Dia	Ø178.00	54.40	13.00	R78.00	R25.60	R6.50	9.50	12.30

REEL	Reel Size	Box	Box Size(mm)	Carton	Carton Size(mm)	G.W.(kg)
3000 pcs	7 inch	30,000 pcs	203×203×195	120,000 pcs	438×438×220	

单击下面可查看定价，库存，交付和生命周期等信息

[>>GP\(格瑞宝\)](#)