

Product Summary

The GESDBK3V3Y1N is designed to protect voltage sensitive electronic components from ESD and other transients. Excellent clamping capability, low leakage, low capacitance, and fast response time, make these parts ideal for ESD protection on designs where board space is at a premium. Because of its small size, it is suited for use in digital cameras, cellular phones, MP3 players and many other portable applications where board space is at a premium.

Feature

- Low reverse stand-off voltage: 3.3V Max.
- Low reverse clamping voltage
- Ultra-low leakage current
- Fast response time
- IEC 61000-4-2 Level 4 ESD protection

Application

- Digital cameras
- Portable applications
- Audio and video equipment
- MP3 players
- Mobile phone

Marking:



Front Side

LA=Device Code

DFN1006-2L

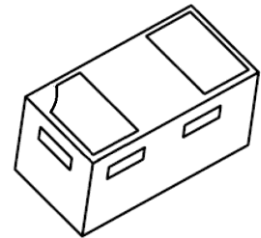

Schematic diagram

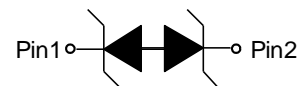

Absolute Maximum Ratings (Ta=25°C unless otherwise noted)

Parameter	Symbol	Value	Unit
IEC 61000-4-2 ESD Voltage Air Model	V _{ESD}	±30	kV
IEC 61000-4-2 ESD Voltage Contact Model		±30	
JESD22-A114-B ESD Voltage Per Human Body Model		±16	
ESD Voltage Machine Model		±0.4	
Peak Pulse Power (8/20μs)	P _{pk}	90	W
Peak Pulse Current (8/20μs)	I _{PP}	9	A
Junction Temperature	T _J	-55~ +125	°C
Storage Temperature	T _{stg}	-55~ +150	°C

ESD standards compliance

IEC61000-4-2 Standard

Contact Discharge		Air Discharge	
Level	Test Voltage kV	Level	Test Voltage kV
1	2	1	2
2	4	2	4
3	6	3	8
4	8	4	15

JESD22-A114-B Standard

ESD Class	Human Body Discharge V
0	0~249
1A	250~499
1B	500~999
1C	1000~1999
2	2000~3999
3A	4000~7999
3B	8000~15999

Contact discharge current waveform per IEC61000-4-2

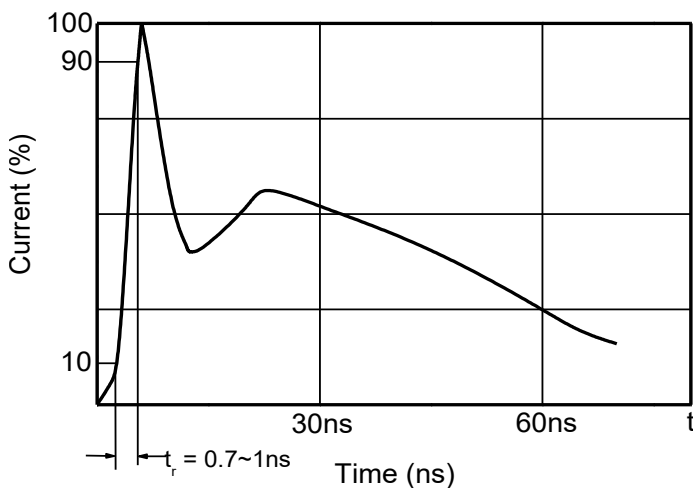

8/20μs waveform per IEC61000-4-5

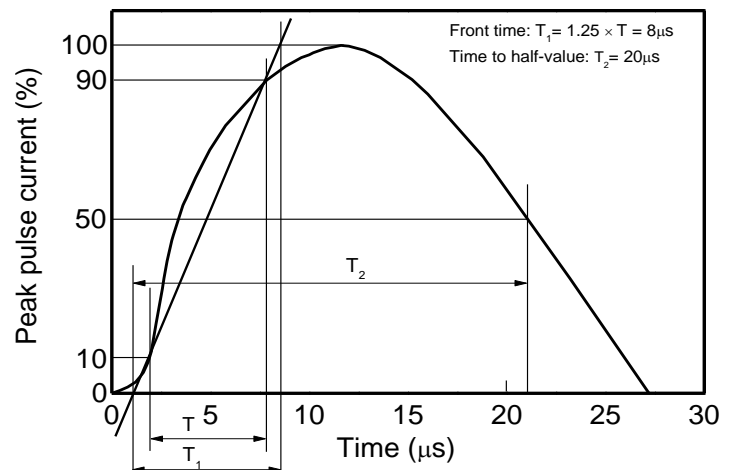

Electrical Parameter

Symbol	Parameter
V _C	Clamping Voltage @ I _{PP}
I _{PP}	Peak Pulse Current
V _{BR}	Breakdown Voltage @ I _{BR}
I _{BR}	Test Current
I _R	Reverse Leakage Current @ V _{RWM}
V _{RWM}	Reverse Standoff Voltage

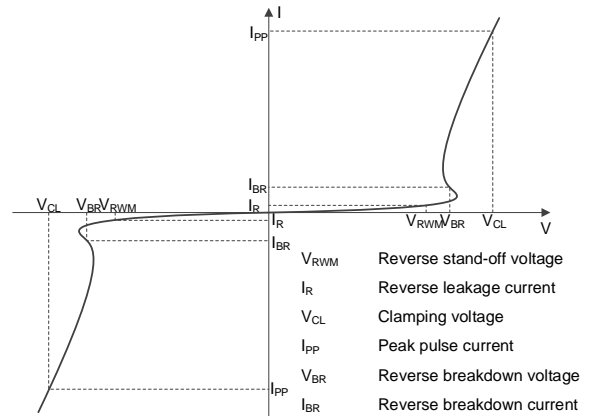

V-I characteristics for a Bi-directional TVS

Electrical Characteristics (Ta=25°C unless otherwise specified)

Parameter	Symbol	Test conditions	Min	Typ	Max	Unit
Reverse stand-off voltage	V _{RWM}				3.3	V
Reverse leakage current	I _R	V _{RWM} =3.3V			0.1	μA
Breakdown voltage	V _{BR}	I _T =1mA	3.4		4.8	V
Clamping voltage	V _{C1}	I _{PP} = 1A (8 x 20μs pulse)		5.0	6	V
	V _{C2}	I _{PP} = 9A (8 x 20μs pulse)		8.5	10	V
Junction capacitance	C _J	V _R =0V, f=1MHz		12		pF

Typical Characteristics

V_C vs. I_{PP}

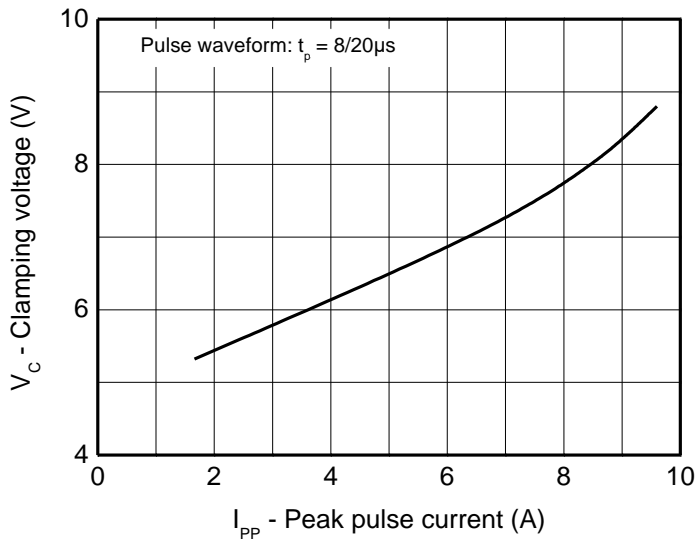

I-V Curve

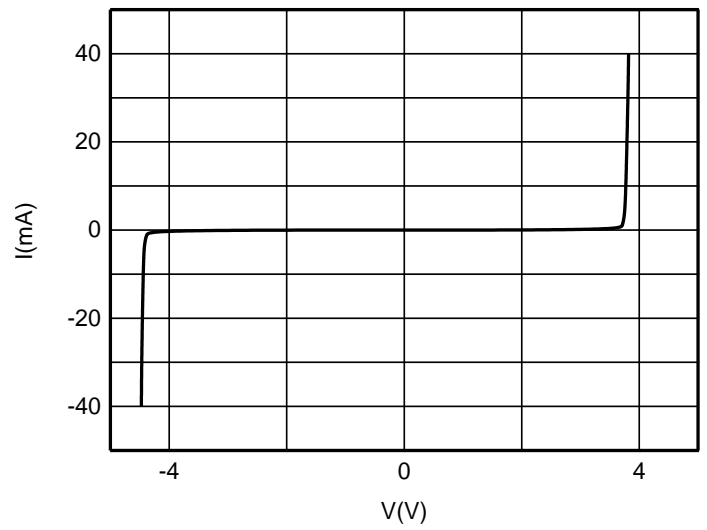

Peak pulse power vs. Pulse time

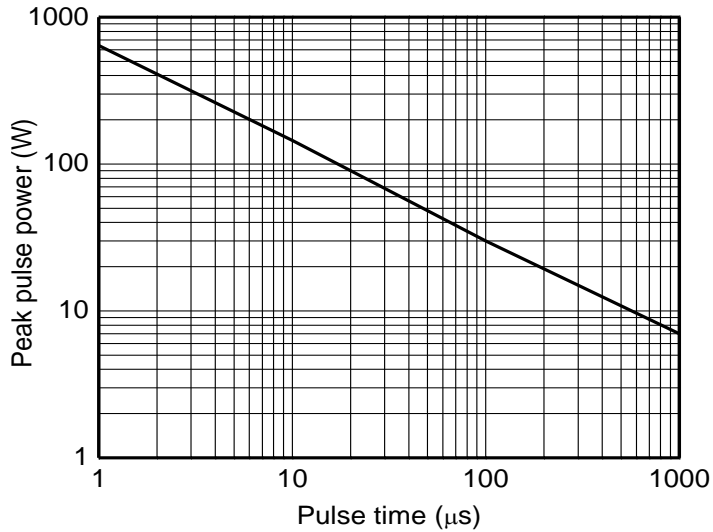

Power derating vs. Ambient temperature

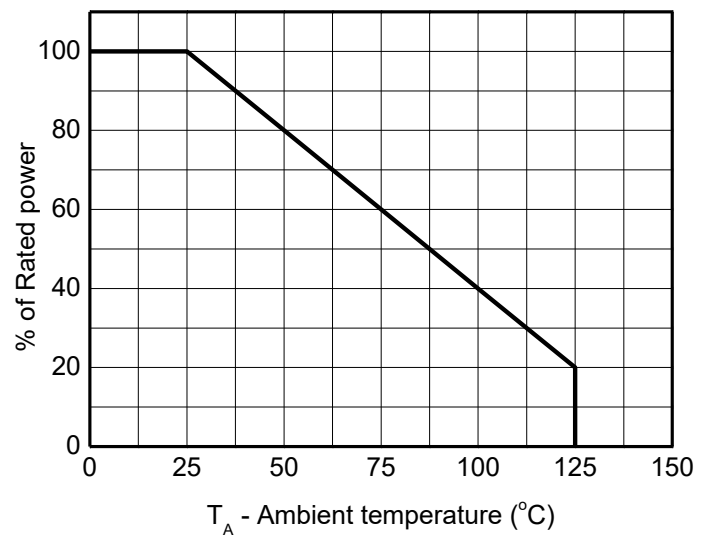

DFN0603-2L Package Outline Dimensions

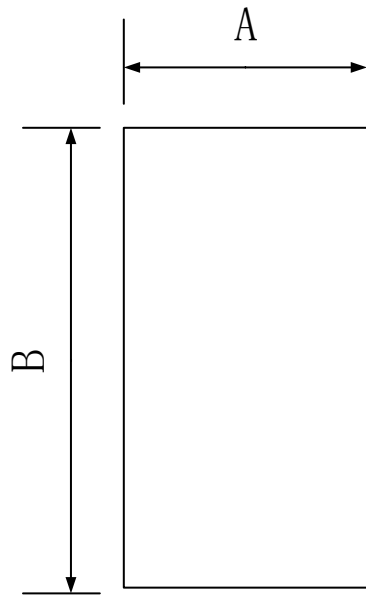

Top View

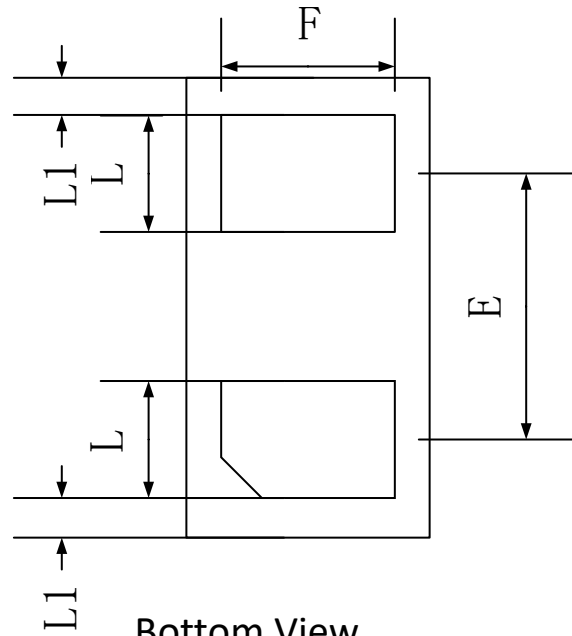

Bottom View

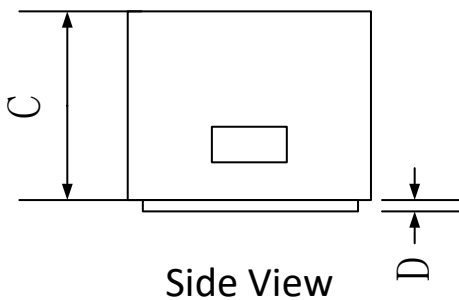

Side View

	Dimensions In Millimeters		
	Min.	Typ.	Max.
A	0.55	0.60	0.68
B	0.95	1.00	1.08
C	0.44	0.47	0.50
D	0.00	0.03	0.05
E	-	0.65	-
F	0.40	0.50	0.60
L	0.20	0.25	0.30
L1	0.05REF		

DFN1006-2L Tape and Reel

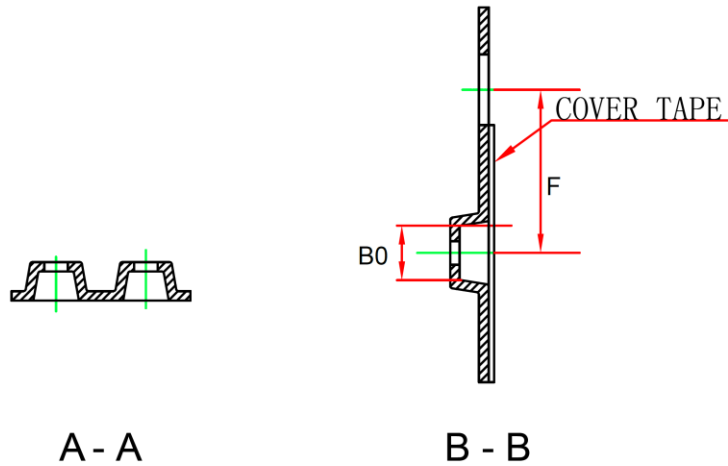
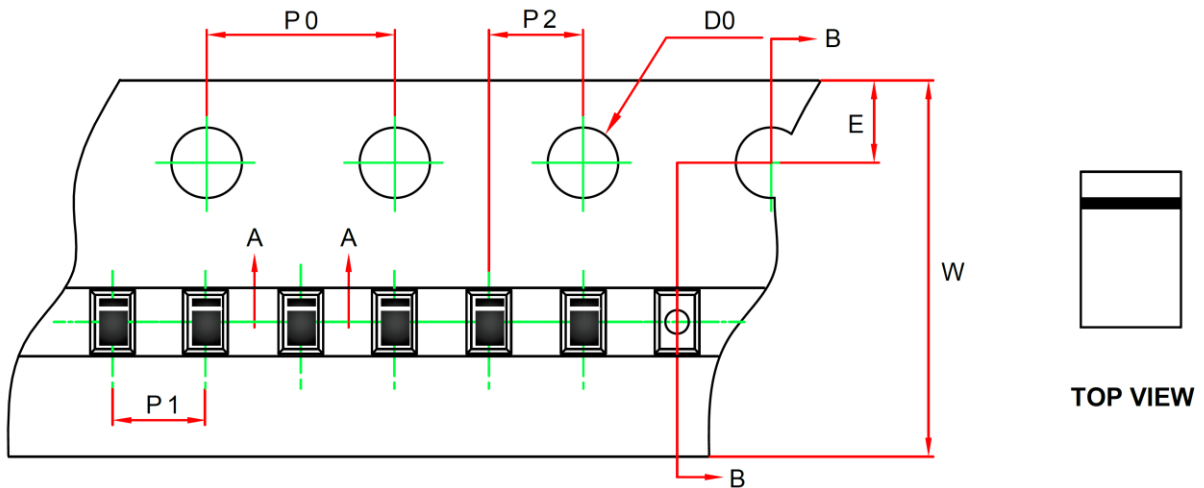

Dimensions In Millimeters (mm)								
Pkg type	B0	P0	P1	P2	E	F	W	D0
DFN1.0×0.6-2L	1.11	4.00	2.00	2.00	1.75	3.50	8.00	1.55
Tolerance	+/-0.06	+/-0.1	+/-0.1	+/-0.1	+/-0.1	+/-0.1	+/-0.3	+/-0.15

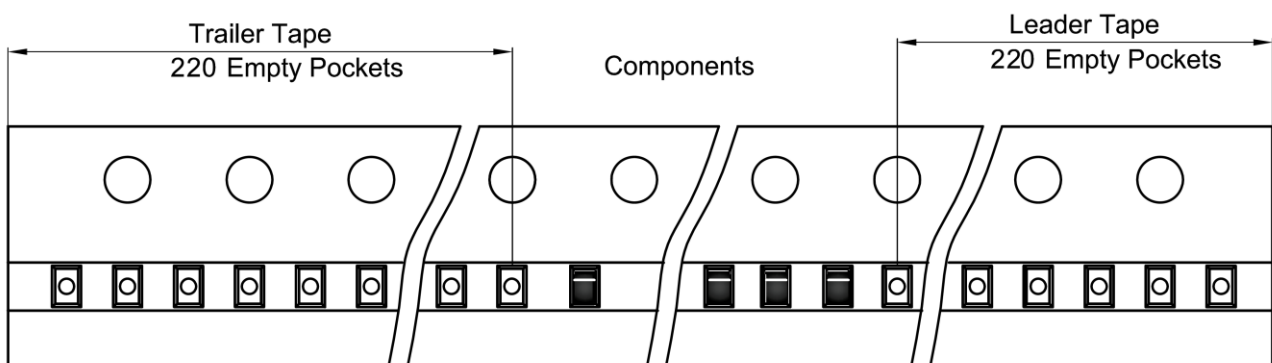

单击下面可查看定价，库存，交付和生命周期等信息

[>>GP\(格瑞宝\)](#)