

Product Summary

The GESDBU2V5Y1 is designed to protect voltage sensitive electronic components from ESD and other transients. Excellent clamping capability, low leakage, low capacitance, and fast response time provide best in class protection on designs that are exposed to ESD.

The combination of small size, low capacitance, and high level of ESD protection makes them a flexible solution for applications such as HDMI, Display Port TM, and MDDI interfaces. It is designed to replace multiplayer varistors (MLV) in consumer equipment applications such as mobile phone, notebook, PAD, STB, LCD TV etc.

Feature

- Low reverse stand-off voltage: 2.5V Max.
- Low reverse clamping voltage
- Low leakage current
- Fast response time
- IEC 61000-4-2 Level 4 ESD protection

Application

- Digital cameras
- Portable applications
- Audio and video equipment
- MP3 players
- Mobile phone

Marking:

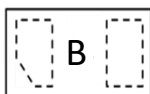

Front Side
B=Device Code

DFN1006-2L

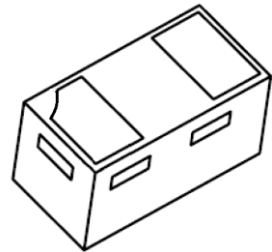

Schematic diagram

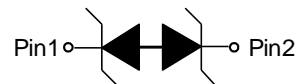

Absolute Maximum Ratings ($T_a=25^{\circ}\text{C}$ unless otherwise noted)

Parameter	Symbol	Value	Unit
Peak Pulse Power ($t_p = 8/20\mu\text{s}$)	P_{pk}	30	W
Peak Pulse Current ($t_p = 8/20\mu\text{s}$)	I_{PP}	4	A
IEC 61000-4-2 ESD Voltage	Air Model	± 15	kV
IEC 61000-4-2 ESD Voltage	Contact Model	± 15	
JESD22-A114-B ESD Voltage	Per Human Body Model	± 16	
ESD Voltage	Machine Model	± 0.4	
Lead Solder Temperature – Maximum (10 Second Duration)	T_L	260	$^{\circ}\text{C}$
Junction Temperature	T_j	150	$^{\circ}\text{C}$
Storage Temperature	T_{stg}	-55~ +150	$^{\circ}\text{C}$

ESD standards compliance

IEC61000-4-2 Standard

Contact Discharge		Air Discharge	
Level	Test Voltage kV	Level	Test Voltage kV
1	2	1	2
2	4	2	4
3	6	3	8
4	8	4	15

JESD22-A114-B Standard

ESD Class	Human Body Discharge V
0	0~249
1A	250~499
1B	500~999
1C	1000~1999
2	2000~3999
3A	4000~7999
3B	8000~15999

Contact discharge current waveform per IEC61000-4-2

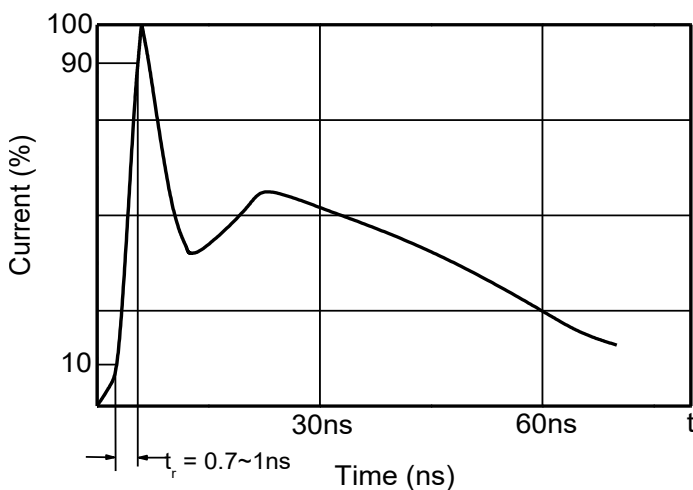

8/20 μs waveform per IEC61000-4-5

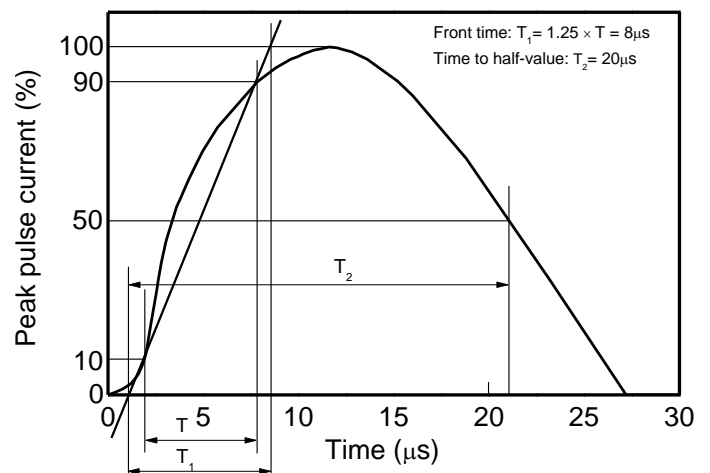

Electrical Parameter

Symbol	Parameter
V _C	Clamping Voltage @ I _{PP}
I _{PP}	Peak Pulse Current
V _{BR}	Breakdown Voltage @ I _{BR}
I _{BR}	Test Current
I _R	Reverse Leakage Current @ V _{RWM}
V _{RWM}	Reverse Standoff Voltage

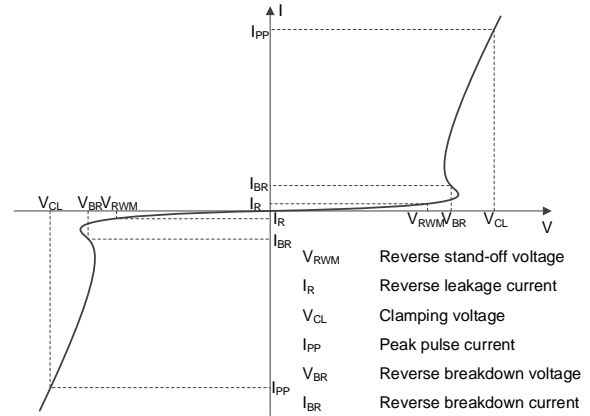

V-I characteristics for a Bi-directional TVS

Electrical Characteristics (T_a=25°C unless otherwise specified)

Parameter	Symbol	Test conditions	Min	Typ	Max	Unit
Reverse standoff voltage	V _{RWM} ¹⁾				2.5	V
Reverse leakage current	I _R	V _{RWM} =2.5V			0.1	μA
Breakdown voltage	V _{BR}	I _T =1mA	6	11	13	V
Clamping voltage	V _{C1} ²⁾	I _{PP} =4A		6	7.5	V
Junction capacitance	C _J	V _R =0V, f=1MHz		0.4		pF

- 1) Other voltages available upon request.
- 2) Non-repetitive current pulse 8/20μs exponential decay waveform according to IEC61000-4-5

Typical Characteristics

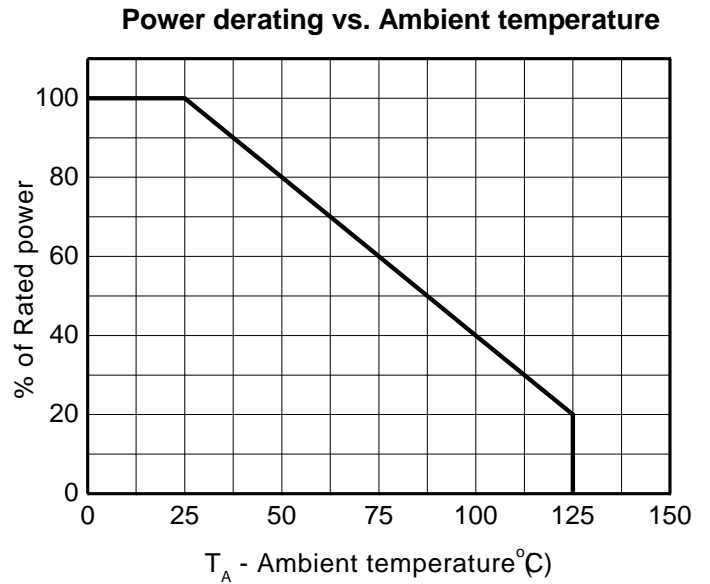
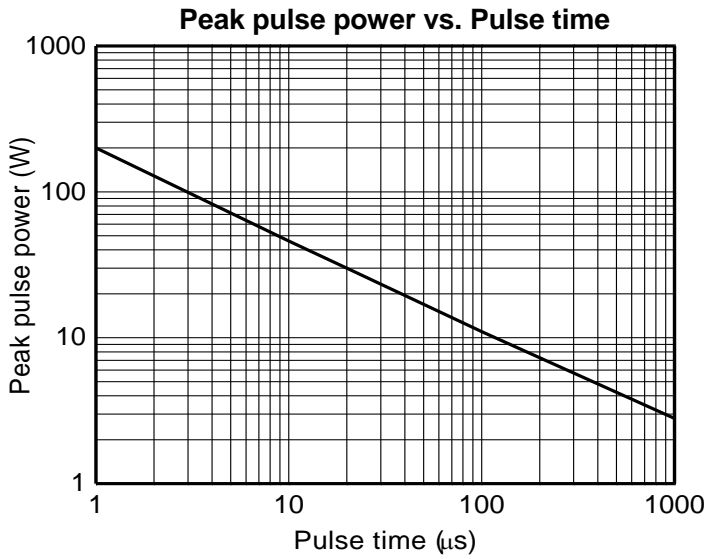
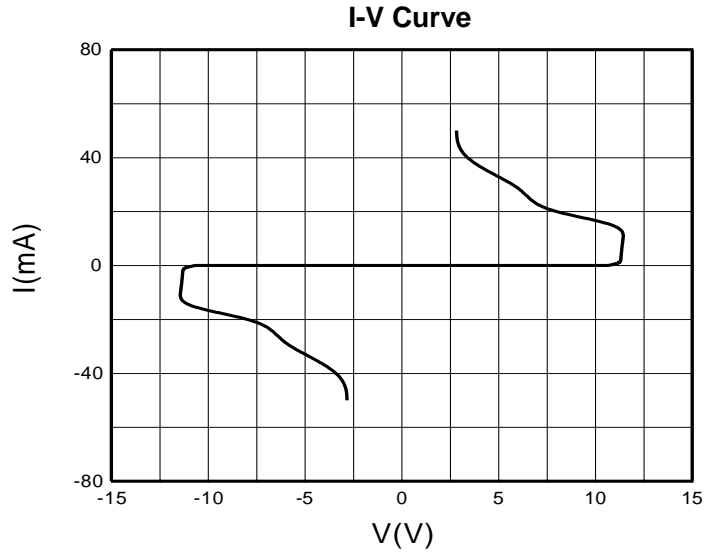
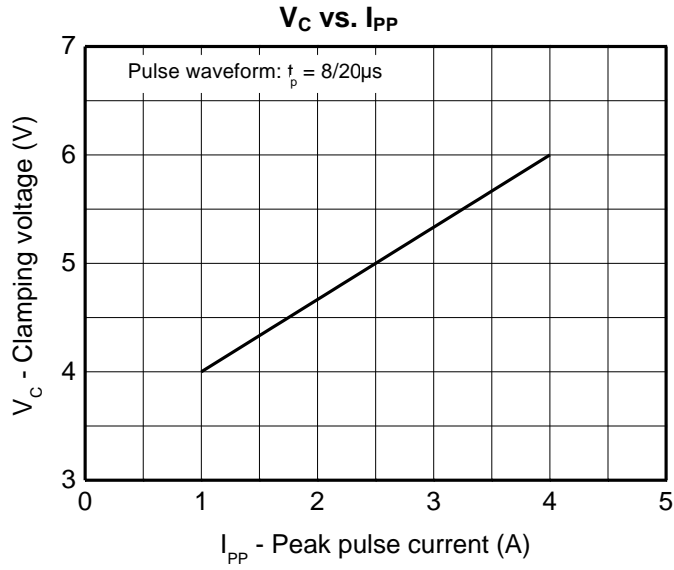

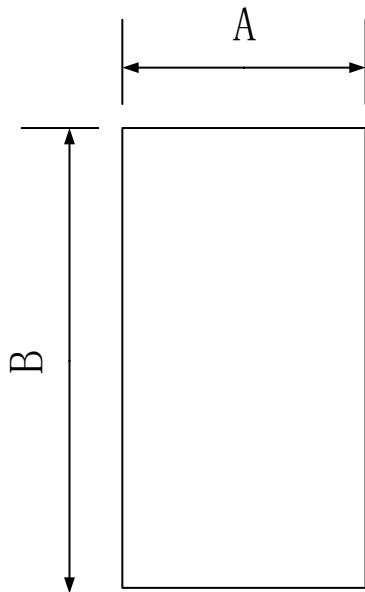
DFN1006-2L Package Outline Dimensions

Top View

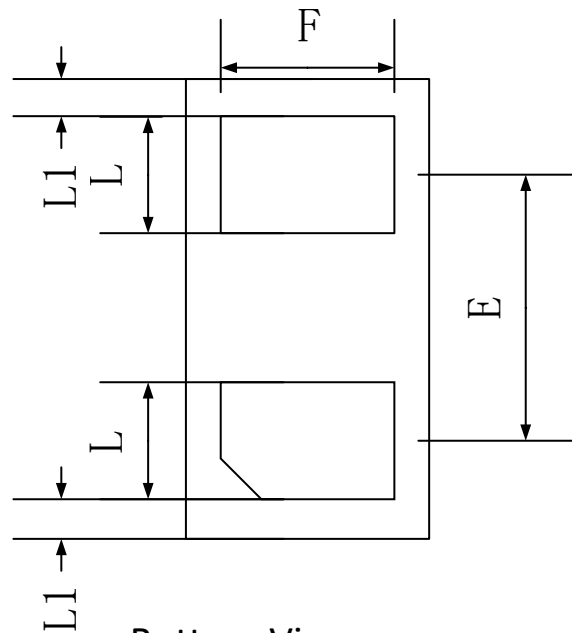

Bottom View

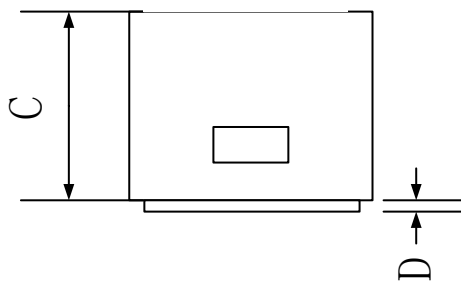

Side View

	Dimensions In Millimeters		
	Min.	Typ.	Max.
A	0.55	0.60	0.68
B	0.95	1.00	1.08
C	0.44	0.47	0.50
D	0.00	0.03	0.05
E	-	0.65	-
F	0.40	0.50	0.60
L	0.20	0.25	0.30
L1	0.05REF		

DFN1006-2L Tape and Reel

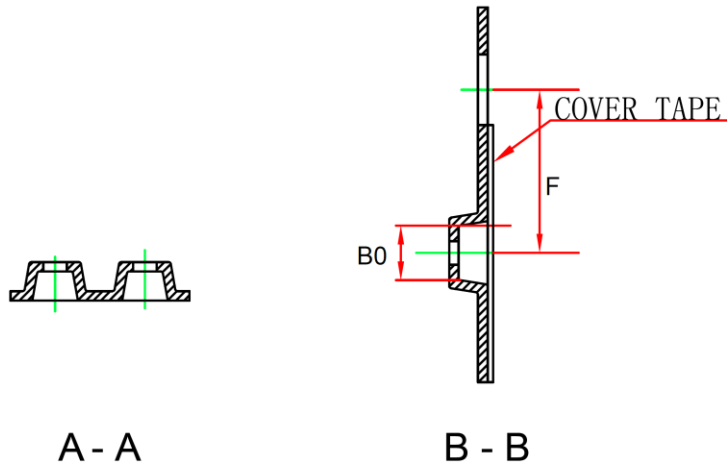
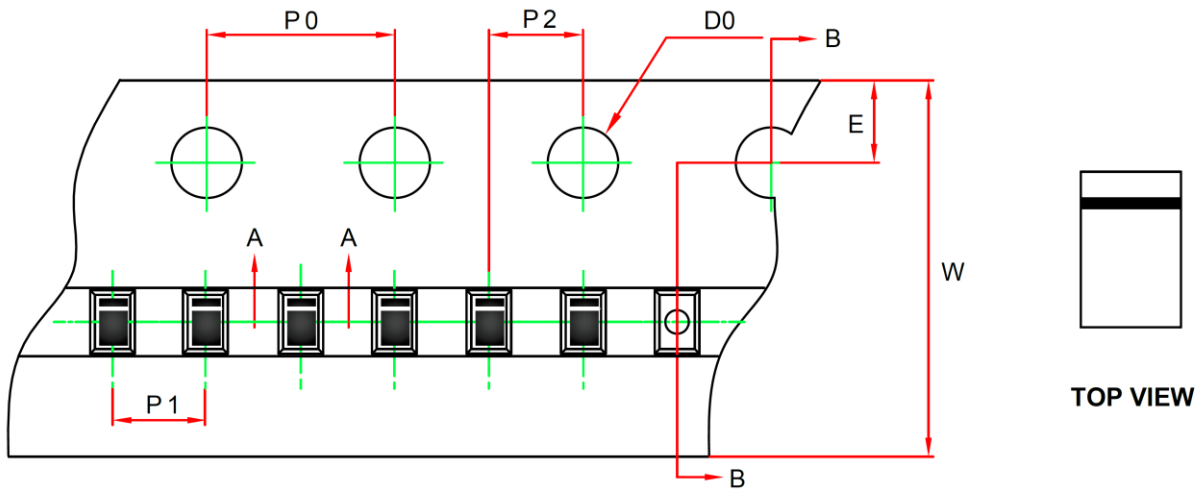

Dimensions In Millimeters (mm)								
Pkg type	B0	P0	P1	P2	E	F	W	D0
DFN1.0×0.6-2L	1.11	4.00	2.00	2.00	1.75	3.50	8.00	1.55
Tolerance	+/-0.06	+/-0.1	+/-0.1	+/-0.1	+/-0.1	+/-0.1	+/-0.3	+/-0.15

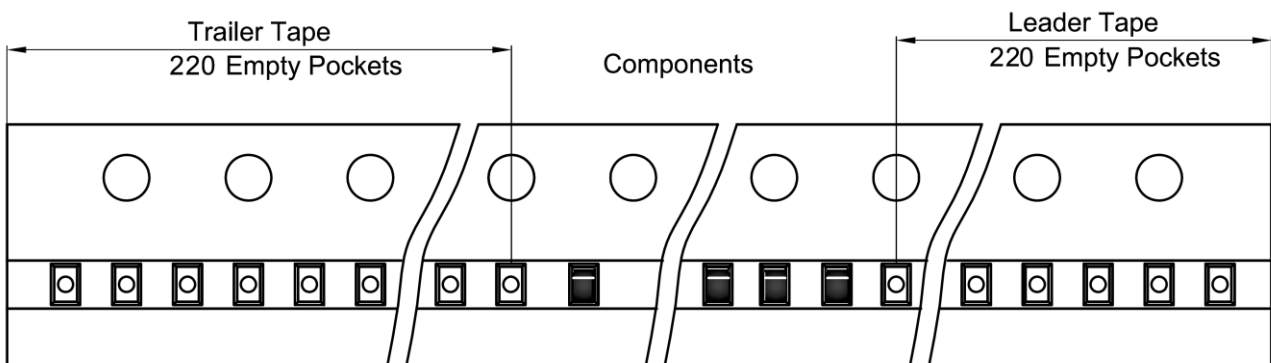

单击下面可查看定价，库存，交付和生命周期等信息

[>>GP\(格瑞宝\)](#)