

Product Summary

The GESDM12VY1 is designed to protect voltage sensitive electronic components from ESD and other transients. Excellent clamping capability, low leakage, low capacitance, and fast response time provide best in class protection on designs that are exposed to ESD.

The combination of small size, low capacitance, and high level of ESD protection makes them a flexible solution for applications such as HDMI, Display Port TM, and MDDI interfaces. It is designed to replace multiplayer varistors (MLV) in consumer equipments applications such as mobile phone, notebook, PAD, STB, LCD TV etc.

Feature

- Low reverse stand-off voltage: 12V
- Low reverse clamping voltage
- Ultra-low leakage current
- Fast response time
- IEC 61000-4-2 Level 4 ESD protection

Application

- Computers and peripherals
- Power lines
- Audio and video equipment
- Cellular handsets and accessories
- Portable electronics
- Other electronics equipments communication systems

Marking:

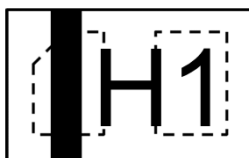

Front Side
H1 =Device Code

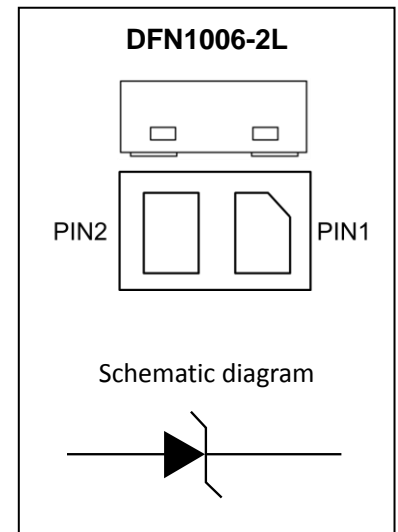

Absolute Maximum Ratings (Ta=25°C unless otherwise noted)

Parameter	Symbol	Value	Unit
IEC 61000-4-2 ESD Voltage	V _{ESD}	±30	kV
IEC 61000-4-2 ESD Voltage		±30	
JESD22-A114-B ESD Voltage		±16	
ESD Voltage		±0.4	
Peak Pulse Power (8/20μs)	P _{pk}	100	W
Peak Pulse Current (8/20μs)	I _{PP}	4	A
Junction Temperature	T _J	-55~ +125	°C
Storage Temperature	T _{stg}	-55~ +150	°C

ESD standards compliance

IEC61000-4-2 Standard

Contact Discharge		Air Discharge	
Level	Test Voltage kV	Level	Test Voltage kV
1	2	1	2
2	4	2	4
3	6	3	8
4	8	4	15

JESD22-A114-B Standard

ESD Class	Human Body Discharge V
0	0~249
1A	250~499
1B	500~999
1C	1000~1999
2	2000~3999
3A	4000~7999
3B	8000~15999

Contact discharge current waveform per IEC61000-4-2

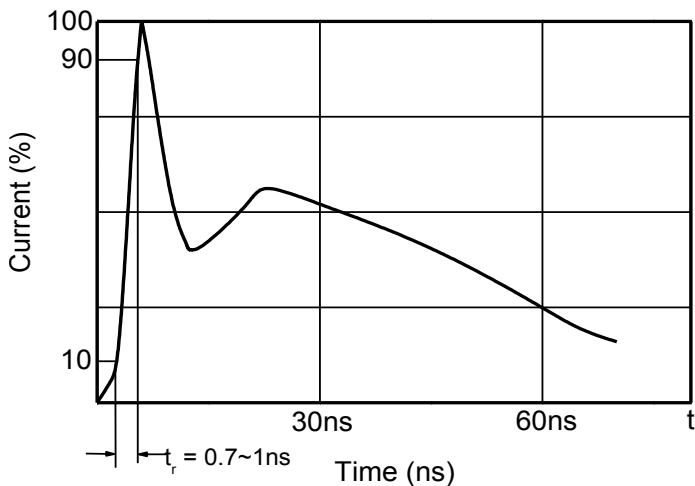

8/20μs waveform per IEC61000-4-5

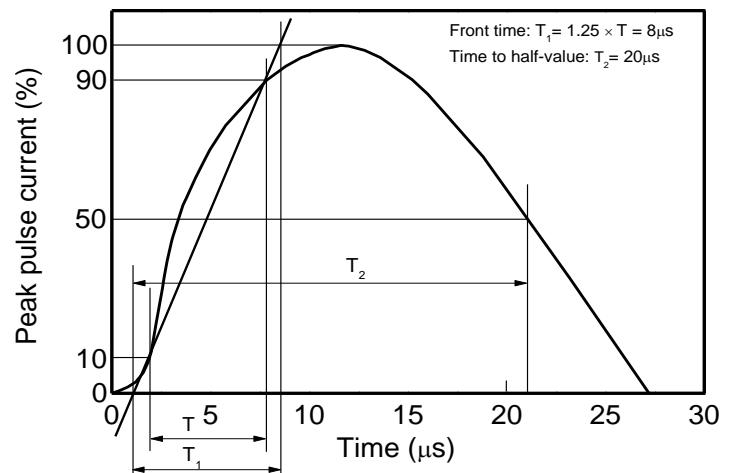

Electrical Parameter

Symbol	Parameter
V _C	Clamping Voltage @ I _{PP}
I _{PP}	Peak Pulse Current
V _{BR}	Breakdown Voltage @ I _T
I _T	Test Current
I _R	Reverse Leakage Current @ V _{RWM}
V _{RWM}	Reverse Standoff Voltage

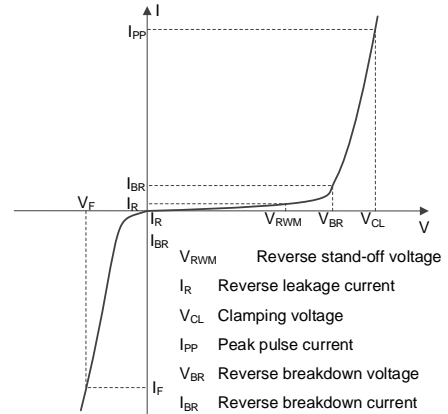

V-I characteristics for a Uni-directional TVS

Electrical Characteristics (T_a=25°C unless otherwise specified)

Parameter	Symbol	Test conditions	Min	Typ	Max	Unit
Reverse stand-off voltage	V _{RWM}				12	V
Reverse leakage current	I _R	V _{RWM} =3.3V			1	μA
Breakdown voltage	V _{BR}	I _T =1mA	13.5		17.5	V
Clamping voltage	V _{C1}	I _{PP} = 4A (8 x 20μs pulse)		25	29	V
Junction capacitance	C _J	V _R =0V, f=1MHz		21	30	pF

Typical Characteristics

V_C vs. I_{PP}

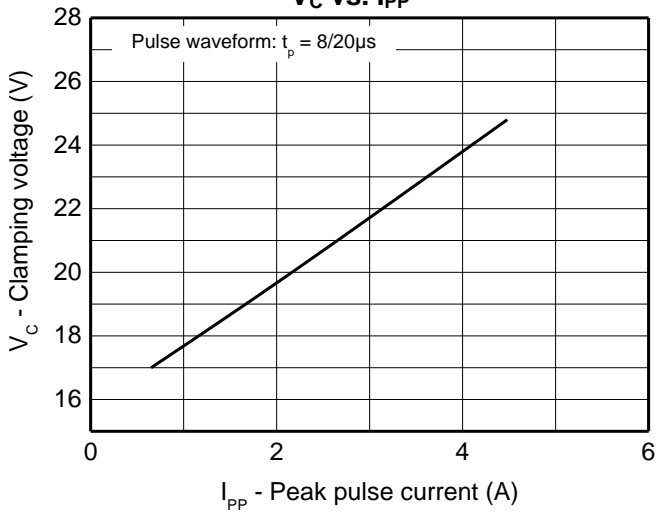

I-V Curve

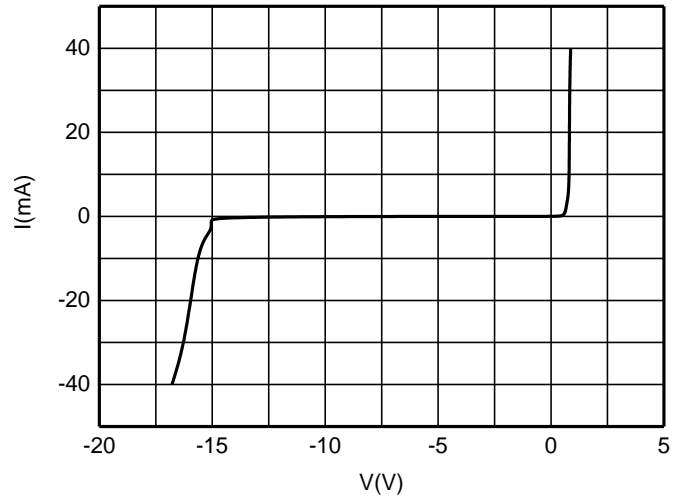

Peak pulse power vs. Pulse time

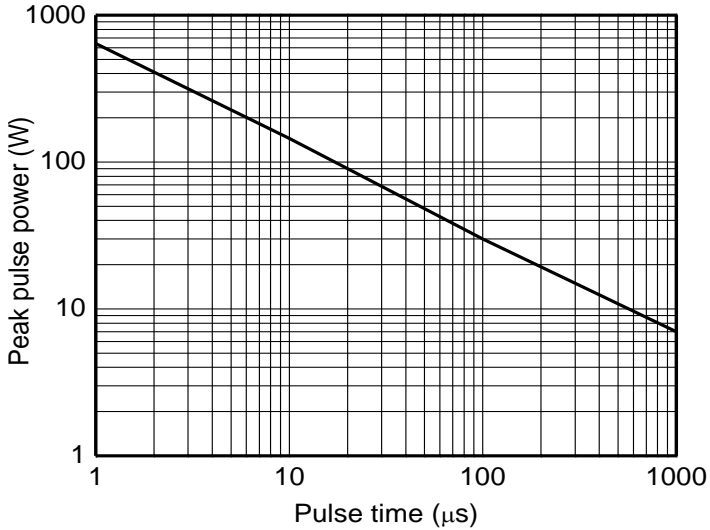

Power derating vs. Ambient temperature

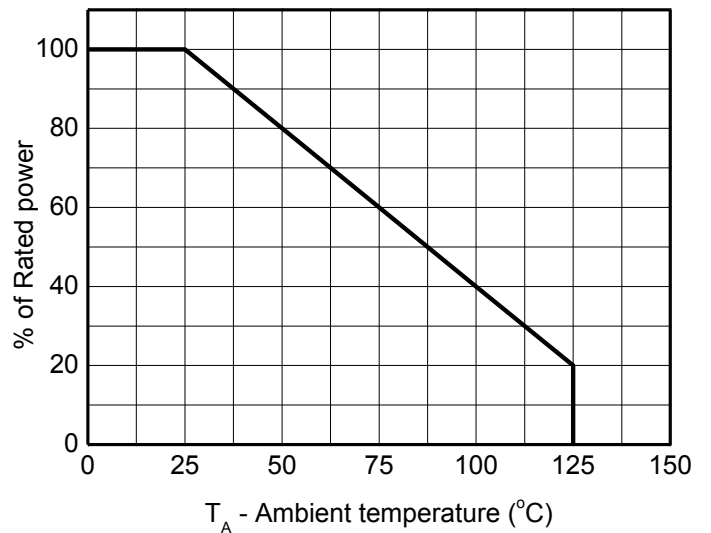

DFN0603-2L Package Outline Dimensions

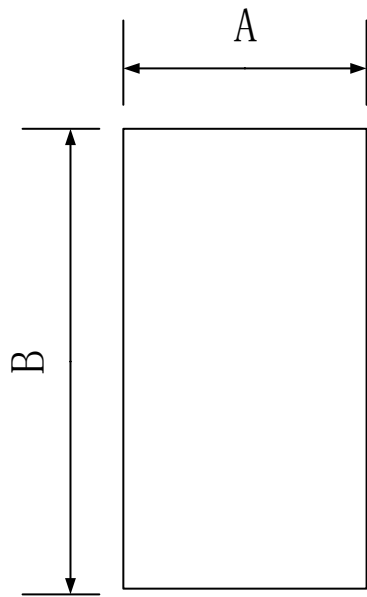

Top View

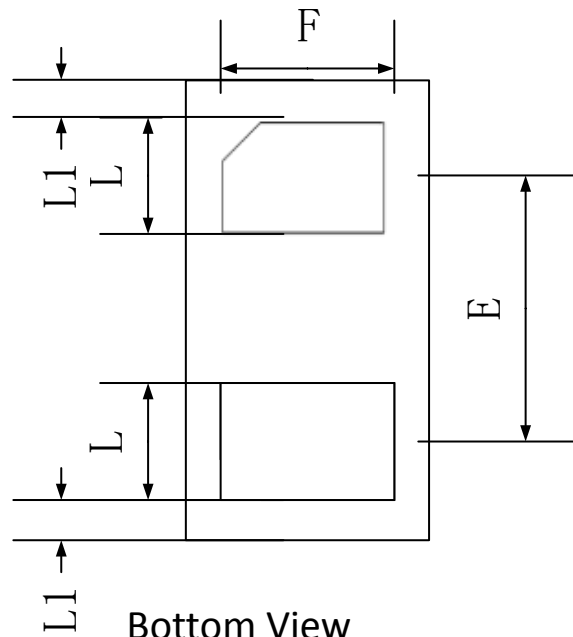

Bottom View

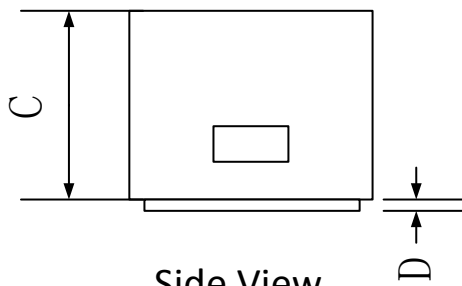

Side View

	Dimensions In Millimeters		
	Min.	Typ.	Max.
A	0.55	0.60	0.68
B	0.95	1.00	1.08
C	0.44	0.47	0.50
D	0.00	0.03	0.05
E	-	0.65	-
F	0.40	0.50	0.60
L	0.20	0.25	0.30
L1	0.05REF		

单击下面可查看定价，库存，交付和生命周期等信息

[>>GP\(格瑞宝\)](#)