

Product Summary

$V_{(BR)DSS}$	$R_{DS(on)TYP}$	I_D
-40V	63mΩ@-10V	-5.3A
	98mΩ@-4.5V	

Feature

- TrenchFET Power MOSFET
- Exceptional on-resistance and maximum DC current capability

Application

- DC/DC Converter
- Load Switch for Portable Devices
- Battery Switch

MARKING:

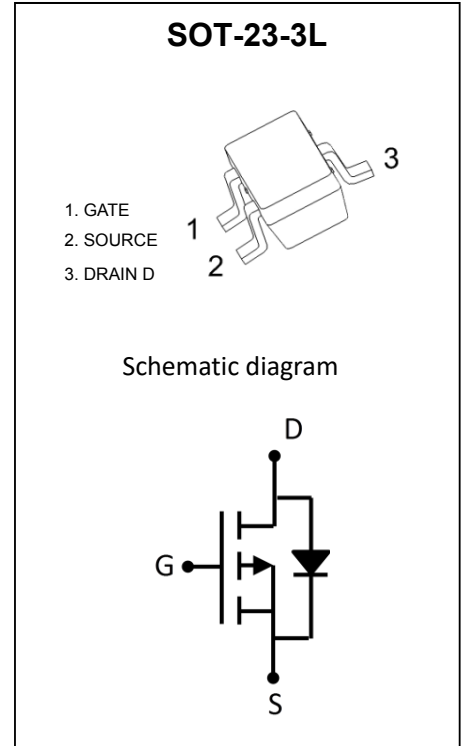
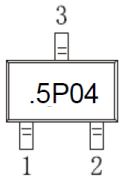

ABSOLUTE MAXIMUM RATINGS ($T_a=25^\circ\text{C}$ unless otherwise noted)

Parameter	Symbol	Value	Unit
Drain-Source Voltage	V_{DS}	-40	V
Gate-Source Voltage	V_{GS}	± 20	V
Continuous Drain Current	I_D	-5.3	A
Power Dissipation	P_D	0.45	W
Thermal Resistance from Junction to Ambient	$R_{\theta JA}$	313	$^\circ\text{C/W}$
Junction Temperature	T_J	150	$^\circ\text{C}$
Storage Temperature	T_{STG}	-55~ +150	$^\circ\text{C}$

MOSFET ELECTRICAL CHARACTERISTICS($T_a=25^{\circ}\text{C}$ unless otherwise noted)

Parameter	Symbol	Test Condition	Min	Type	Max	Unit
Static Characteristics						
Drain-source breakdown voltage	$V_{(BR)DSS}$	$V_{GS} = 0V, I_D = -250\mu A$	-40			V
Zero gate voltage drain current	I_{DSS}	$V_{DS} = -40V, V_{GS} = 0V$			-1	μA
Gate-body leakage current	I_{GSS}	$V_{GS} = \pm 20V, V_{DS} = 0V$			100	nA
Gate threshold voltage ⁽¹⁾	$V_{GS(th)}$	$V_{DS} = V_{GS}, I_D = -250\mu A$	-1.0	-2.1	-3.0	V
Drain-source on-resistance ⁽¹⁾	$R_{DS(on)}$	$V_{GS} = -10V, I_D = -5.0A$		63	82	m Ω
		$V_{GS} = -4.5V, I_D = -4.0A$		98	126	
Forward transconductance	g_{FS}	$V_{DS} = -5V, I_D = -4.1A$	7			S
Dynamic characteristics ⁽²⁾						
Input Capacitance	C_{iss}	$V_{DS} = -20V, V_{GS} = 0V, f = 1MHz$		650		pF
Output Capacitance	C_{oss}			90		
Reverse Transfer Capacitance	C_{rss}			70		
Total Gate Charge	Q_g	$V_{DS} = -20V, I_D = -3.1A, V_{GS} = -10V$		14		nC
Gate-Source Charge	Q_{gs}			2.9		
Gate-Drain Charge	Q_{gd}			3.8		
Switching characteristics ⁽²⁾						
Turn-on delay time	$t_{d(on)}$	$V_{DD} = -20V, R_L = 2\Omega$ $V_{GS} = -10V, R_{GEN} = 3\Omega$		8		ns
Turn-on rise time	t_r			9		
Turn-off delay time	$t_{d(off)}$			28		
Turn-off fall time	t_f			10		
Source-Drain Diode characteristics						
Diode Forward voltage ⁽¹⁾	V_{DS}	$V_{GS} = 0V, I_S = -2.5A$		-0.87	-1.2	V

Notes:

1. Pulse test; pulse width $\leq 300\mu s$, duty cycle $\leq 2\%$.
2. Guaranteed by design, not subject to production testing.

Typical Electrical and Thermal Characteristics

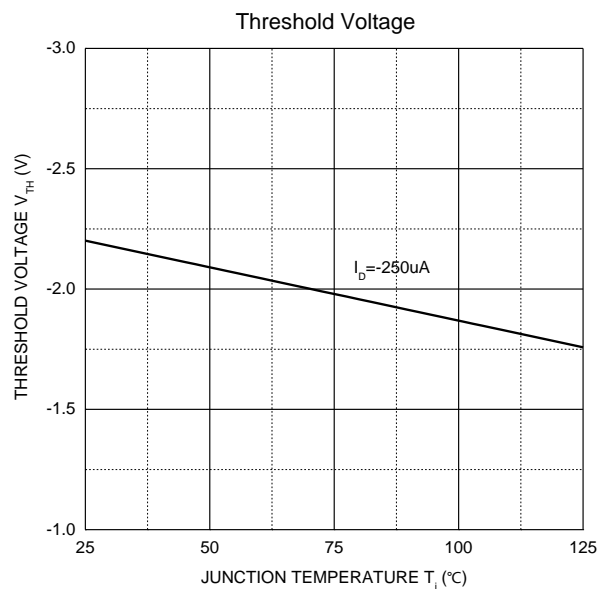
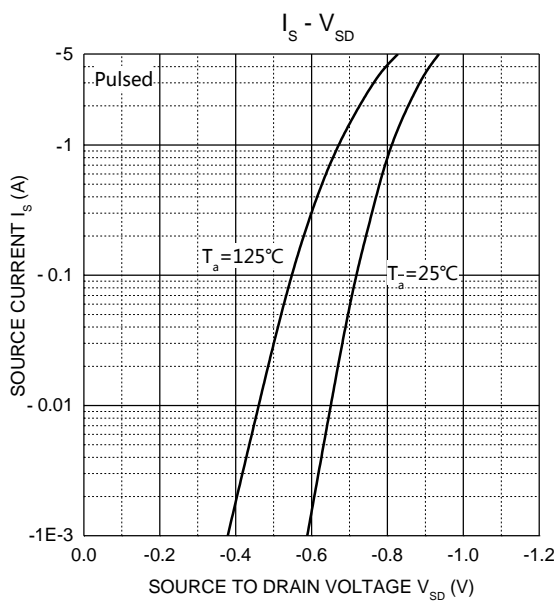
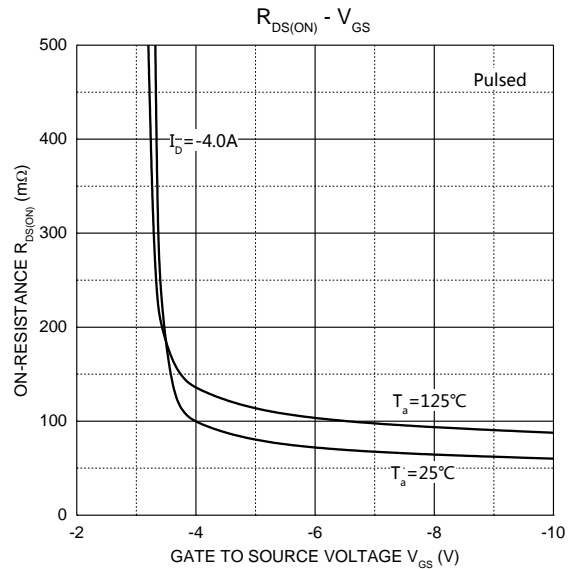
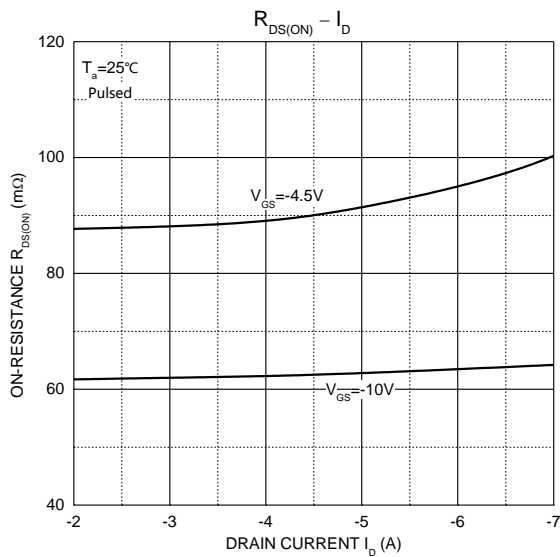
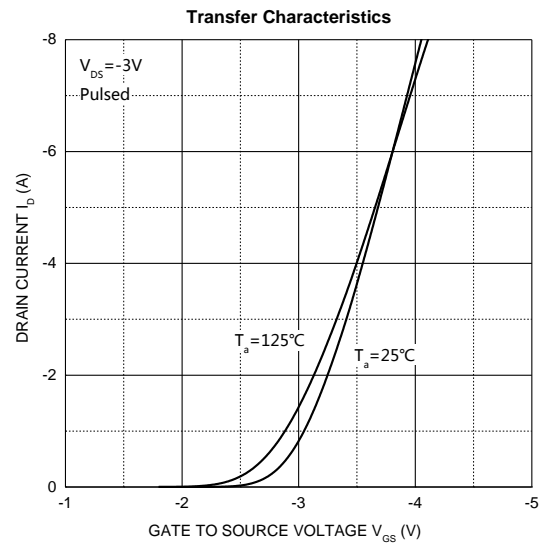
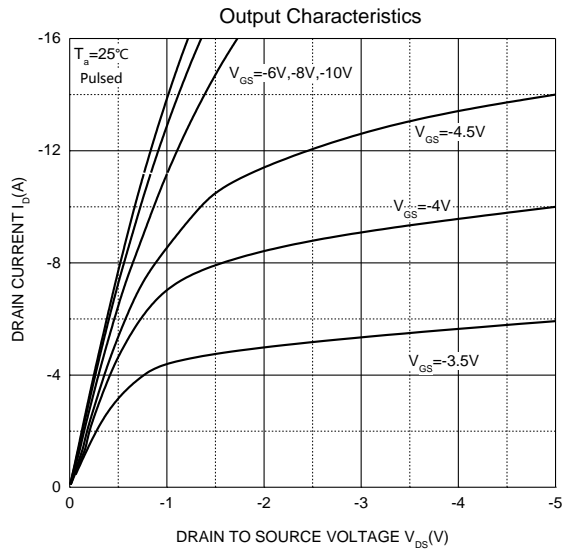

SOT-23-3L Package Information

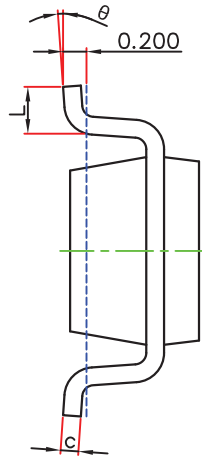
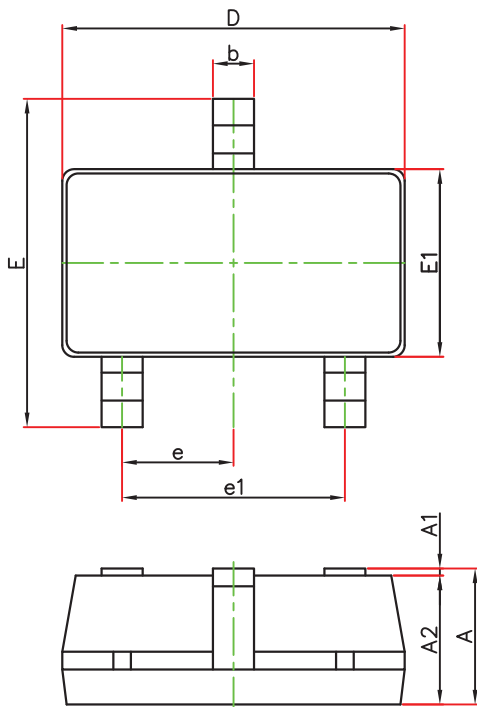

Symbol	Dimensions In Millimeters		Dimensions In Inches	
	Min.	Max.	Min.	Max.
A	1.050	1.250	0.041	0.049
A1	0.000	0.100	0.000	0.004
A2	1.050	1.150	0.041	0.045
b	0.300	0.500	0.012	0.020
c	0.100	0.200	0.004	0.008
D	2.820	3.020	0.111	0.119
E1	1.500	1.700	0.059	0.067
E	2.650	2.950	0.104	0.116
e	0.950(BSC)		0.037(BSC)	
e1	1.800	2.000	0.071	0.079
L	0.300	0.600	0.012	0.024
θ	0°	8°	0°	8°

SOT-23 Tape and Reel

SOT-23-3L Embossed Carrier Tape

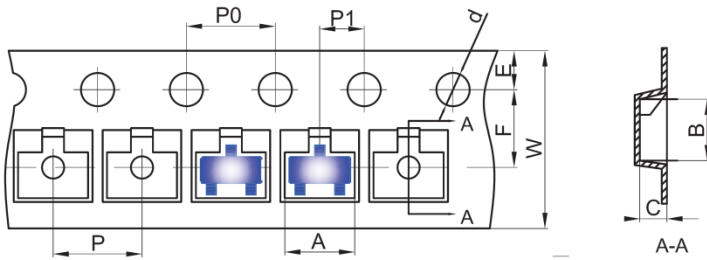

Dimensions are in millimeter											
Pkg type	A	B	C	d	E	F	P0	P	P1	W	
SOT-23-3L	3.18	3.28	1.32	Ø1.50	1.75	3.50	4.00	4.00	2.00	8.00	

SOT-23-3L Tape Leader and Trailer

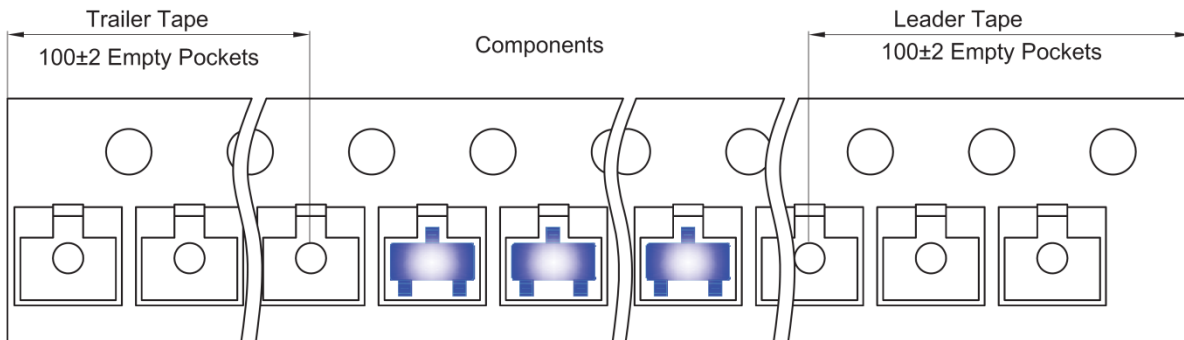

SOT-23-3L Reel

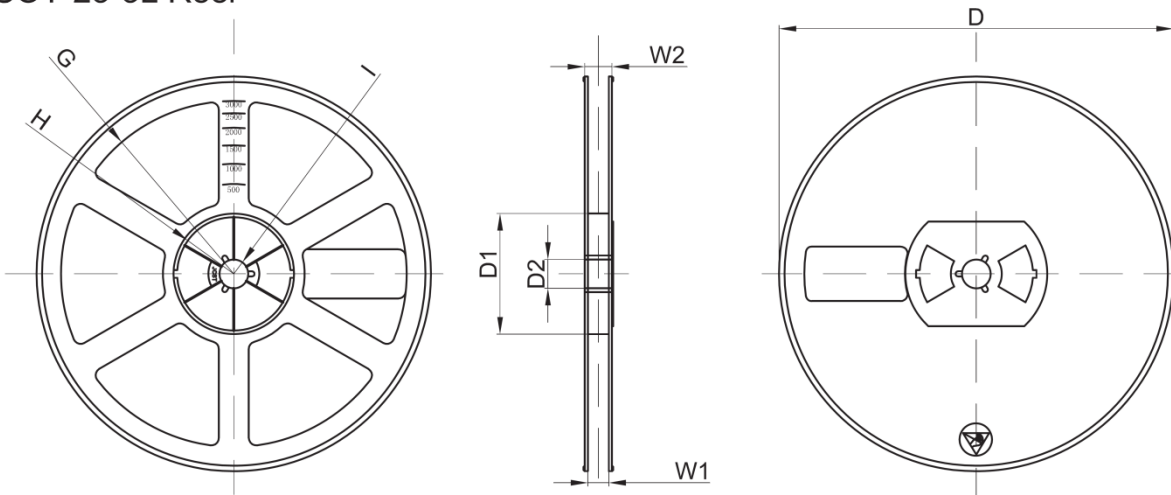

Dimensions are in millimeter								
Reel Option	D	D1	D2	G	H	I	W1	W2
7" Dia	Ø180.00	60.00	13.00	R78.00	R25.60	R6.50	9.50	13.10

REEL	Reel Size	Box	Box Size(mm)	Carton	Carton Size(mm)	G.W.(kg)
3000 pcs	7 inch	30,000 pcs	203×203×195	120,000 pcs	438×438×220	

单击下面可查看定价，库存，交付和生命周期等信息

[>>GP\(格瑞宝\)](#)